



General Catalog

2021

 **vilmers**

Symbols

Legend

Design your dream sofa

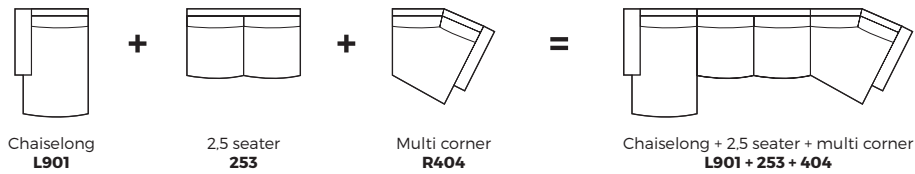

Back cushion selection

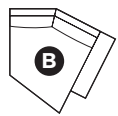

Multi corner B
L405B / R404B



Multi corner P
L405P / R404P

Headrest & seat type

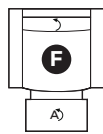

1.5 seater
150F

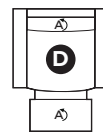

1.5 seater
150D

↶ - manual *F - single electric function
⚡ - electrical *D - double electric function

Multicolor options

■ Color A
■ Color B
■ Color C

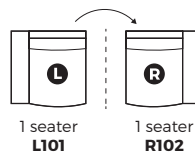
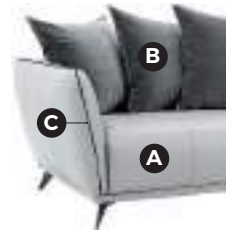

Parts and sets shown in 2D drawings are left-sided.
Parts and sets can be mirrored from left to right.

Furniture features in symbols



1



2



3



4



5



6



7



8



9



10

1. Sleeping function.
2. Seat & back cushions are fixed to the frame.
3. Seat & back cushions are loose from the frame.
4. Relax function: seat and headrest motion, mechanical or electrical.
5. Bonnell pocket springs.
6. Natural feathers.
7. Storage.
8. Loose back and fixed seat.
9. Loose seat and fixed back.
10. Removable cover for loose cushions.*
(* For maintenance please check fabric information.)

Alba



Alba



Comfort

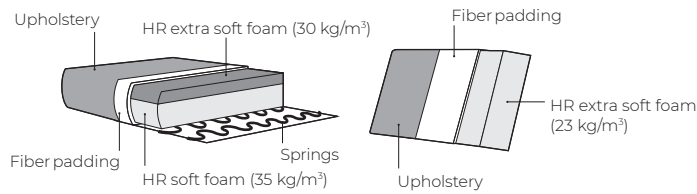

1. Upholstery



2. Appearance



3. Legs



IMPORTANT:

Upholstered furniture is handmade using soft materials therefore measurements may vary up to **+/- 5 cm**.
Parts and sets shown in 2D drawings are left-sided. Parts and sets can be mirrored from left to right.

Sets

Scale 1:100

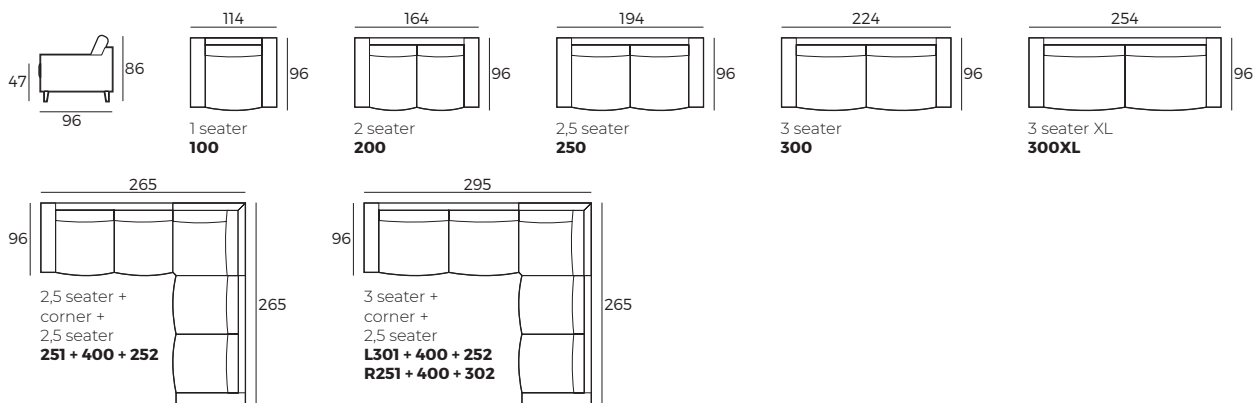

Accessories

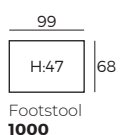

CUSTOM MADE COMFORT

Alvar



Alvar



Comfort

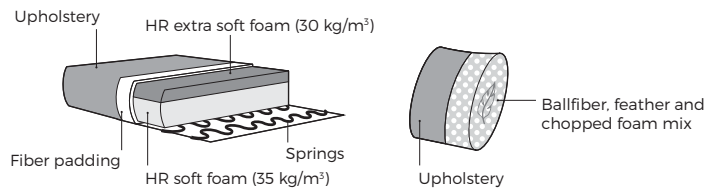

1. Upholstery

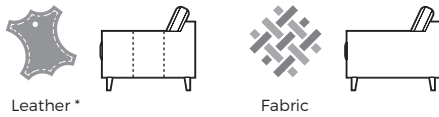

* Leather covers may require more stitches than fabric covers.

2. Legs



IMPORTANT:

Upholstered furniture is handmade using soft materials therefore measurements may vary up to +/- 5 cm.
Parts and sets shown in 2D drawings are left-sided. Parts and sets can be mirrored from left to right.

Single parts

Scale 1:100

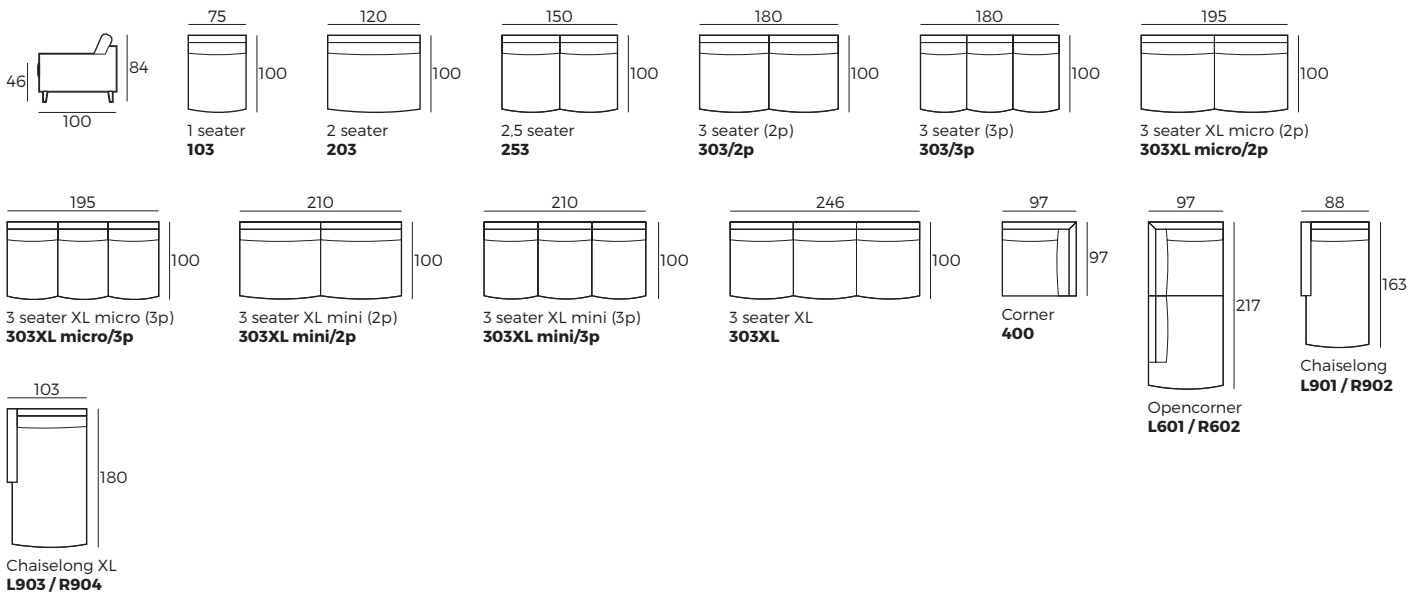

CUSTOM MADE COMFORT

Alvar

Scale 1:100

Half sets

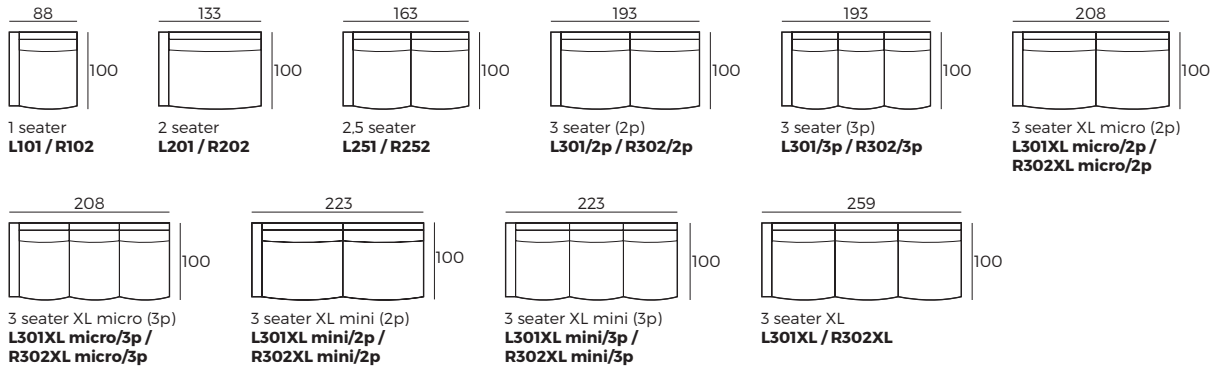

Sets

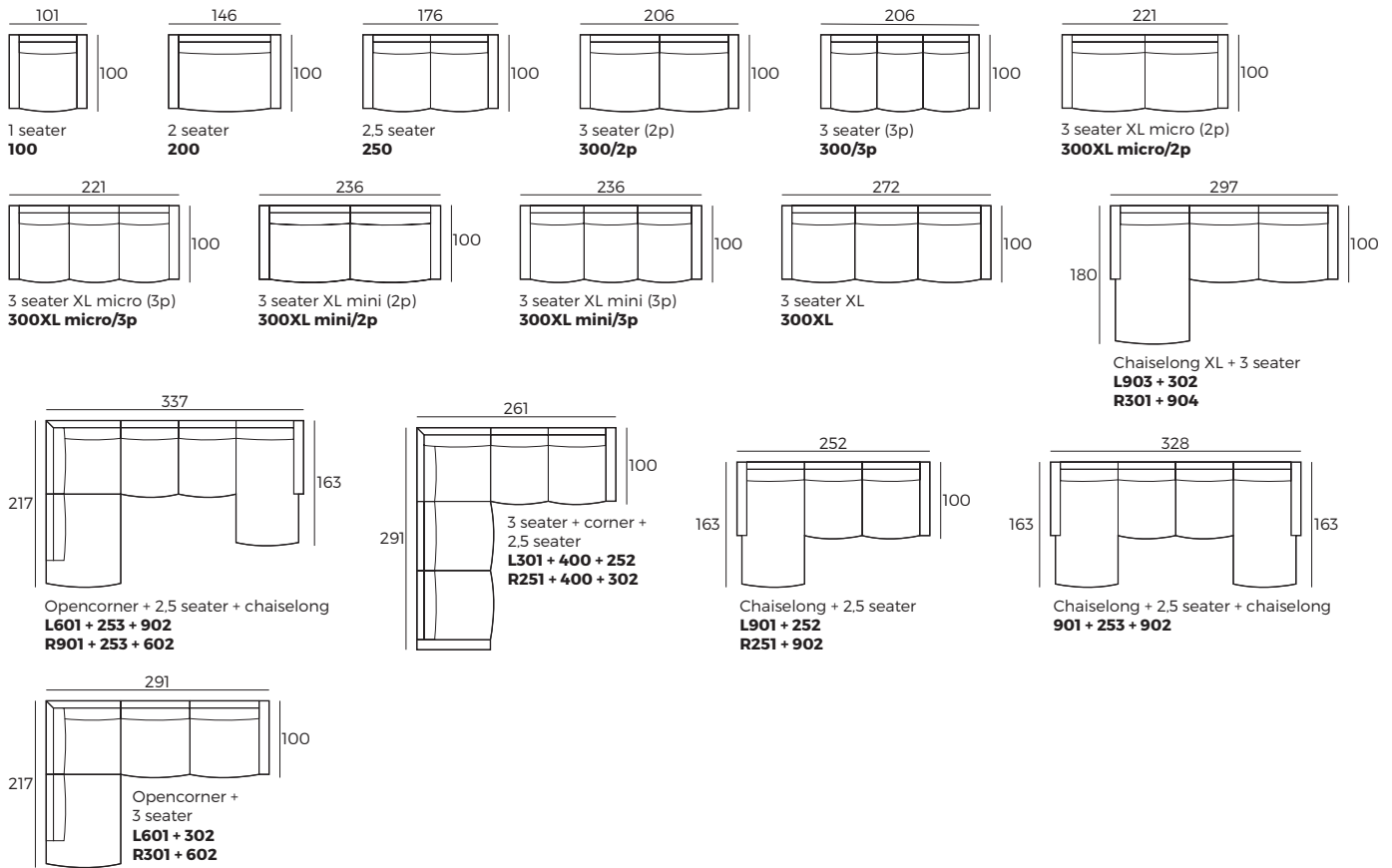

Accessories

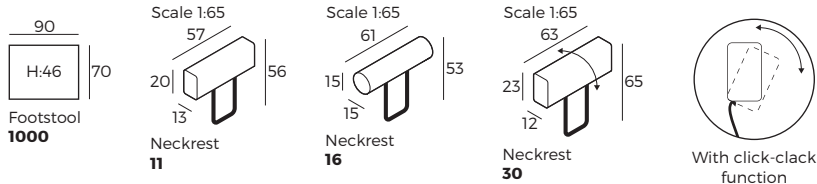

Ambition



Ambition



Comfort

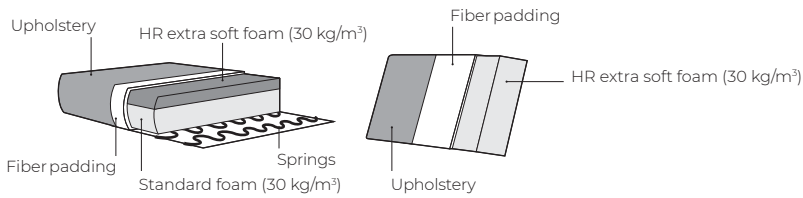

1. Upholstery



* Leather covers may require more stitches than fabric covers.

2. Headrest & seat type

*Measures with fully opened mechanism

- 1 Manual ↶ / Electrical ↷
- 2 Electrical ↷

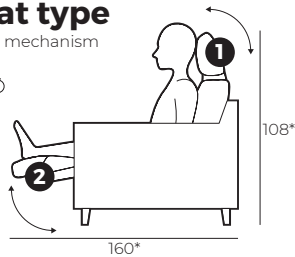

4. Bi-Color option

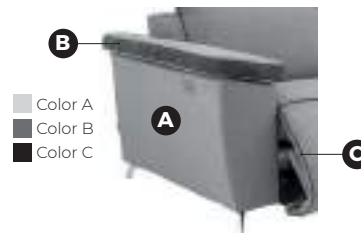

5. Legs



IMPORTANT:

Upholstered furniture is handmade using soft materials therefore measurements may vary up to +/- 5 cm.
Parts and sets shown in 2D drawings are left-sided. Parts and sets can be mirrored from left to right.

Single parts

Scale 1:100

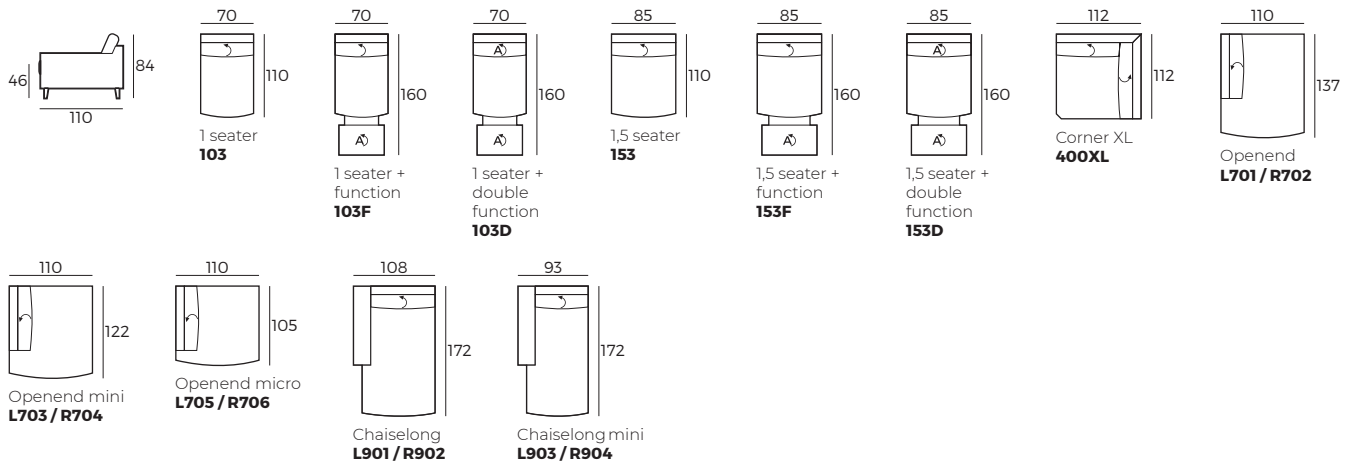

Ambition

Half sets

Scale 1:100

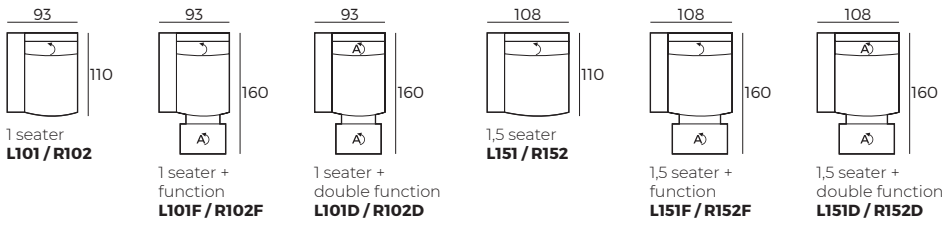

Sets

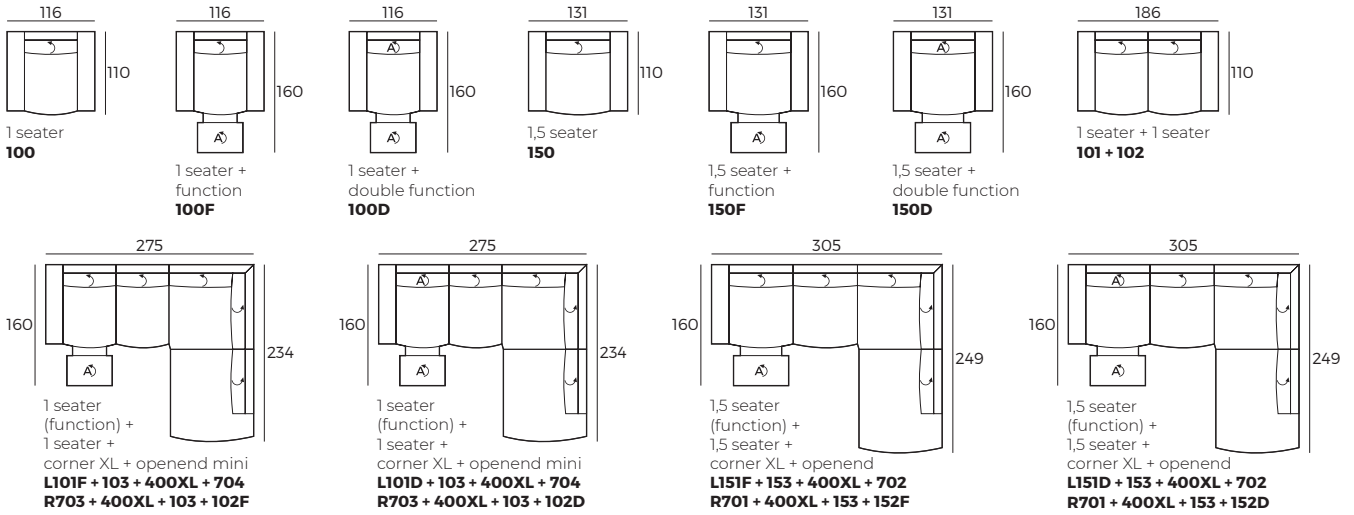

Accessories

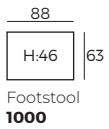

⌋ - manual; ⌋ - electrical *F - single electric function; *D - double electric function

Avio



Avio



Comfort

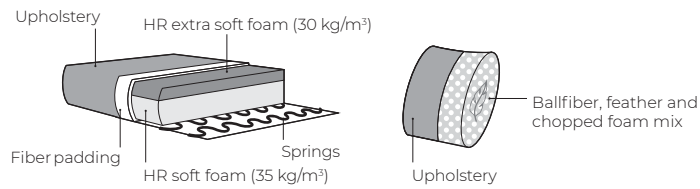

1. Upholstery



* Leather covers may require more stitches than fabric covers.

2. Legs

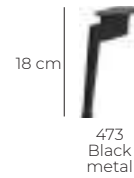

IMPORTANT:

Upholstered furniture is handmade using soft materials therefore measurements may vary up to +/- 5 cm.
Parts and sets shown in 2D drawings are left-sided. Parts and sets can be mirrored from left to right.

Sets

Scale 1:100

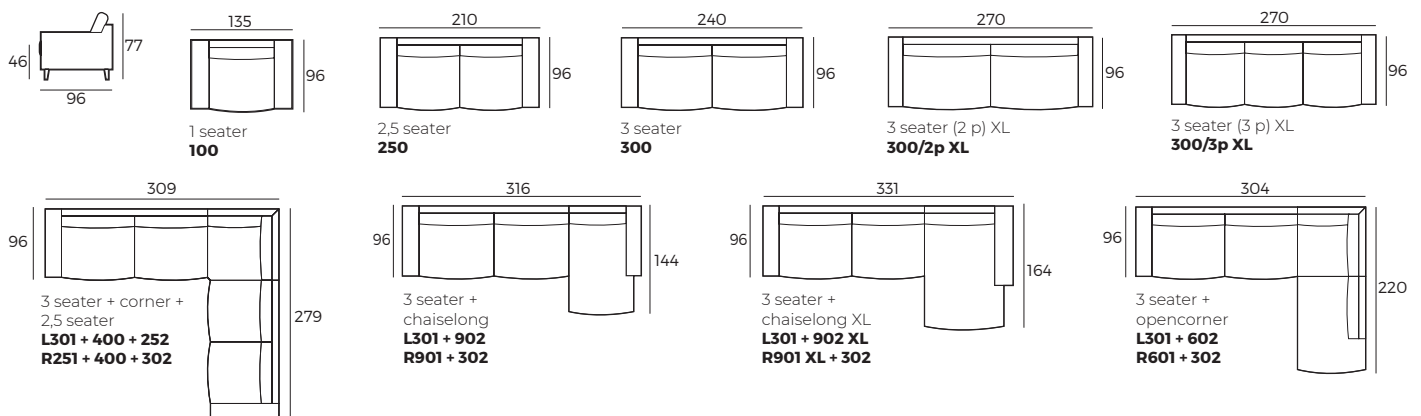

Accessories

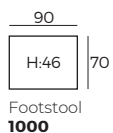

Footstool
1000

CUSTOM MADE COMFORT

Bella



Bella



Comfort

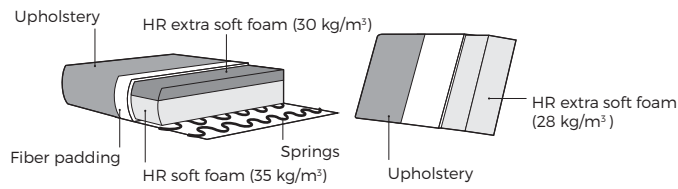

1. Upholstery

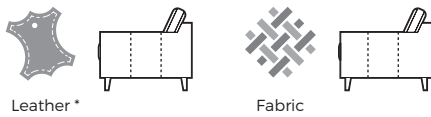

Leather*

Fabric

* Leather and fabric upholstery contains the same number of stitches.

2. Legs

12 cm



394
Black
metal



504
Metal

IMPORTANT:

Upholstered furniture is handmade using soft materials therefore measurements may vary up to **+/- 5 cm**.
Parts and sets shown in 2D drawings are left-sided. Parts and sets can be mirrored from left to right.

Single parts

Scale 1:100

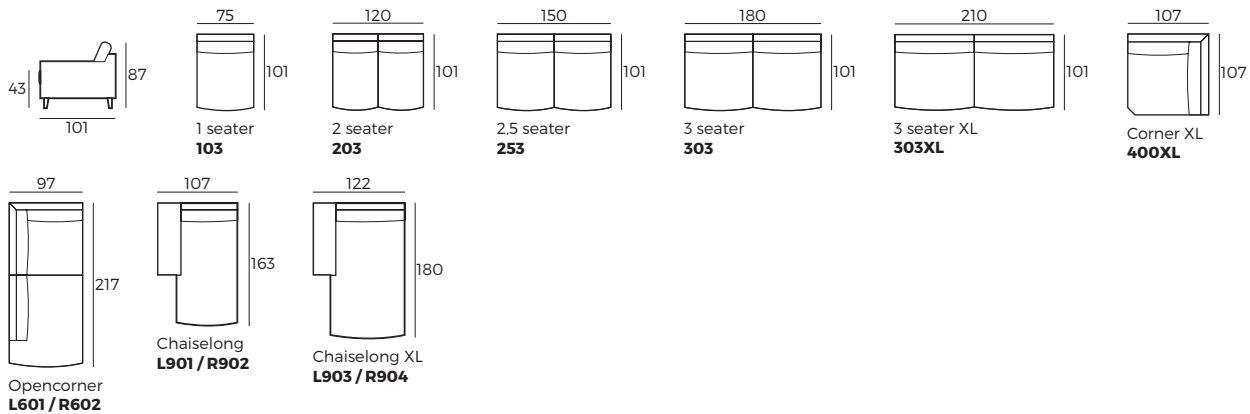

Bella

Half sets

Scale 1:100

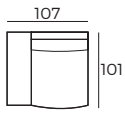

1 seater
L101 / R102

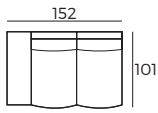

2 seater
L201 / R202

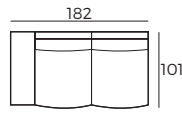

2.5 seater
L251 / R252

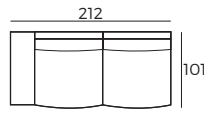

3 seater
L301 / R302

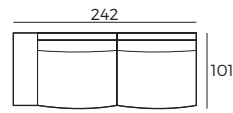

3 seater XL
L301XL / R302XL

Sets

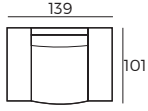

1 seater
100

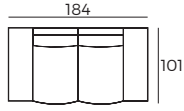

2 seater
200

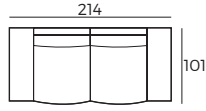

2.5 seater
250

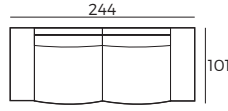

3 seater
300

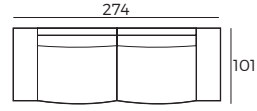

3 seater XL
300XL

Accessories

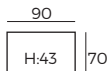

Footstool
1000

Bird



Bird



Comfort

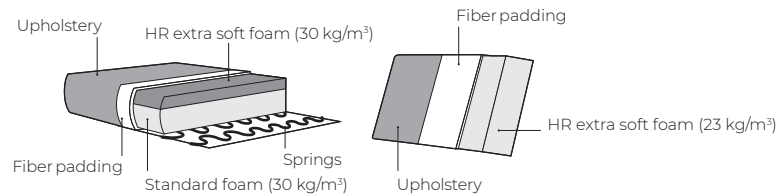

1. Upholstery



* Leather covers may require more stitches than fabric covers.

2. Headrest & seat type

*Measures with fully opened mechanism

- 1 Manual ↷ / Electrical ↻
- 2 Electrical ↻

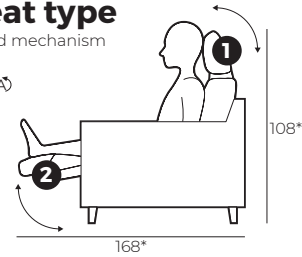

3. Bi-Color option

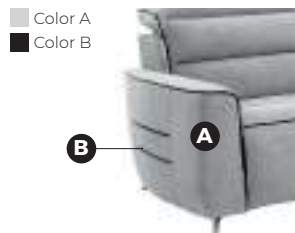

4. Legs



IMPORTANT:

Upholstered furniture is handmade using soft materials therefore measurements may vary up to +/- 5 cm.
Parts and sets shown in 2D drawings are left-sided. Parts and sets can be mirrored from left to right.

Single parts

Scale 1:100

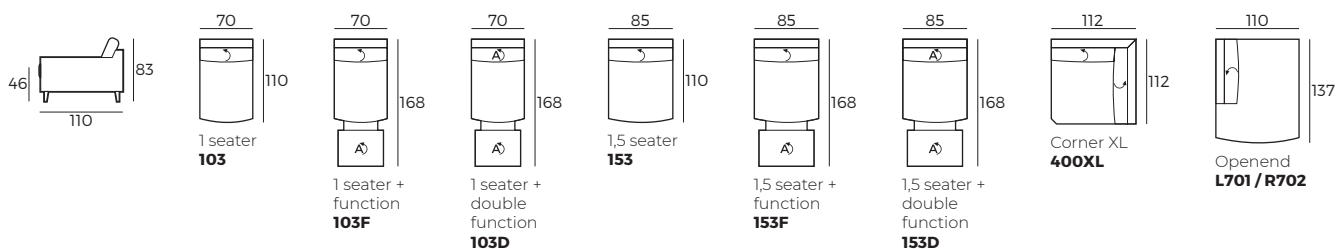

CUSTOM MADE COMFORT

Bird

Scale 1:100

Single parts

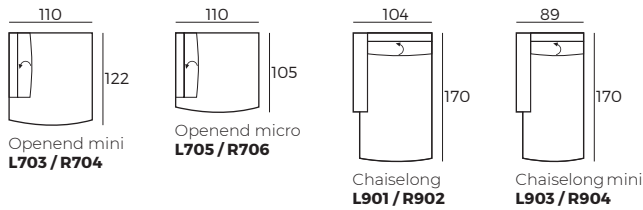

Half sets

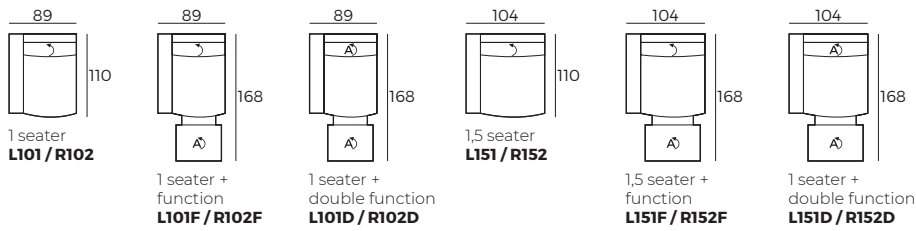

Sets

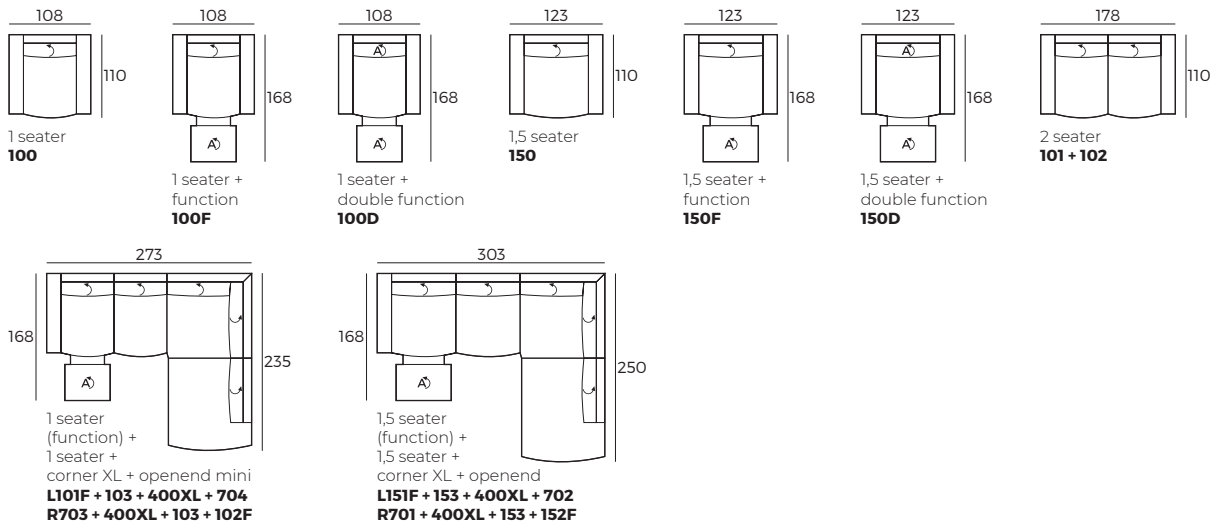

Accessories

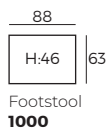

↷ - manual; Ⓐ - electrical *F - single electric function; *D - double electric function

Bluemary



Bluemary



Comfort

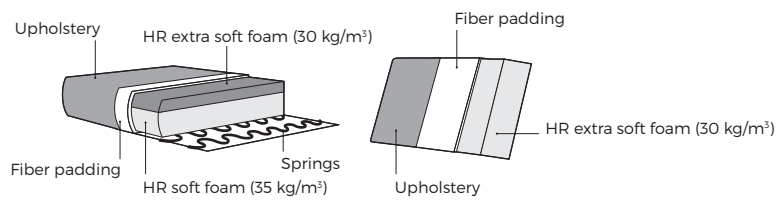

1. Upholstery



Leather*

Fabric*

* Leather and fabric upholstery contains the same number of stitches.

2. Legs



IMPORTANT:

Upholstered furniture is handmade using soft materials therefore measurements may vary up to +/- 5 cm.
Parts and sets shown in 2D drawings are left-sided. Parts and sets can be mirrored from left to right.

Single parts

Scale 1:100

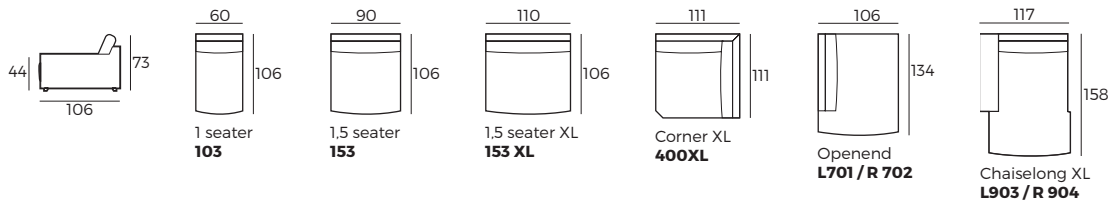

Half sets

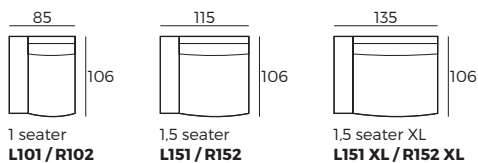

CUSTOM MADE COMFORT

Bluemary

Sets

Scale 1:100

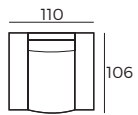

1 seater
100

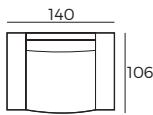

1,5 seater
150

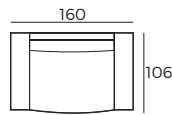

1,5 seater XL
150 XL

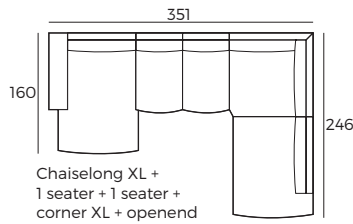

Chaiselong XL +
1 seater + 1 seater +
corner XL + openend
L903 + 103 + 103 + 400XL + 702
R701 + 400XL + 103 + 103 + 904

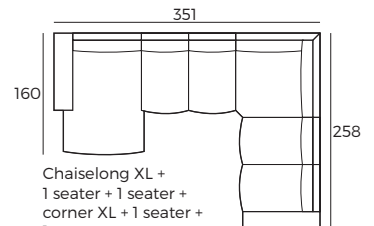

Chaiselong XL +
1 seater + 1 seater +
corner XL + 1 seater +
1 seater
L903 + 103 + 103 + 400XL + 103 + 102
R101 + 103 + 400XL + 103 + 103 + 904

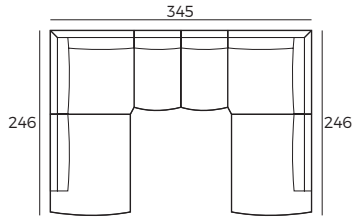

Openend + corner XL + 1 seater +
1 seater + corner XL + openend
701 + 400XL + 103 + 103 + 400XL + 702

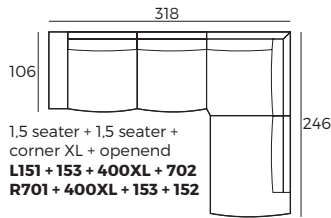

1,5 seater + 1,5 seater +
corner XL + openend
L151 + 153 + 400XL + 702
R701 + 400XL + 153 + 152

Accessories

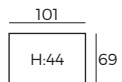

Footstool
1000

Boston



Boston



Comfort

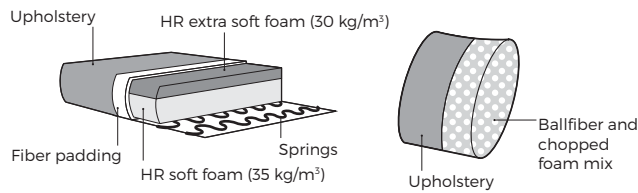

1. Upholstery



2. Armrests



Street

W 25 x D 97 x H 64

Boston

W 27 x D 97 x H 64

Miami

W 29 x D 99 x H 63

Chill

W 30 x D 97 x H 60

3. Choose pillows



Pillow **B**

Pillow **P**

4. Legs



* The height of all legs can be either 3 cm or 6 cm.

IMPORTANT:

Upholstered furniture is handmade using soft materials therefore measurements may vary up to +/- 5 cm.
Parts and sets shown in 2D drawings are left-sided. Parts and sets can be mirrored from left to right.

Single parts (Measurements with Boston armrest)

Scale 1:100

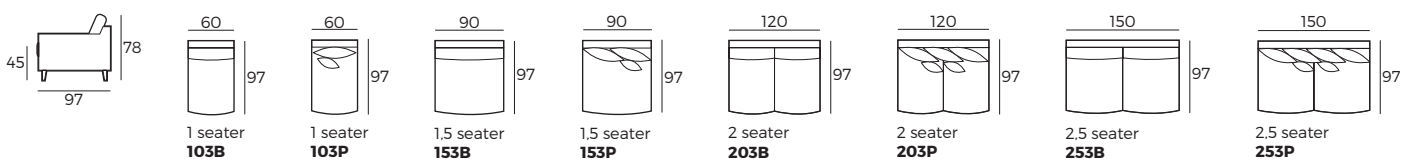

CUSTOM MADE COMFORT

Boston

Single parts (Measurements with Boston armrest)

Scale 1:100

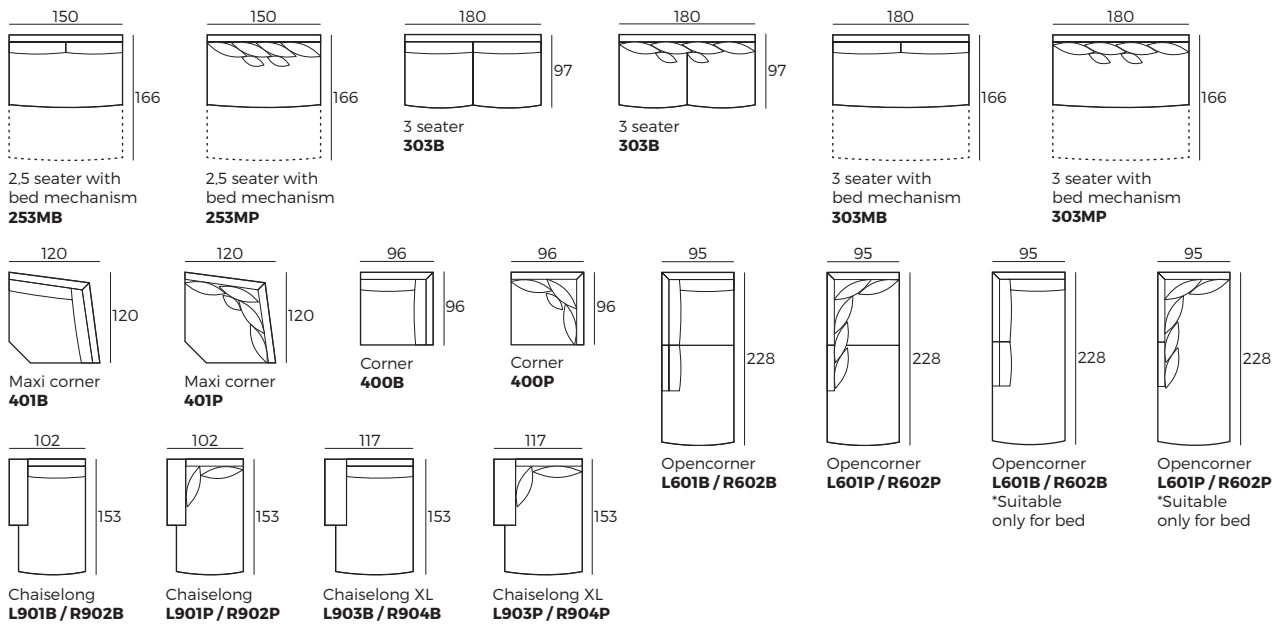

Half sets (Measurements with Boston armrest)

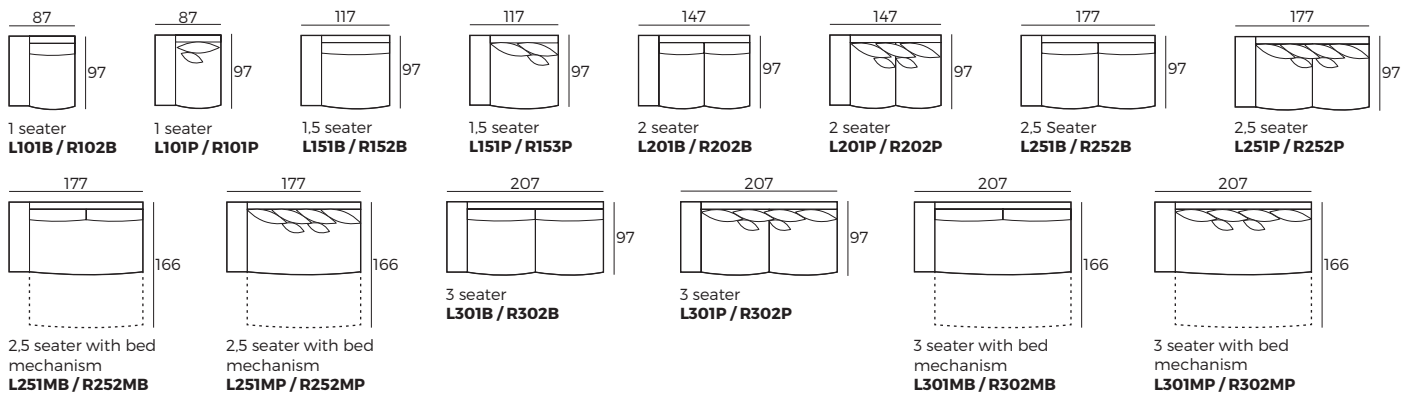

Sets (Measurements with Boston armrest)

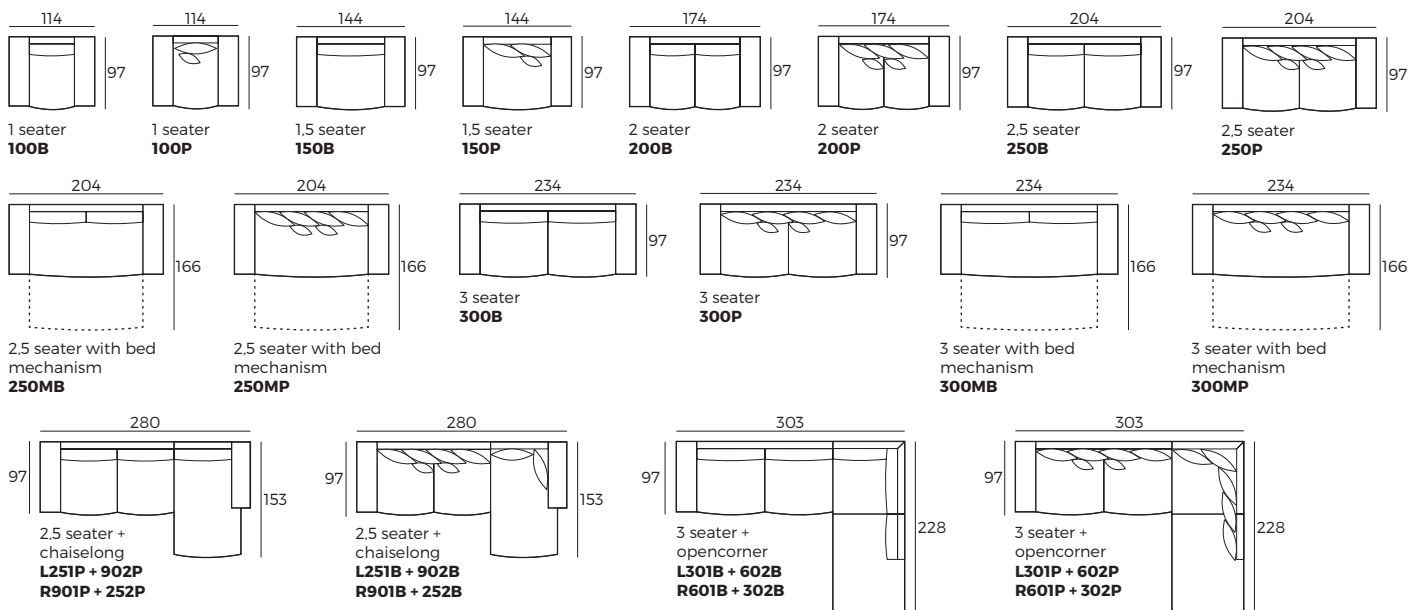

Boston

Accessories

Scale 1:100

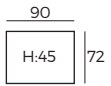

Footstool
1000

Brandy



Brandy



Comfort

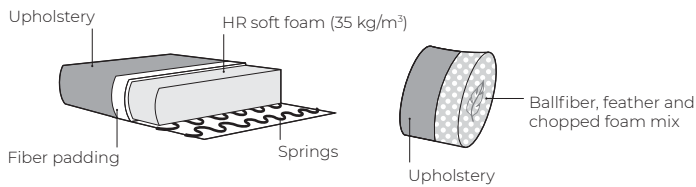

1. Upholstery

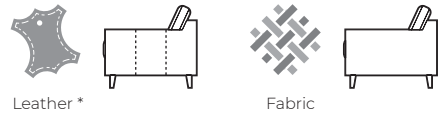

* Leather covers may require more stitches than fabric covers.

2. Bi-Color option

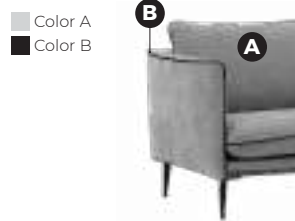

3. Legs



IMPORTANT:

Upholstered furniture is handmade using soft materials therefore measurements may vary up to ± 5 cm.
Parts and sets shown in 2D drawings are left-sided. Parts and sets can be mirrored from left to right.

Single parts

Scale 1:100

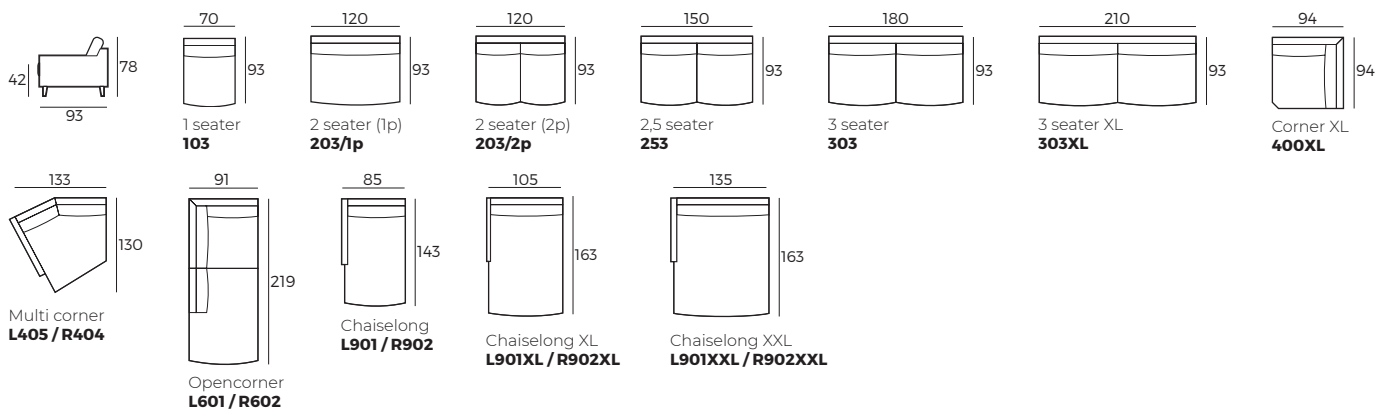

Brandy

Scale 1:100

Half sets

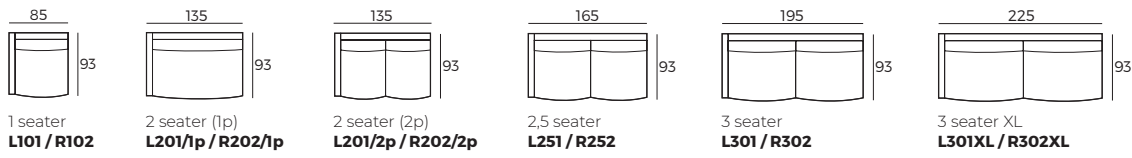

Sets

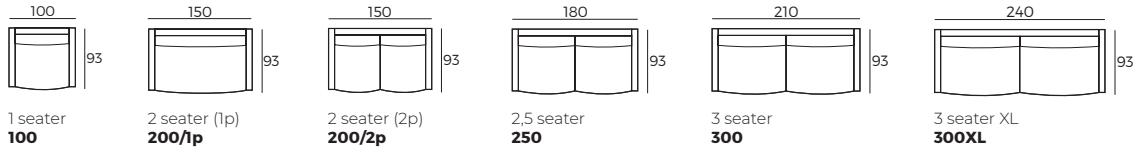

Accessories

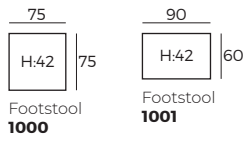

Brera



Brera



Comfort

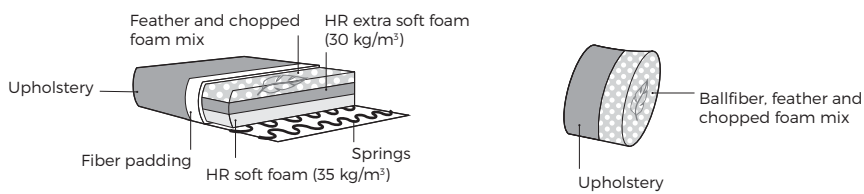

1. Upholstery

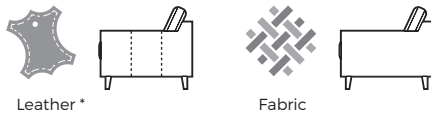

* Leather covers may require more stitches than fabric covers.

2. Legs

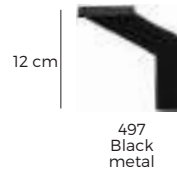

IMPORTANT:

Upholstered furniture is handmade using soft materials therefore measurements may vary up to +/- 5 cm.
Parts and sets shown in 2D drawings are left-sided. Parts and sets can be mirrored from left to right.

Single parts

Scale 1:100

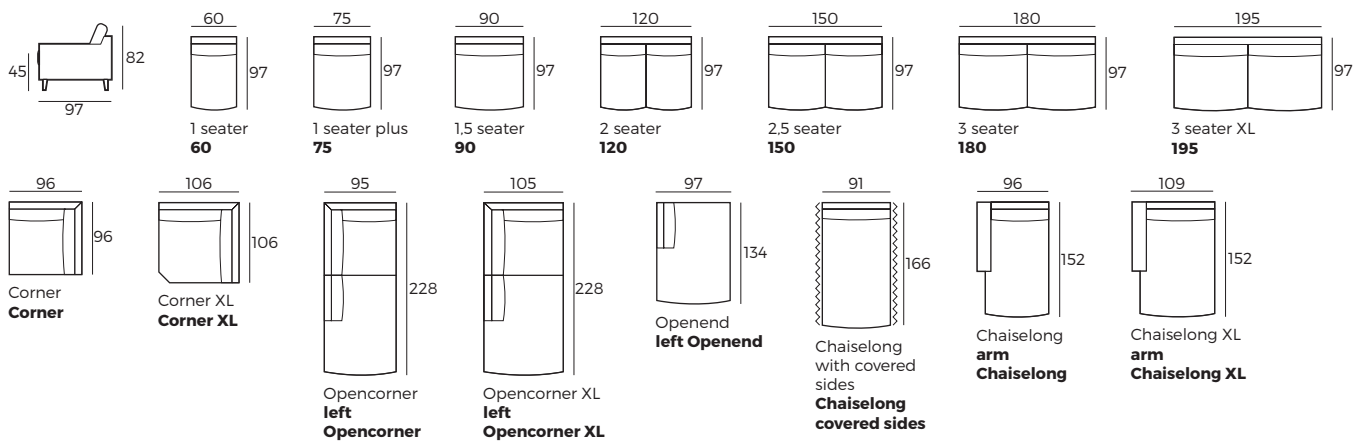

Half sets

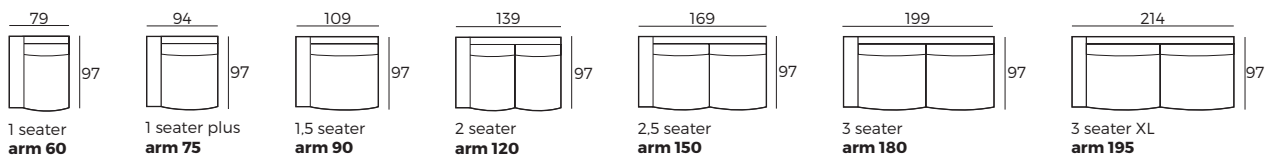

CUSTOM MADE COMFORT

Brera

Sets

Scale 1:100

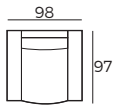

1 seater
arm 60 arm

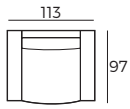

1 seater plus
arm 75 arm

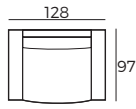

1,5 seater
arm 90 arm

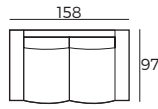

2 seater
arm 120 arm

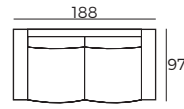

2,5 seater
arm 150 arm

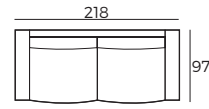

3 seater
arm 180 arm

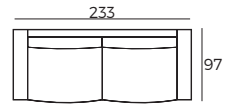

3 seater XL
arm 195 arm

Accessories



Footstool
**Footstool
69x45**

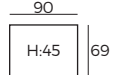

Footstool
**Footstool
90x69**

Canyon



Canyon



Comfort

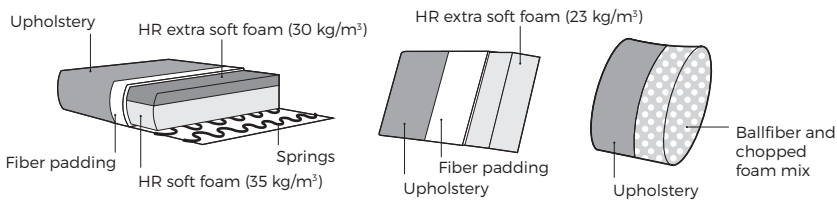

1. Upholstery

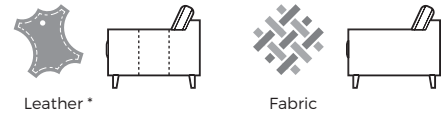

* Leather covers may require more stitches than fabric covers.

2. Multicolor Option



3. Choose pillows

Multi corner



Pillow P

Pillow B

4. Legs



394 Black metal



IMPORTANT:

Upholstered furniture is handmade using soft materials therefore measurements may vary up to +/- 5 cm.
Parts and sets shown in 2D drawings are left-sided. Parts and sets can be mirrored from left to right.

Single parts

Scale 1:100

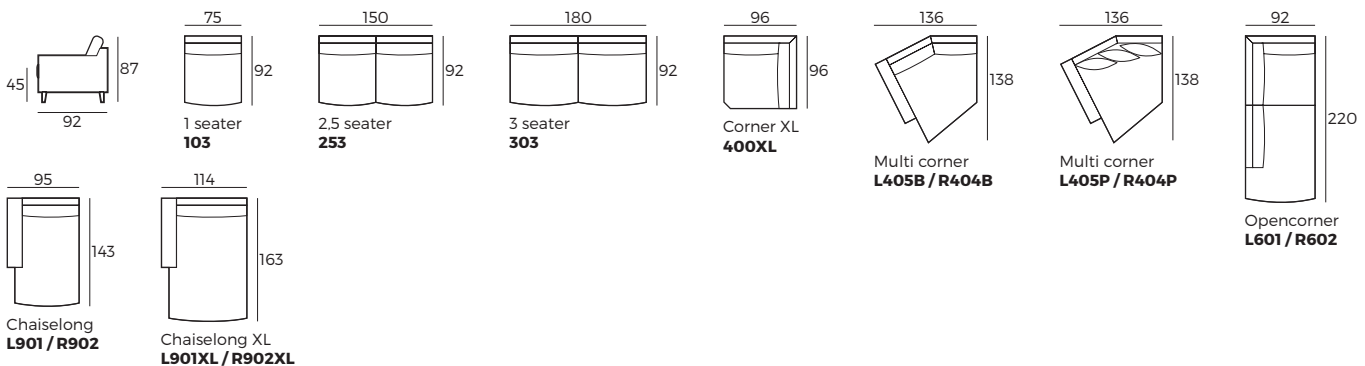

Half sets

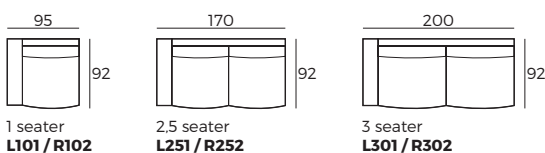

CUSTOM MADE COMFORT

Canyon

Sets

Scale 1:100

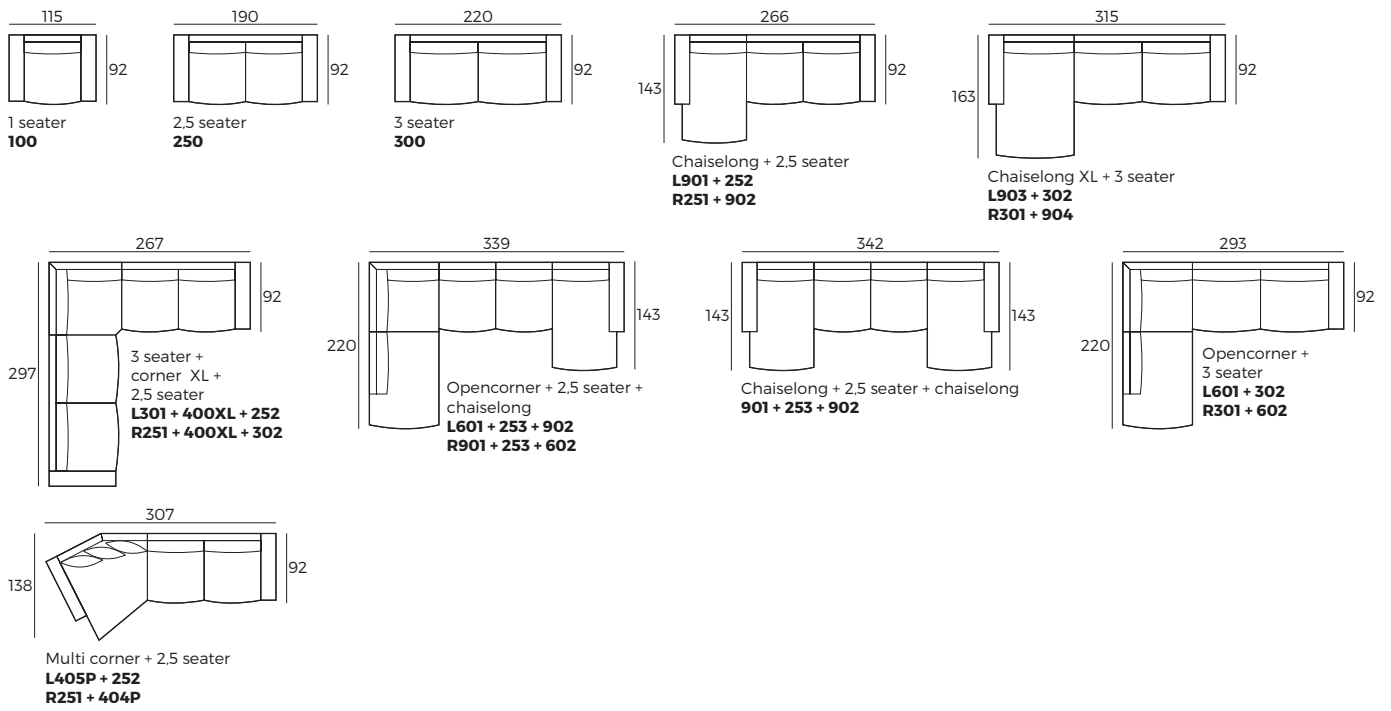

Accessories

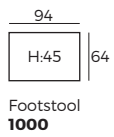

Cara



Cara



Comfort

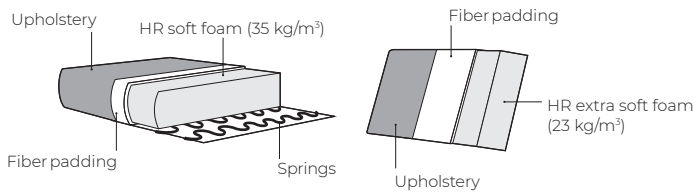

1. Upholstery



2. Armrests



Skagen

W 14 x D 83 x H 53

Athen

W 15 x D 83 x H 53

Cara

W 17 x D 83 x H 53

3. Legs



IMPORTANT:

Upholstered furniture is handmade using soft materials therefore measurements may vary up to **+/- 5 cm**.
Parts and sets shown in 2D drawings are left-sided. Parts and sets can be mirrored from left to right.

Sets (Measurements with Cara armrest)

Scale 1:100

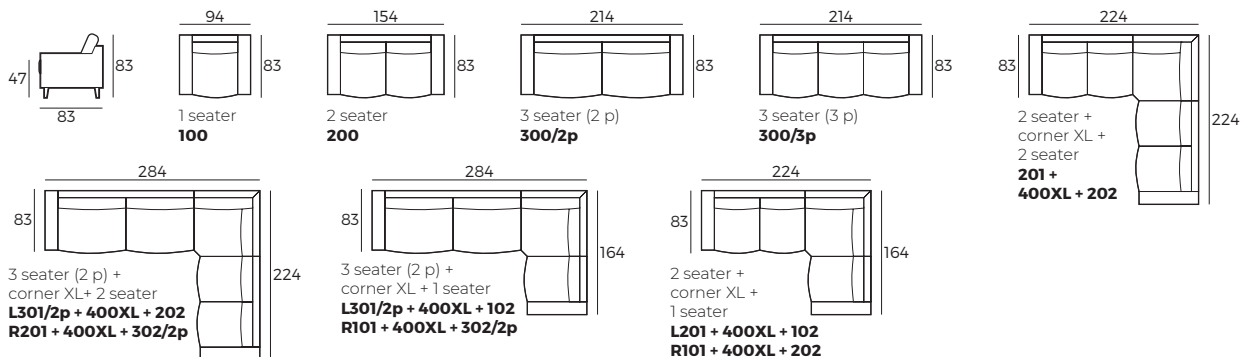

Accessories

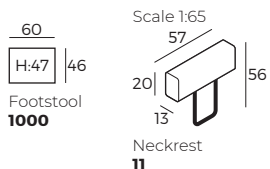

Carolina



Carolina



Comfort

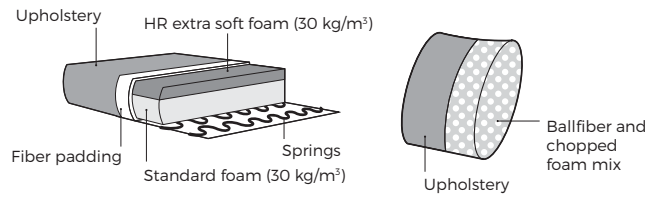

1. Upholstery

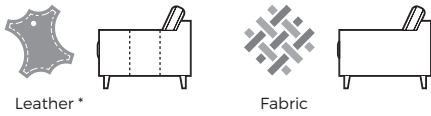

* Leather covers may require more stitches than fabric covers.

2. Armrests

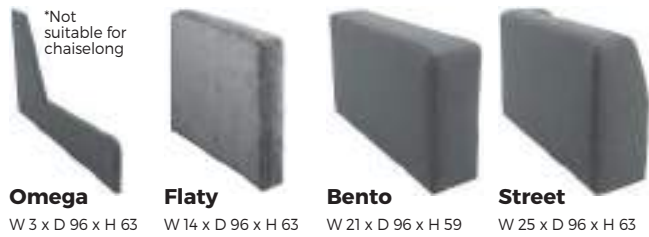

3. Choose pillows



4. Legs



IMPORTANT:

Upholstered furniture is handmade using soft materials therefore measurements may vary up to +/- 5 cm.
Parts and sets shown in 2D drawings are left-sided. Parts and sets can be mirrored from left to right.

Single parts (Measurements with Street armrest)

Scale 1:100

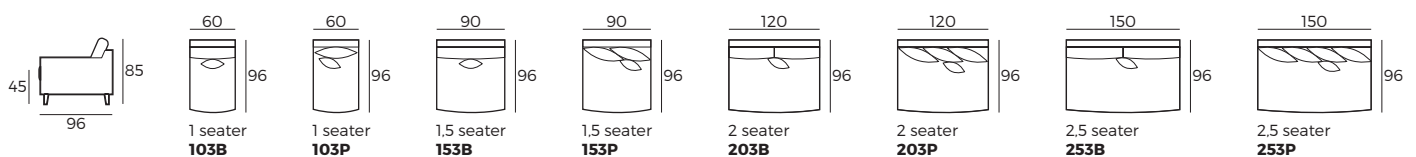

CUSTOM MADE COMFORT

Carolina

Single parts (Measurements with Street armrest)

Scale 1:100

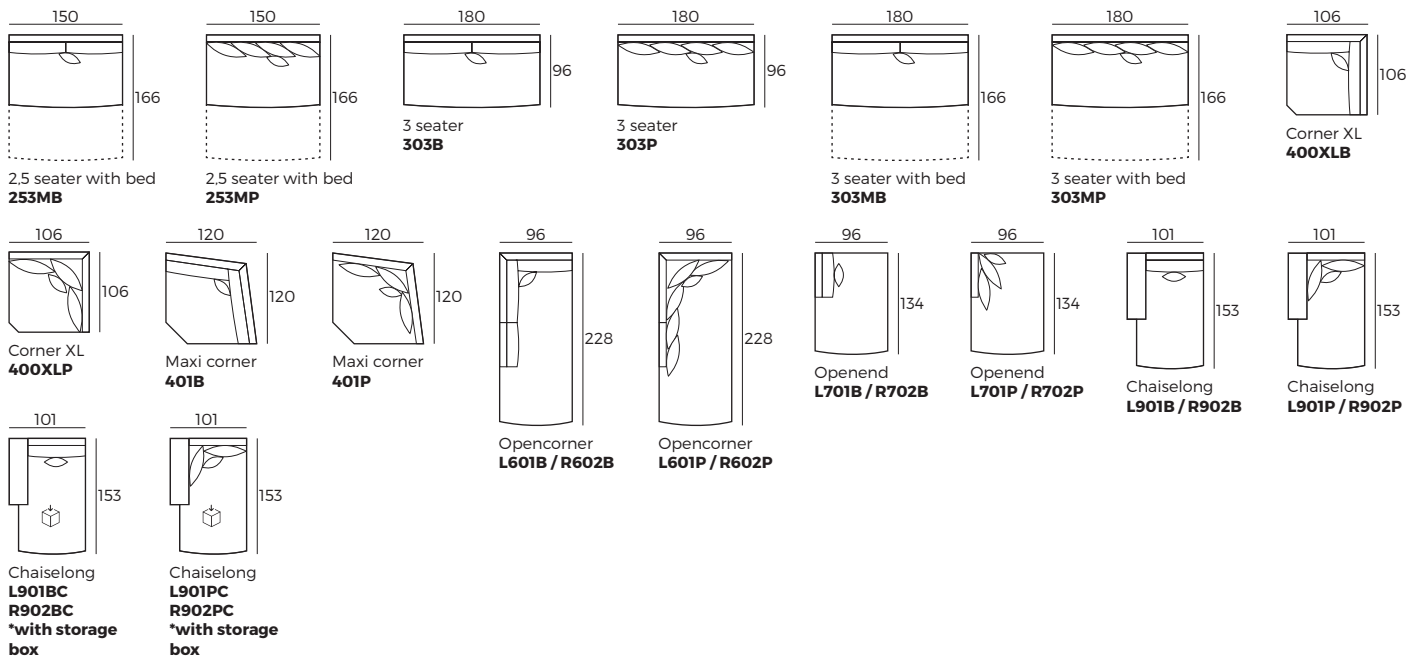

Half sets (Measurements with Street armrest)

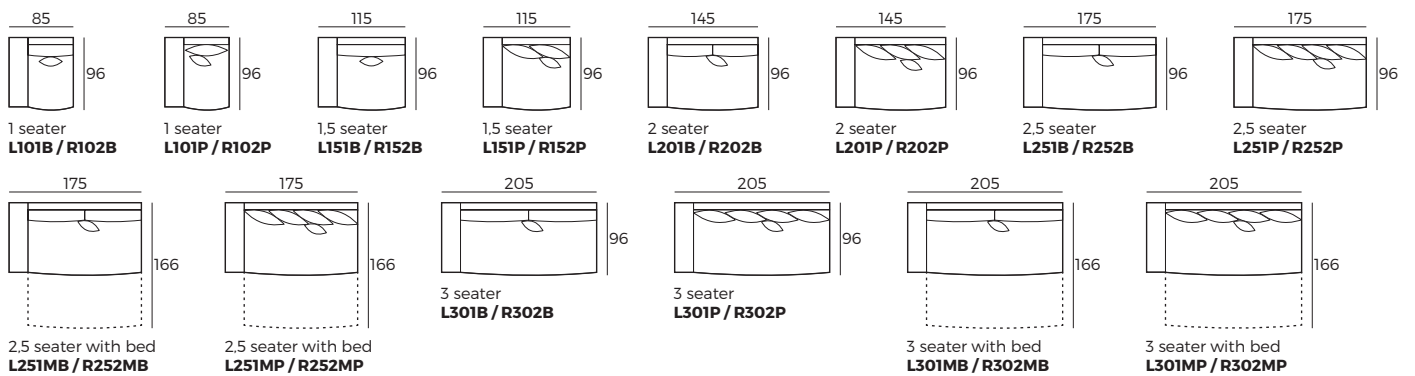

Sets (Measurements with Street armrest)

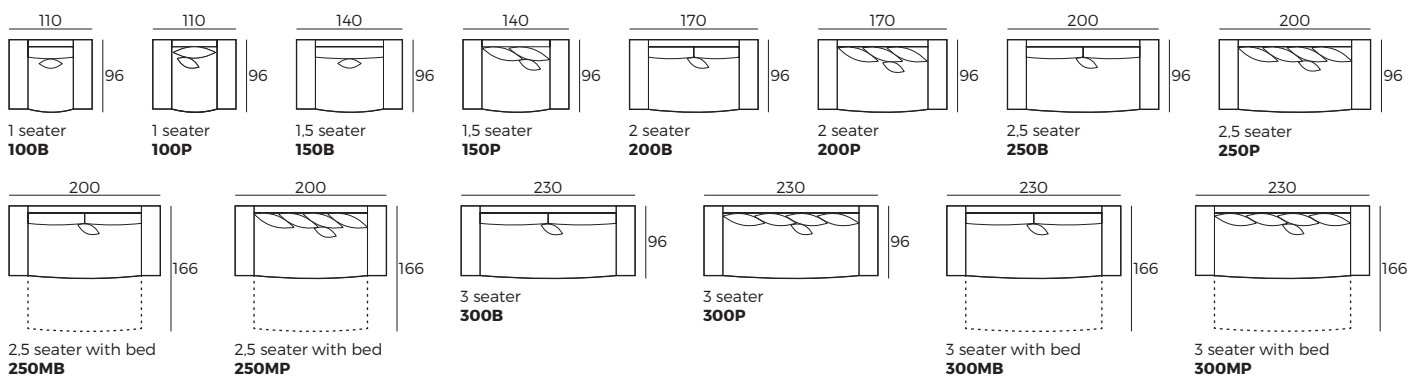

Accessories

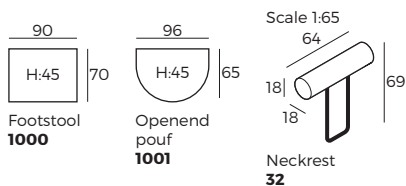

Casper



Casper



Comfort

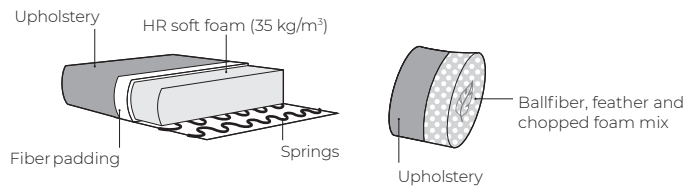

1. Upholstery

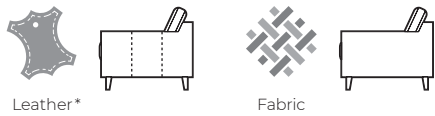

* Leather covers may require more stitches than fabric covers.

2. Legs



IMPORTANT:

Upholstered furniture is handmade using soft materials therefore measurements may vary up to +/- 5 cm.
Parts and sets shown in 2D drawings are left-sided. Parts and sets can be mirrored from left to right.

Single parts

Scale 1:100

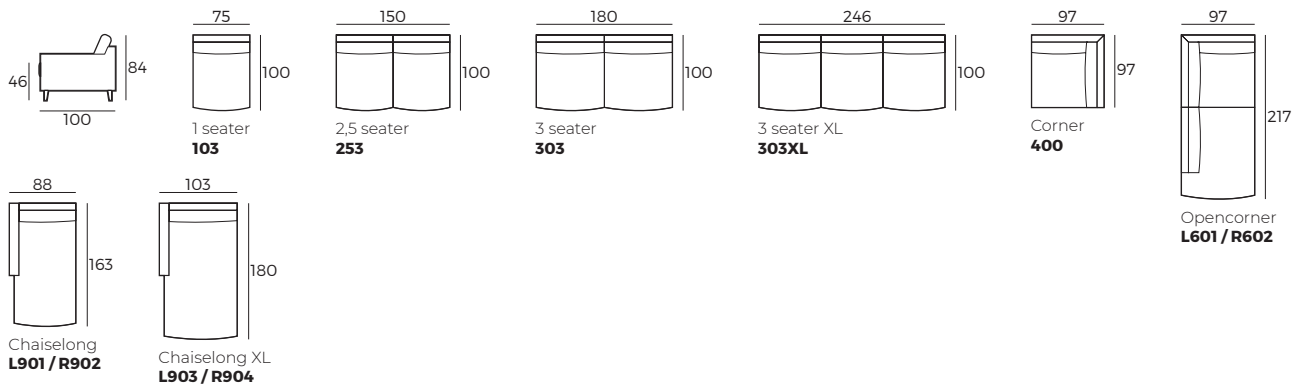

Casper

Scale 1:100

Half sets

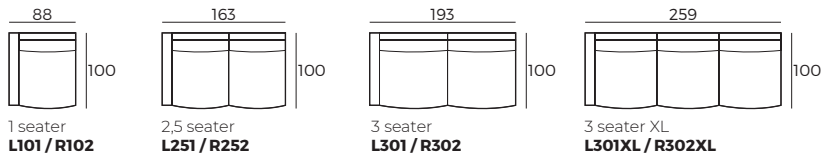

Sets

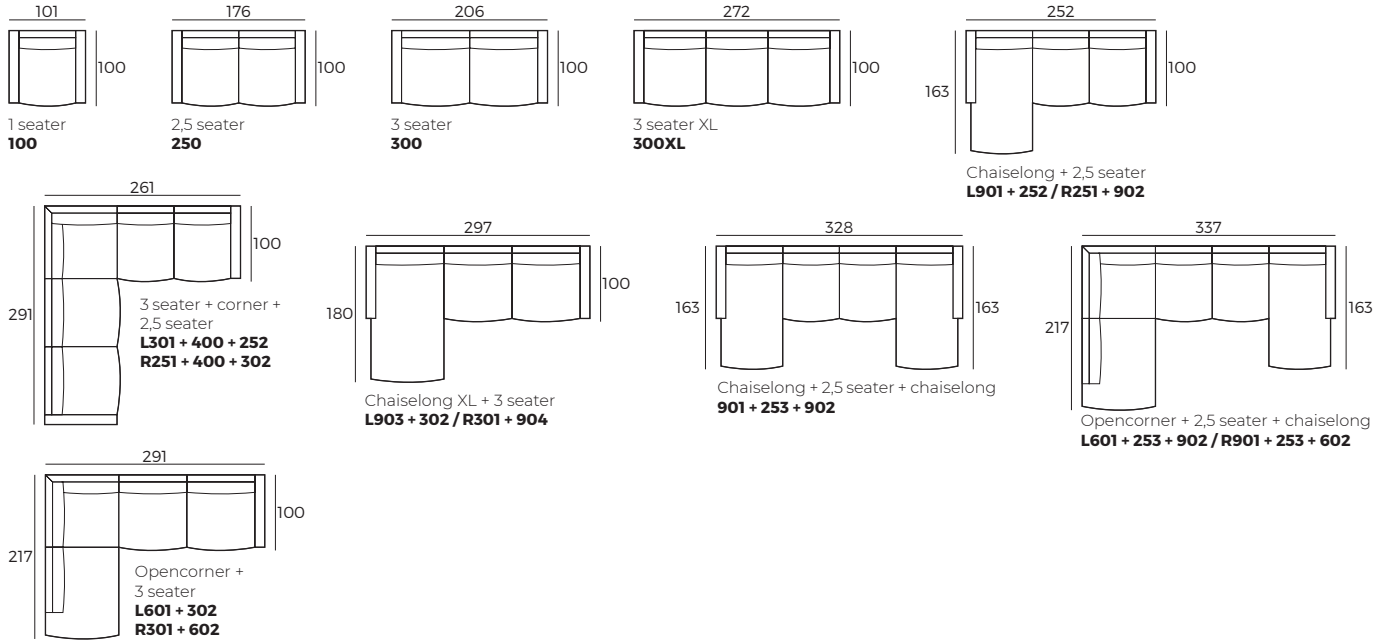

Accessories

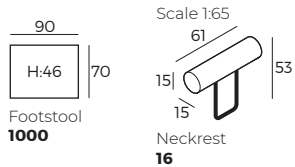

Chilla / Snow



Chilla / Snow



Comfort

CHILLA

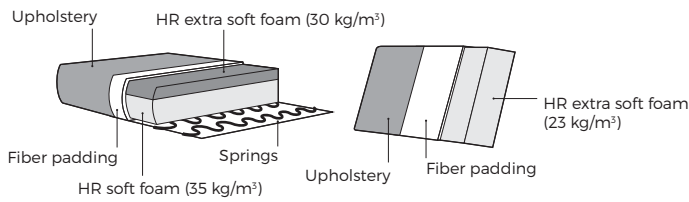

SNOW

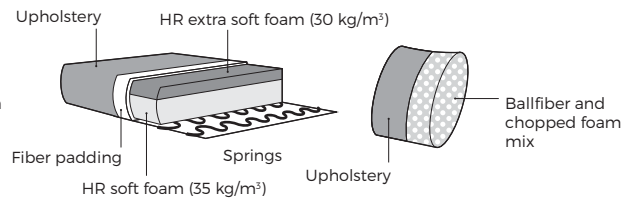

1. Upholstery



Leather*



Fabric



* Leather covers may require more stitches than fabric covers.

2. Legs



191 Oiled



230 Oiled



Black colored lacquer

IMPORTANT:

Upholstered furniture is handmade using soft materials therefore measurements may vary up to +/- 5 cm.

Measurements

Scale 1:35

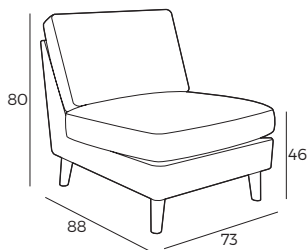

Chilla
100

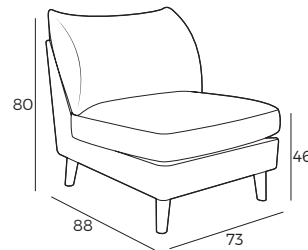

Snow
100

Comfort program



Comfort program



Comfort

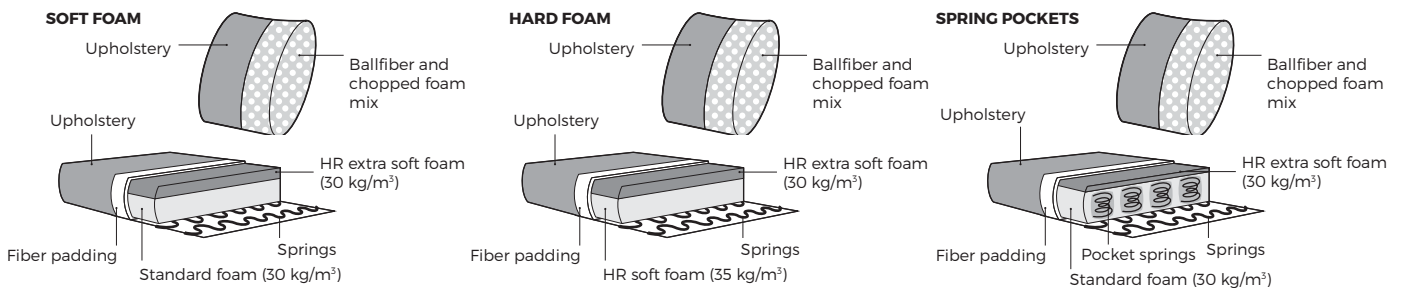

1. Upholstery

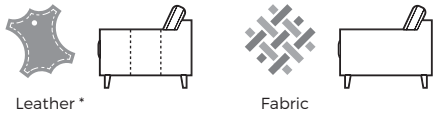

* Leather covers may require more stitches than fabric covers.

2. Headrest & seat type

*Measures with fully opened mechanism

- 1 Manual ↻
- 2 Electrical ⏻

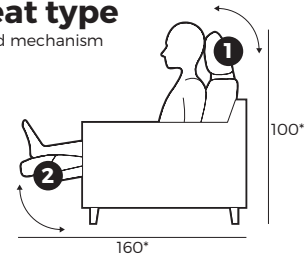

3. Armrests



4. Multicolor option



5. Legs

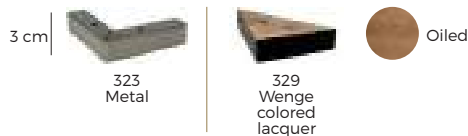

Comfort program

IMPORTANT:

Upholstered furniture is handmade using soft materials therefore measurements may vary up to +/- 5 cm.
Parts and sets shown in 2D drawings are left-sided. Parts and sets can be mirrored from left to right.

Single parts (Measurements with 5 armrest)

Scale 1:100

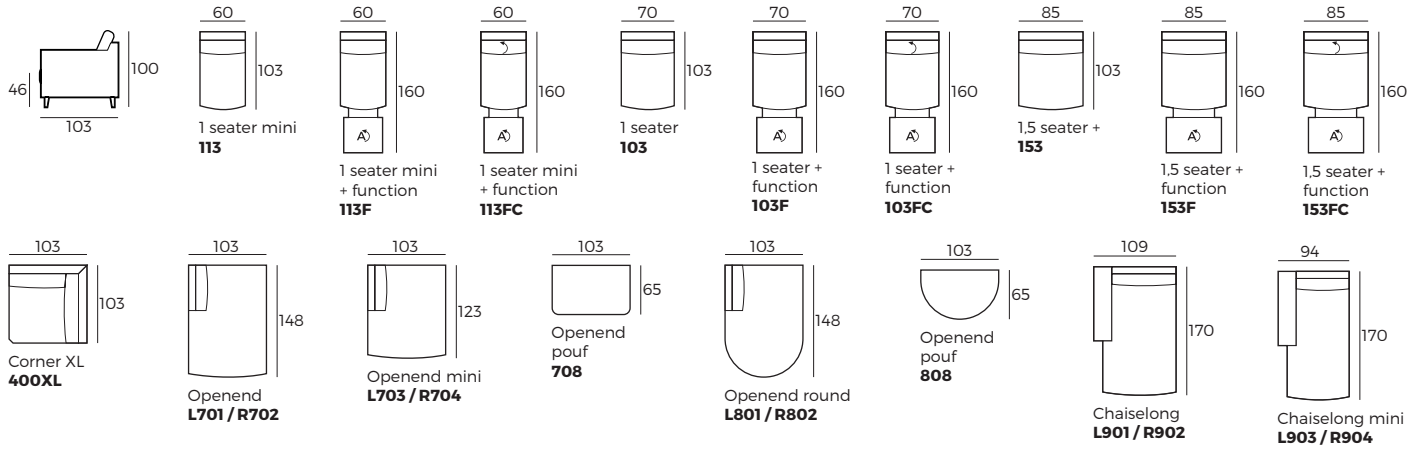

Half sets (Measurements with 5 armrest)

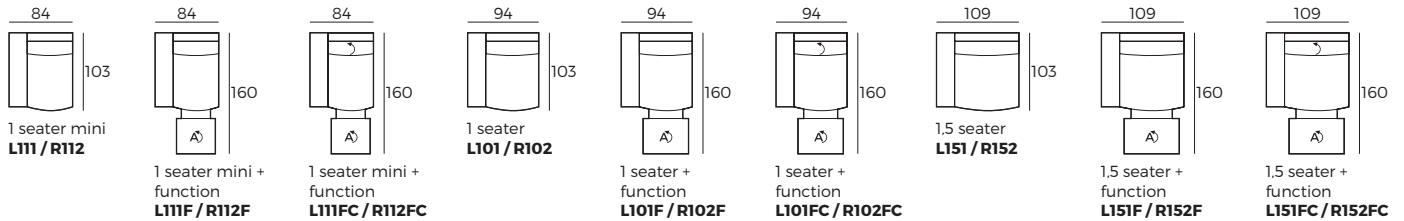

Sets (Measurements with 5 armrest)

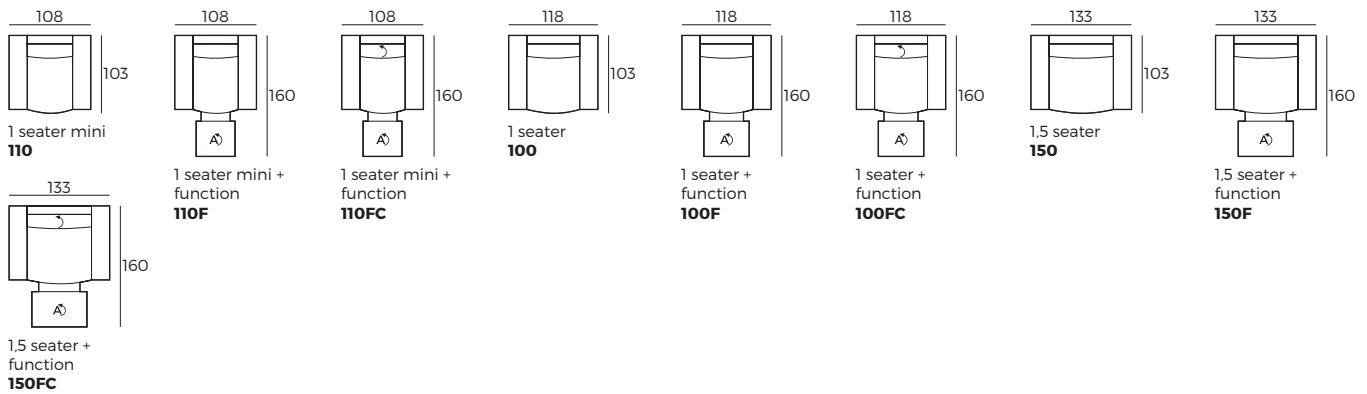

⌋ - manual; Ⓐ - electrical; *F - single electric function; *FC - double electric function

Comfort program

Fixed combinations with A & B back comfort



Without headrest mechanism



Sidney
With armrest no. 1



Orlando
With armrest no. 2

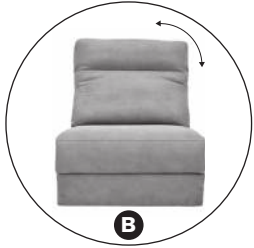

Manual headrest mechanism



Riga
With armrest no. 3



Bally
With armrest no. 4



Oslo
With armrest no. 5



Baku
With armrest no. 6



Kingston
With armrest no. 7

Fixed combinations with C & D back comfort



Without headrest mechanism



Berne
With armrest no. 1



Zurich
With armrest no. 2



Manual headrest mechanism



Parme
With armrest no. 3



Singapur
With armrest no. 4



Kiev
With armrest no. 5



Erwan
With armrest no. 6



Erwan
With armrest no. 7

Comfort program

Fixed combinations with E back comfort



Without headrest
mechanism



Toulouse
With armrest no. 1

Comfy

Scandinavian



Comfy

Scandinavian



Comfort

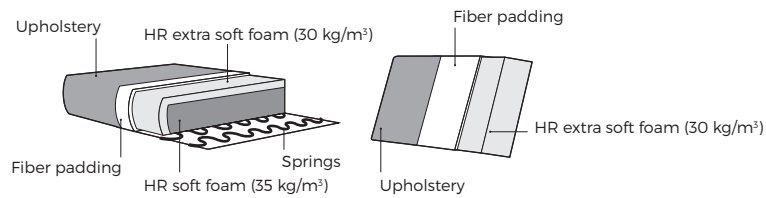

1. Upholstery



2. Legs



IMPORTANT:

Upholstered furniture is handmade using soft materials therefore measurements may vary up to +/- 5 cm.
Parts and sets shown in 2D drawings are left-sided. Parts and sets can be mirrored from left to right.

Single parts

Scale 1:100

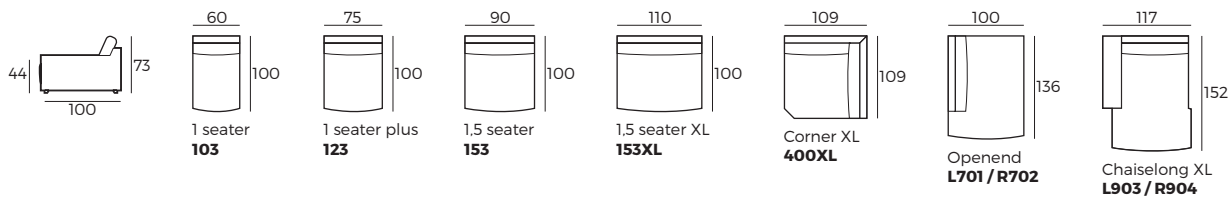

Half sets

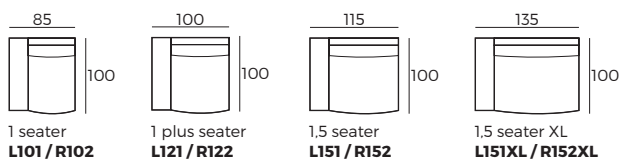

Comfy

Scandinavian

Sets

Scale 1:100

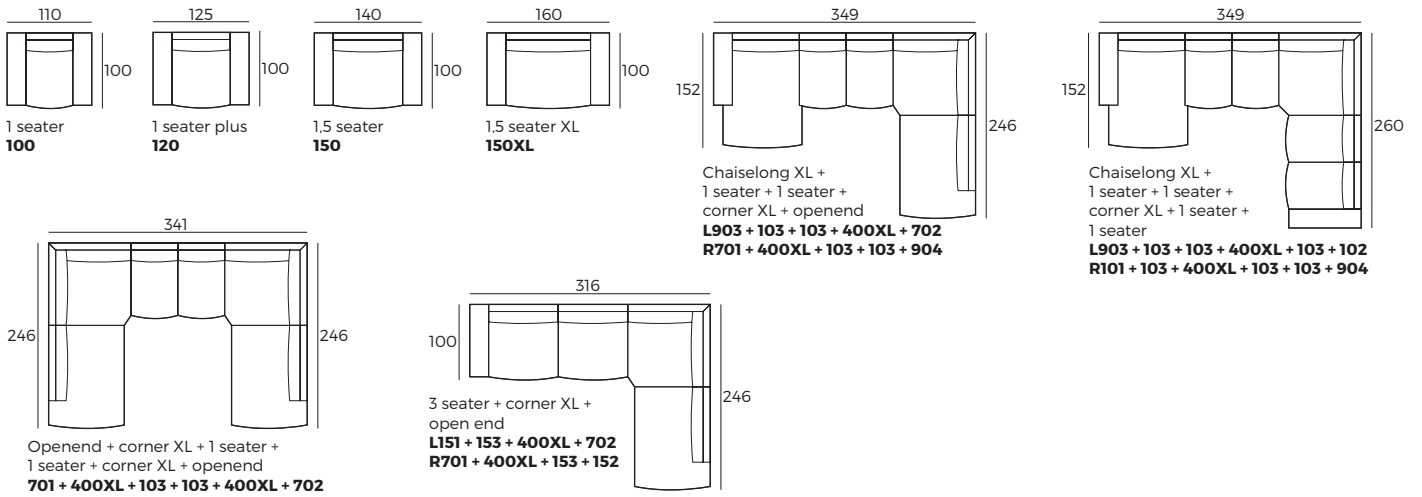

Accessories

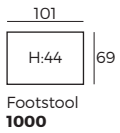

Daisy



Daisy



Comfort

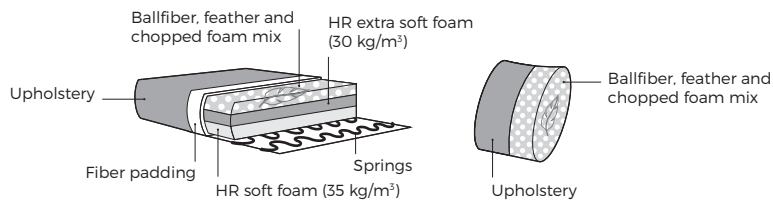

1. Upholstery



Fabric

2. Legs



IMPORTANT:

Upholstered furniture is handmade using soft materials therefore measurements may vary up to +/- 5 cm.
Parts and sets shown in 2D drawings are left-sided. Parts and sets can be mirrored from left to right.

Single parts

Scale 1:100

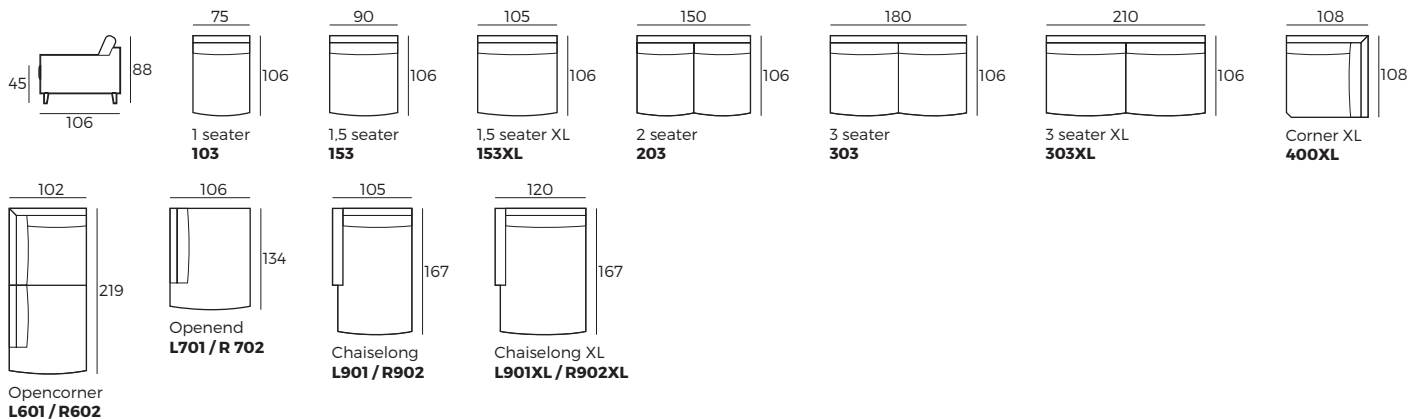

Daisy

Half sets

Scale 1:100

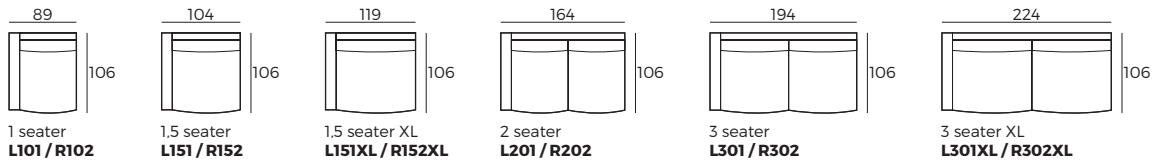

Sets

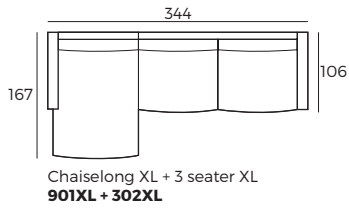
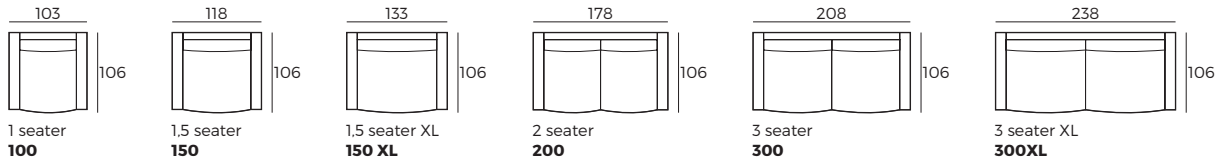

Accessories

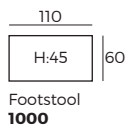

Dealan



Dealan



Comfort

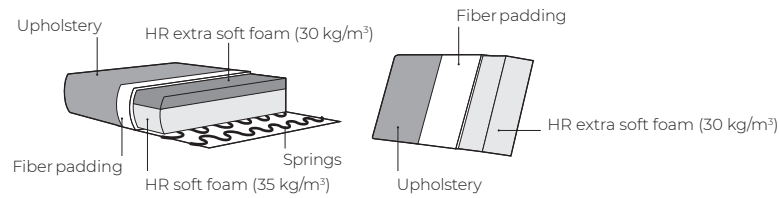

1. Upholstery



* Leather covers may require more stitches than fabric covers.

2. Headrest & seat type

*Measures with fully opened mechanism

- 1 Manual ↷
- 2 Electrical ⤴

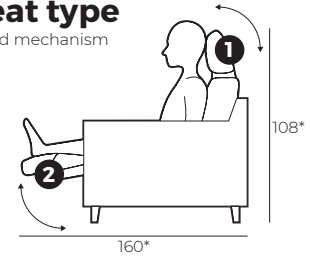

3. Legs



IMPORTANT:

Upholstered furniture is handmade using soft materials therefore measurements may vary up to +/- 5 cm.
Parts and sets shown in 2D drawings are left-sided. Parts and sets can be mirrored from left to right.

Single parts

Scale 1:100

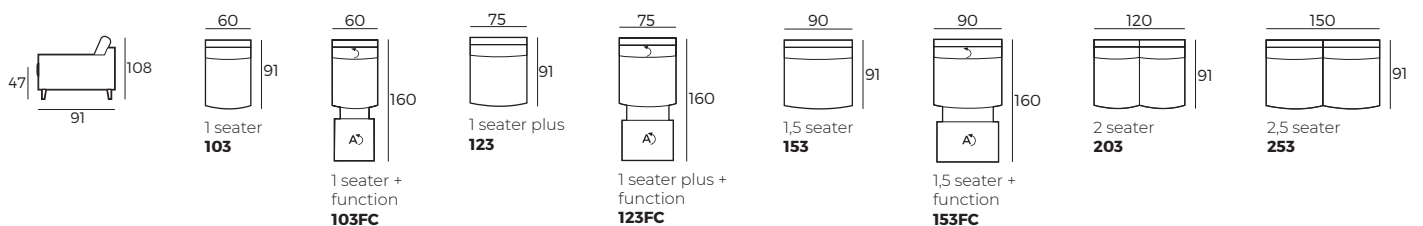

CUSTOM MADE COMFORT

Dealan

Scale 1:100

Single parts

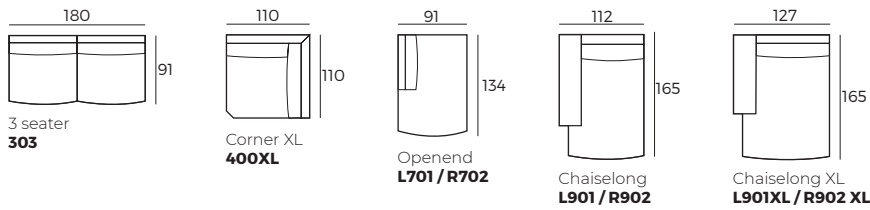

Half sets

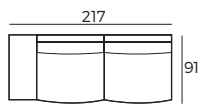
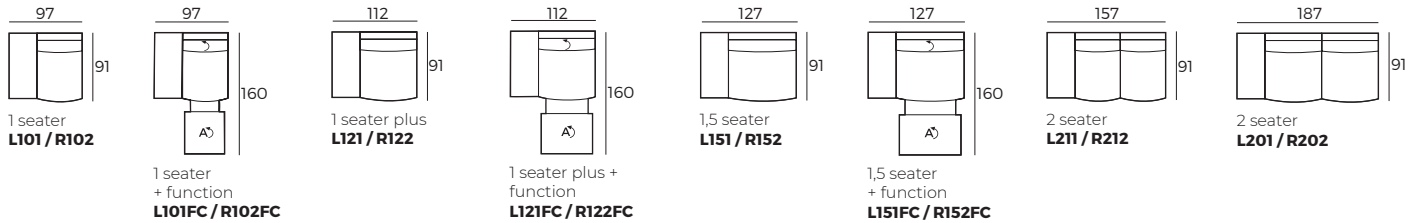

3 seater
L301 / R302

Sets

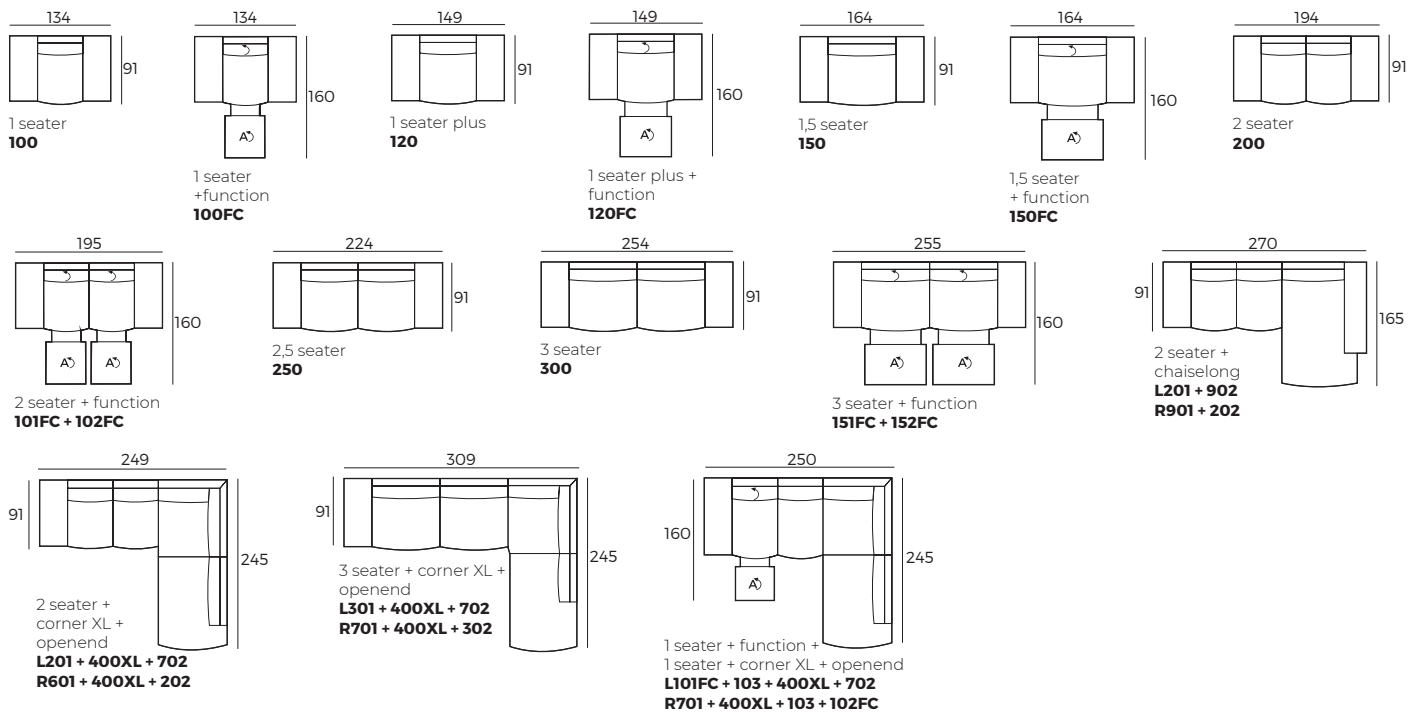

Accessories

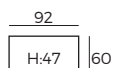

Footstool
1000

↷ - manual; ↻ - electrical *F - single electric function

Decadence



Decadence



Comfort

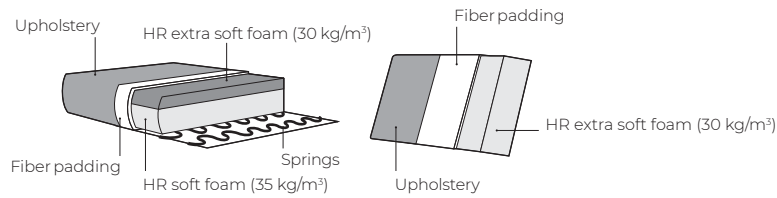

1. Upholstery



* Leather covers may require more stitches than fabric covers.

2. Headrest & seat type

*Measures with fully opened mechanism

- 1 Manual ↷ / Electrical ⚡
- 2 Electrical ⚡

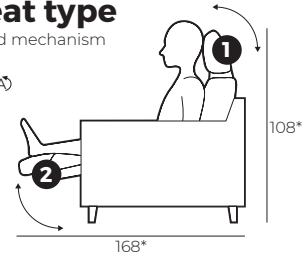

3. Bi-Color option

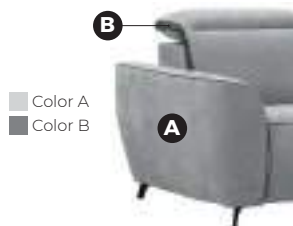

4. Legs



IMPORTANT:

Upholstered furniture is handmade using soft materials therefore measurements may vary up to +/- 5 cm.
Parts and sets shown in 2D drawings are left-sided. Parts and sets can be mirrored from left to right.

Single parts

Scale 1:100

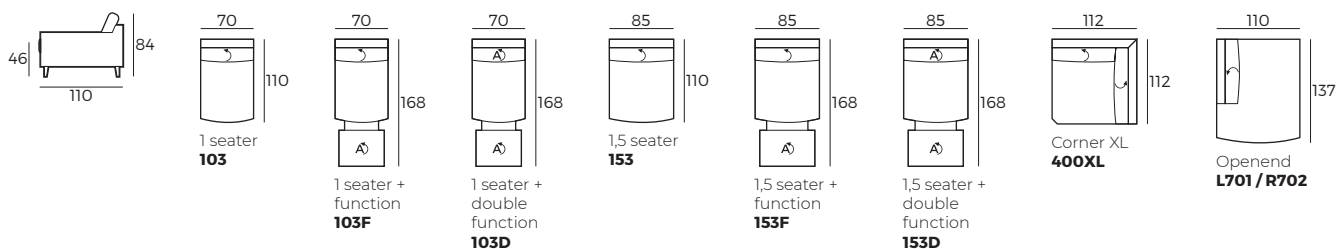

CUSTOM MADE COMFORT

Decadance

Scale 1:100

Single parts

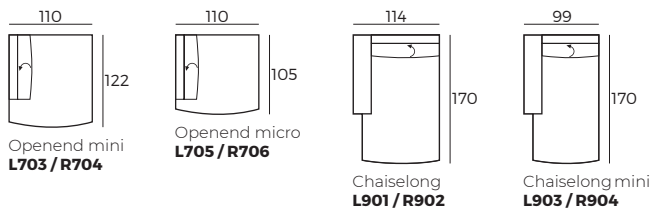

Half sets

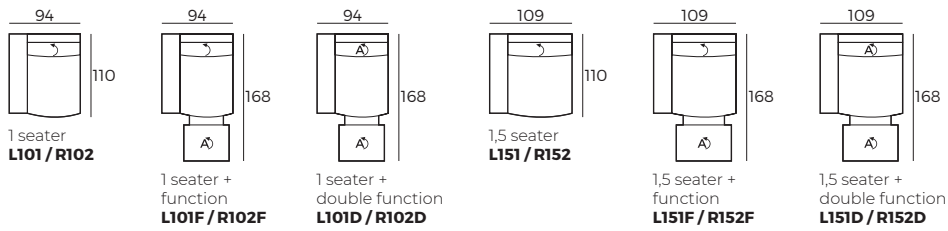

Sets

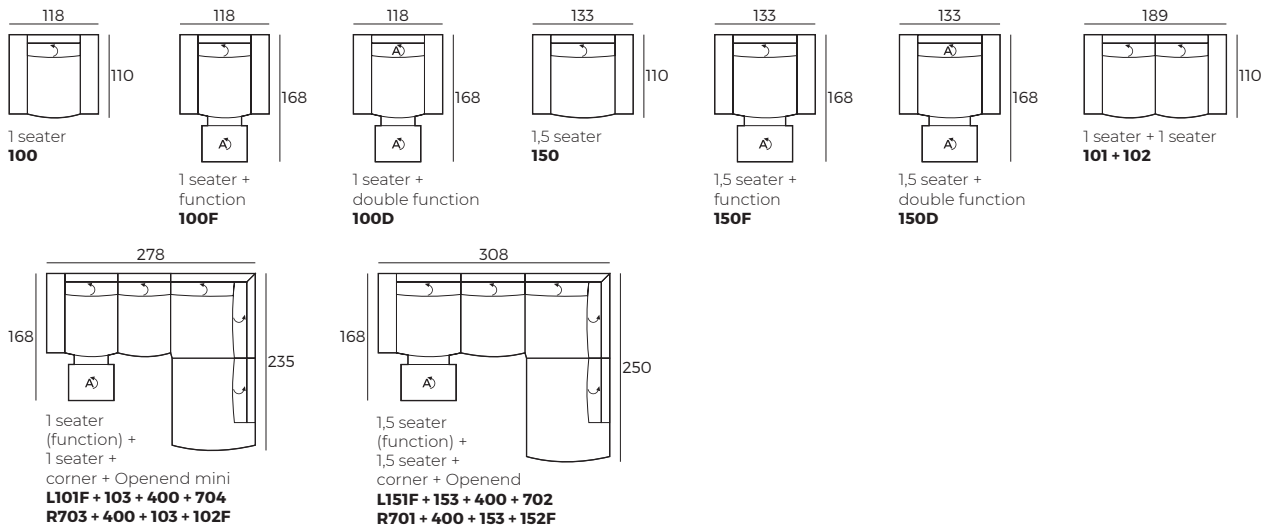

Accessories

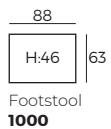

↷ - manual; ↻ - electrical *F - single electric function; *D - double electric function

Dreamer



Dreamer



Comfort

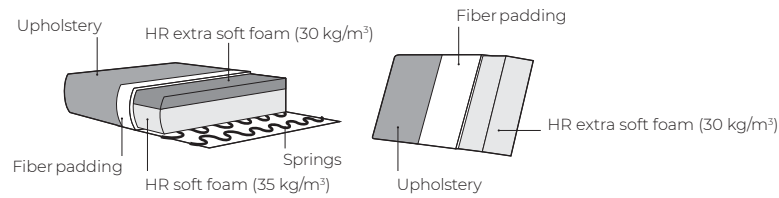

1. Upholstery



* Leather covers may require more stitches than fabric covers.

2. Headrest & seat type

*Measures with fully opened mechanism

- 1 Manual ↶ / Electrical ⌂
- 2 Electrical ⌂

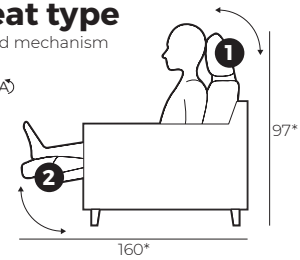

3. Armrests



Omega* W 3 x D 104 x H 55
River W 18 x D 104 x H 55
Gaby W 25 x D 104 x H 55

4. Multicolor option



5. Legs



IMPORTANT:

Upholstered furniture is handmade using soft materials therefore measurements may vary up to +/- 5 cm.
 Parts and sets shown in 2D drawings are left-sided. Parts and sets can be mirrored from left to right.

Single parts (Measurements with Gaby armrest)

Scale 1:100

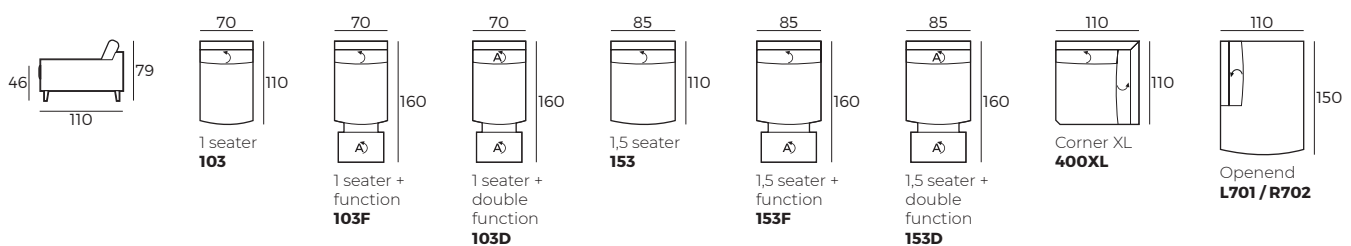

CUSTOM MADE COMFORT

Dreamer

Single parts (Measurements with Gaby armrest)

Scale 1:100

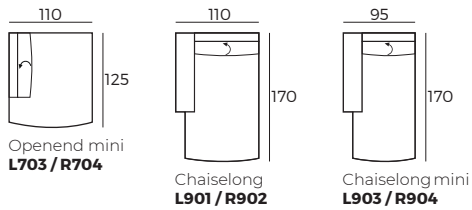

Half sets (Measurements with Gaby armrest)

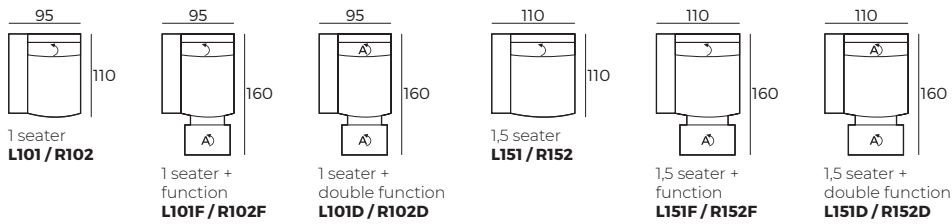

Sets (Measurements with Gaby armrest)

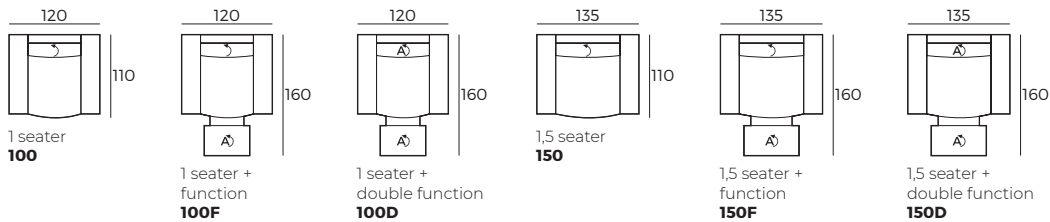

Accessories

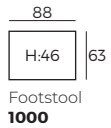

› - manual; Ⓐ - electrical *F - single electric function; *D - double electric function

Eden



Eden



Comfort

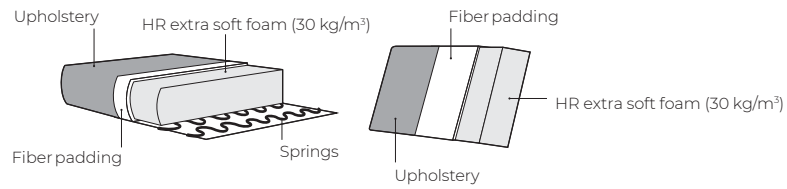

1. Upholstery



Fabric

2. Legs



IMPORTANT:

Upholstered furniture is handmade using soft materials therefore measurements may vary up to **+/- 5 cm**.
Parts and sets shown in 2D drawings are left-sided. Parts and sets can be mirrored from left to right.

Measurements

Scale 1:100

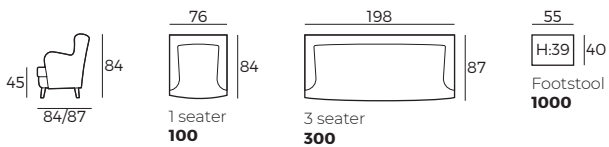

Edouart



Edouart



Comfort

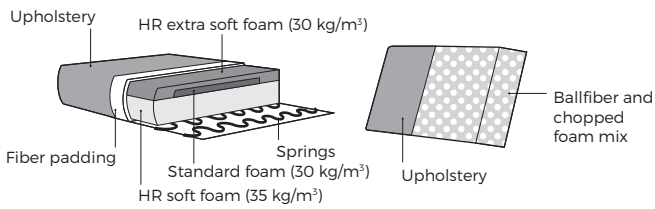

1. Upholstery



* Leather covers may require more stitches than fabric covers.

2. Armrests



Omega* W 3 x D 96 x H 61
Flaty W 14 x D 96 x H 61
Covy W 19 x D 96 x H 61
Street W 25 x D 96 x H 61

3. Legs



Back cushion neckrest

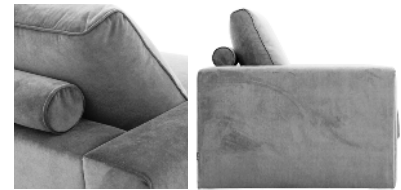

IMPORTANT:

Upholstered furniture is handmade using soft materials therefore measurements may vary up to +/- 5 cm.
 Parts and sets shown in 2D drawings are left-sided. Parts and sets can be mirrored from left to right.

Single parts (Measurements with Covy armrest)

Scale 1:100

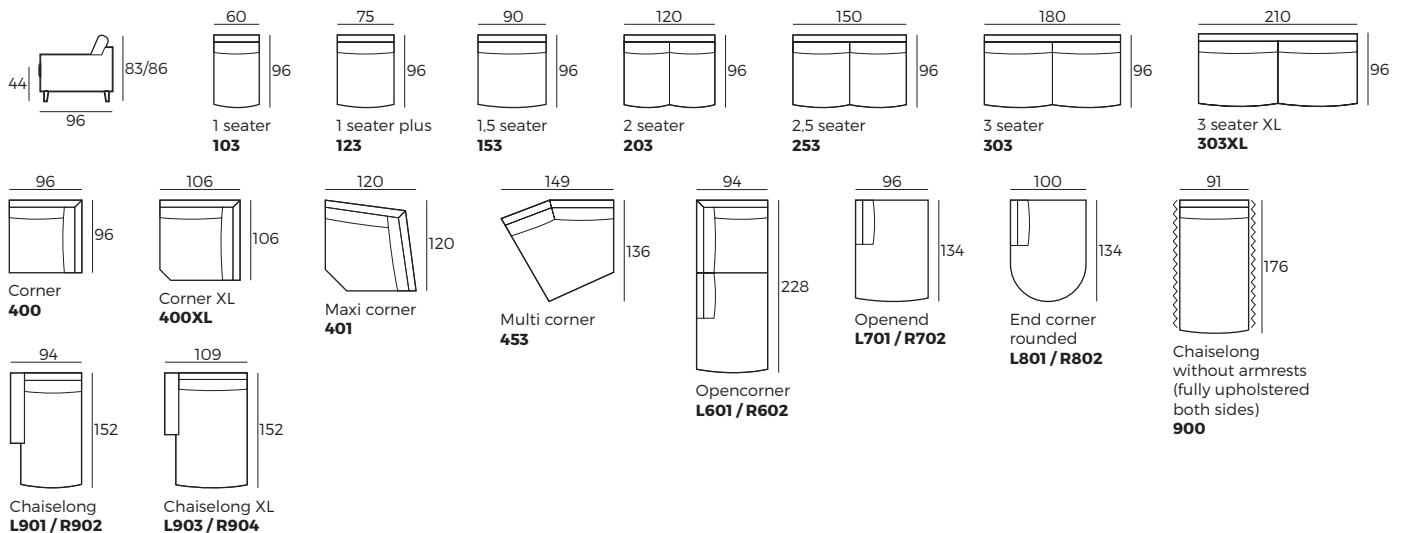

Edouart

Half sets (Measurements with Covy armrest)

Scale 1:100

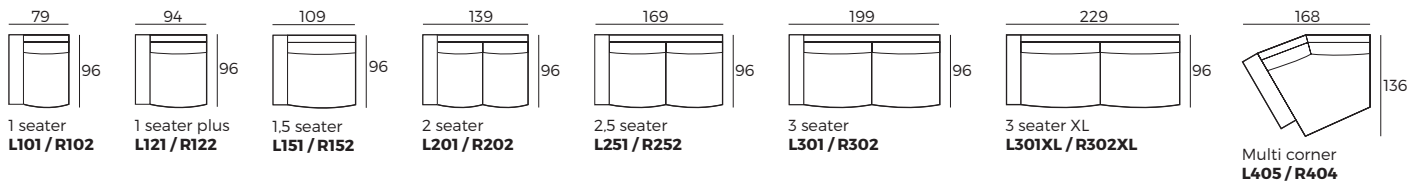

Sets (Measurements with Covy armrest)

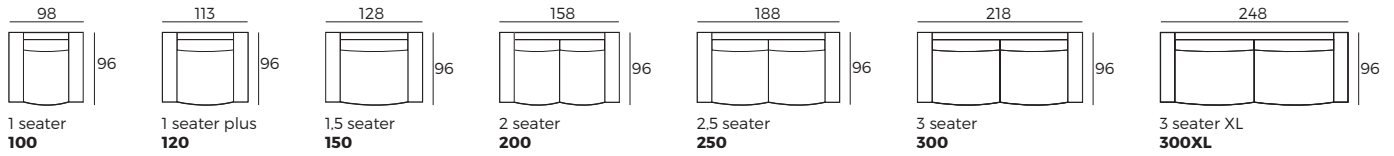

Accessories

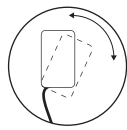
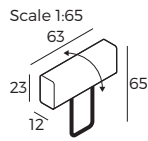
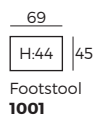
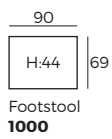

*Only this neckrest is suitable for this furniture.

Elegance



Elegance



Comfort

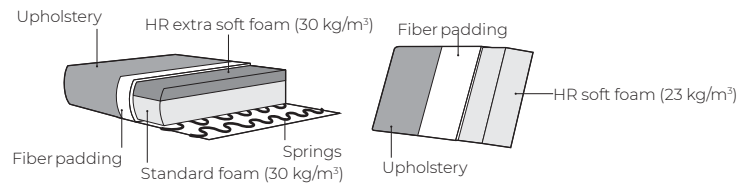

1. Upholstery



*Leather covers may require more stitches than fabric covers.

2. Headrest type

*Measures with fully opened mechanism

1 Manual ↻

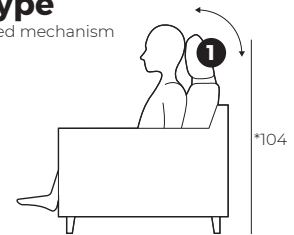

3. Movable back

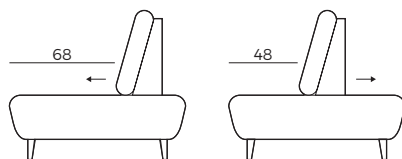

4. Bi-Color option

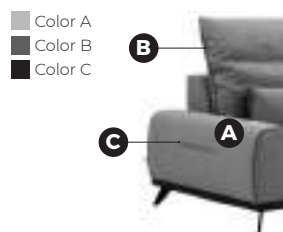

5. Legs



IMPORTANT:

Upholstered furniture is handmade using soft materials therefore measurements may vary up to +/- 5 cm.
Parts and sets shown in 2D drawings are left-sided. Parts and sets can be mirrored from left to right.

Single parts

Scale 1:100

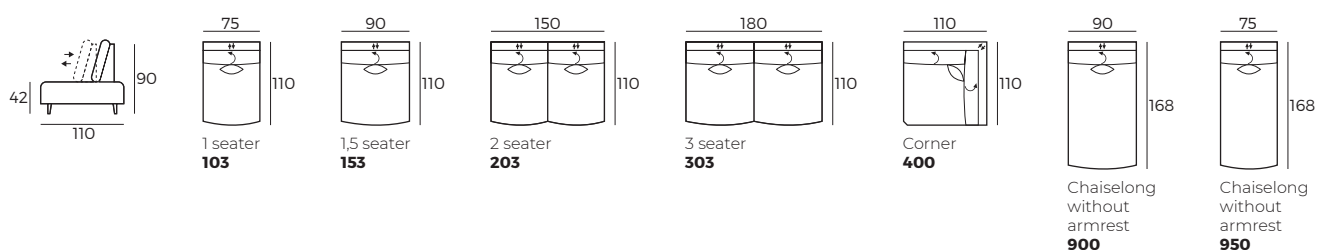

CUSTOM MADE COMFORT

Elegance

Scale 1:100

Single parts

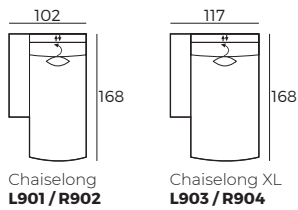

Half sets

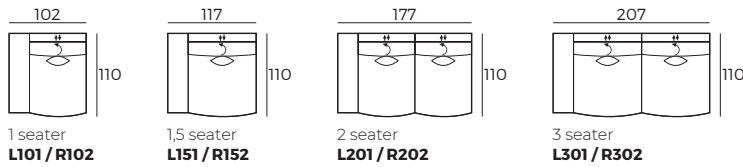

Sets

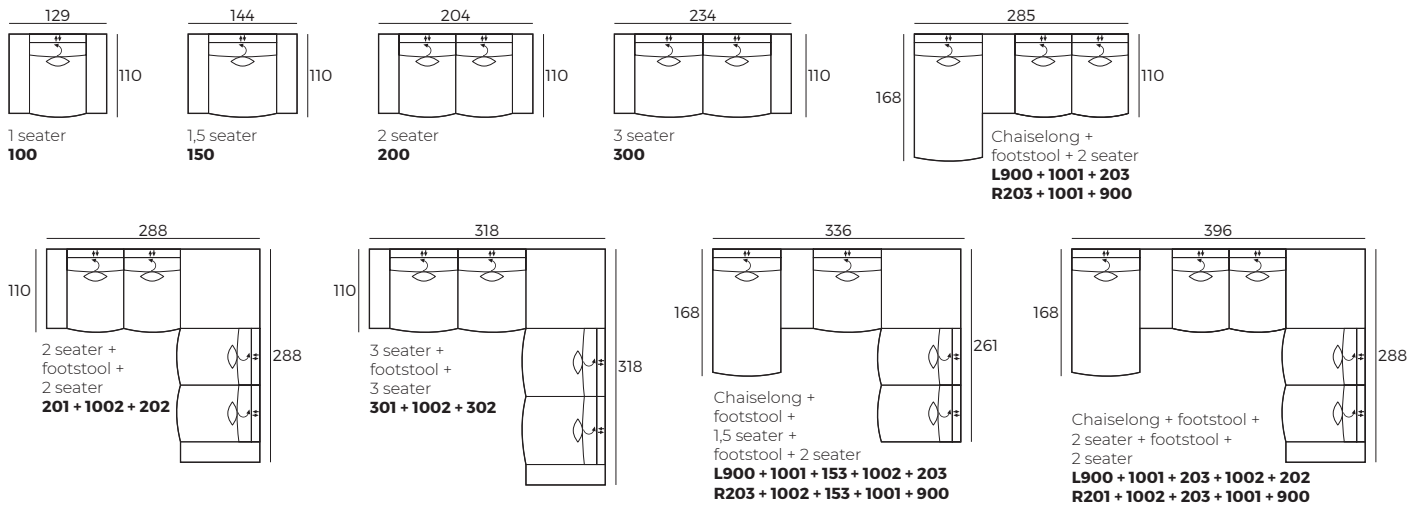

Accessories

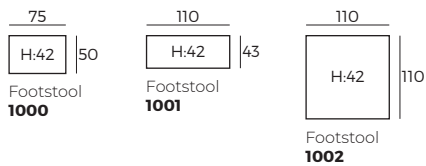

↶ - manual; ↷ - movable back seat depth

Ella



Ella



Comfort

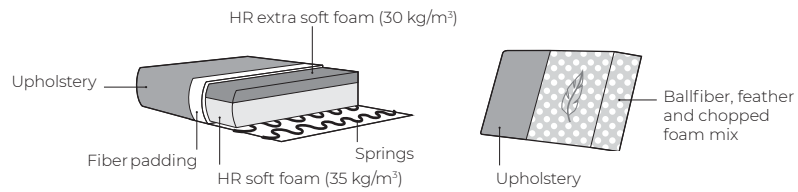

1. Upholstery



* Leather covers may require more stitches than fabric covers.

2. Legs

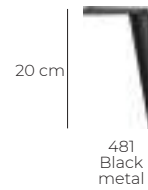

IMPORTANT:

Upholstered furniture is handmade using soft materials therefore measurements may vary up to +/- 5 cm.

Sets

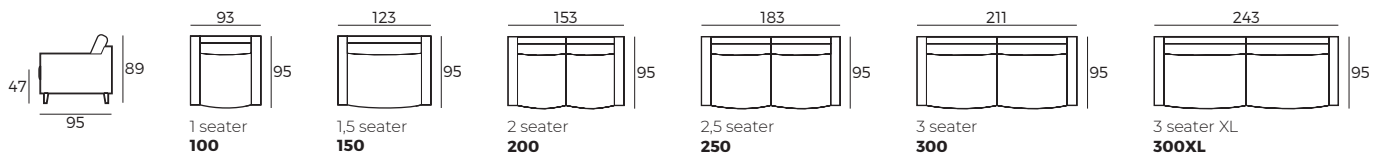

Accessories

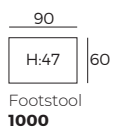

Equinoxe



Equinoxe



Comfort

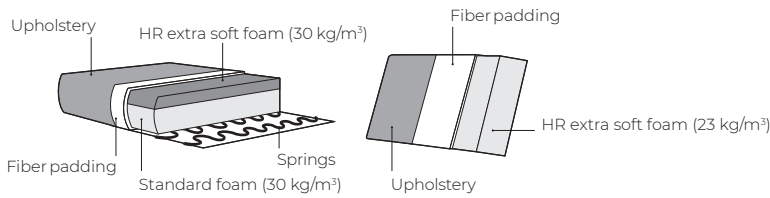

1. Upholstery



2. Headrest & seat type

*Measures with fully opened mechanism

- 1 Manual ↶
- 2 Electrical ⚡

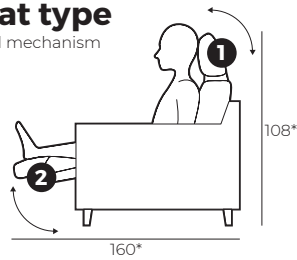

3. Multicolor option



4. Legs



IMPORTANT:

Upholstered furniture is handmade using soft materials therefore measurements may vary up to +/- 5 cm.
Parts and sets shown in 2D drawings are left-sided. Parts and sets can be mirrored from left to right.

Single parts

Scale 1:100

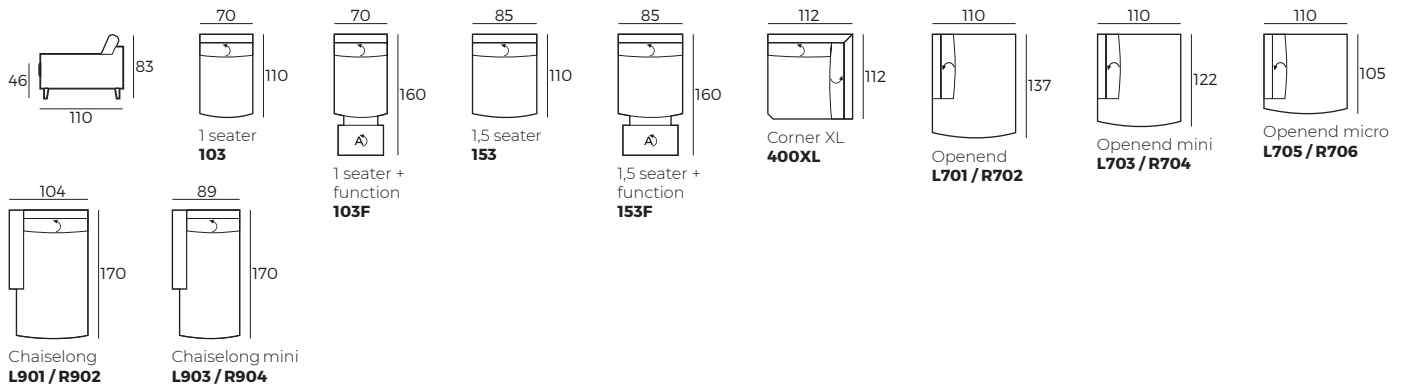

Equinoxe

Scale 1:100

Half sets

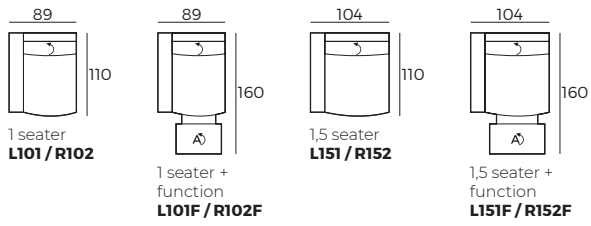

Sets

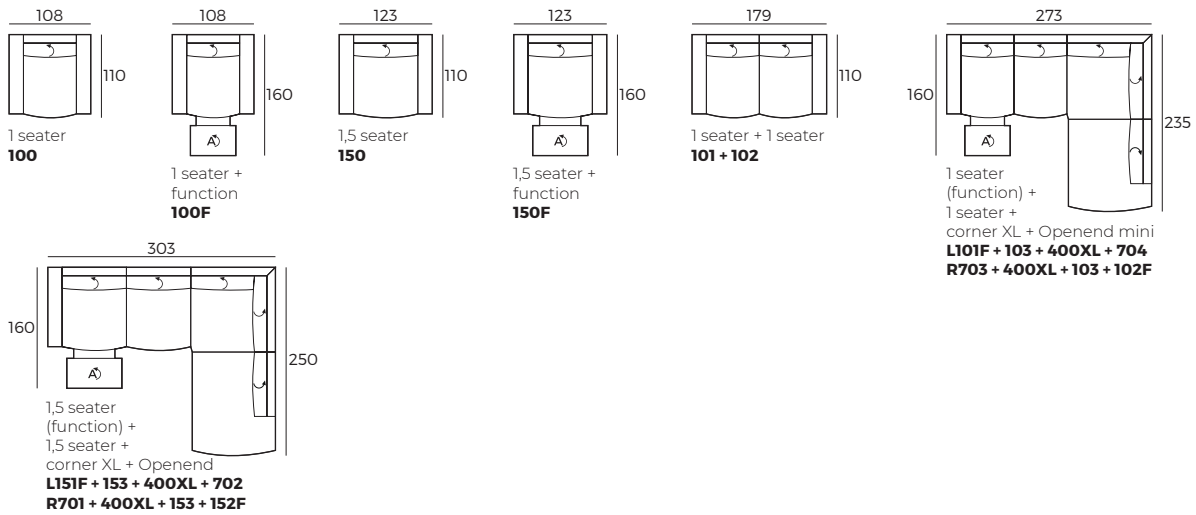

Accessories

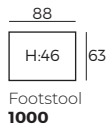

↶ - manual; Ⓐ - electrical *F - single electric function

Etro



Etro



Comfort

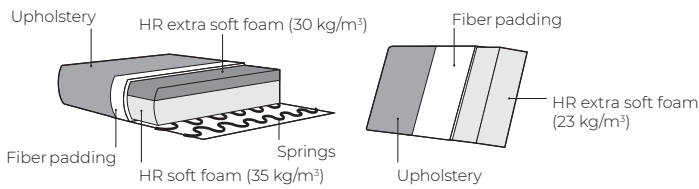

1. Upholstery

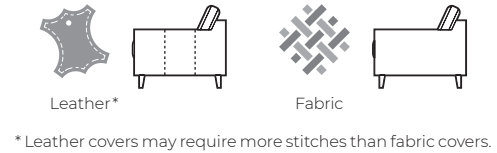

2. Multicolor option

- Color A
- Color B
- Color C

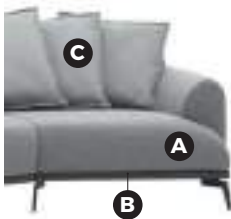

3. Choose pillows

Multi corner



4. Legs



IMPORTANT:

Upholstered furniture is handmade using soft materials therefore measurements may vary up to +/- 5 cm.
Parts and sets shown in 2D drawings are left-sided. Parts and sets can be mirrored from left to right.

Single parts

Scale 1:100

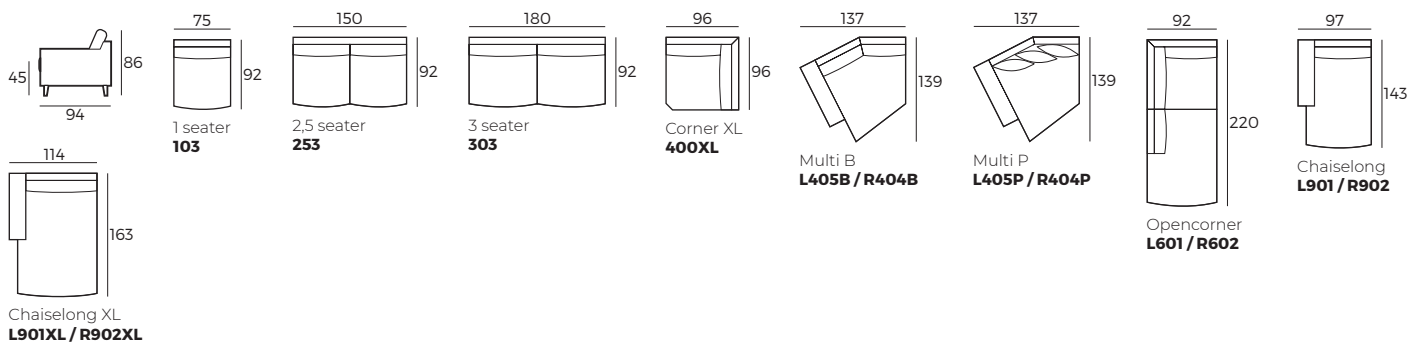

Half sets

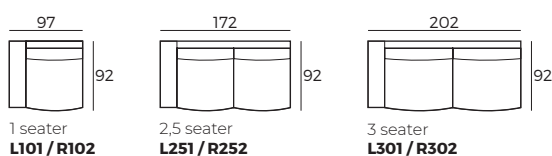

CUSTOM MADE COMFORT

Etro

Sets

Scale 1:100

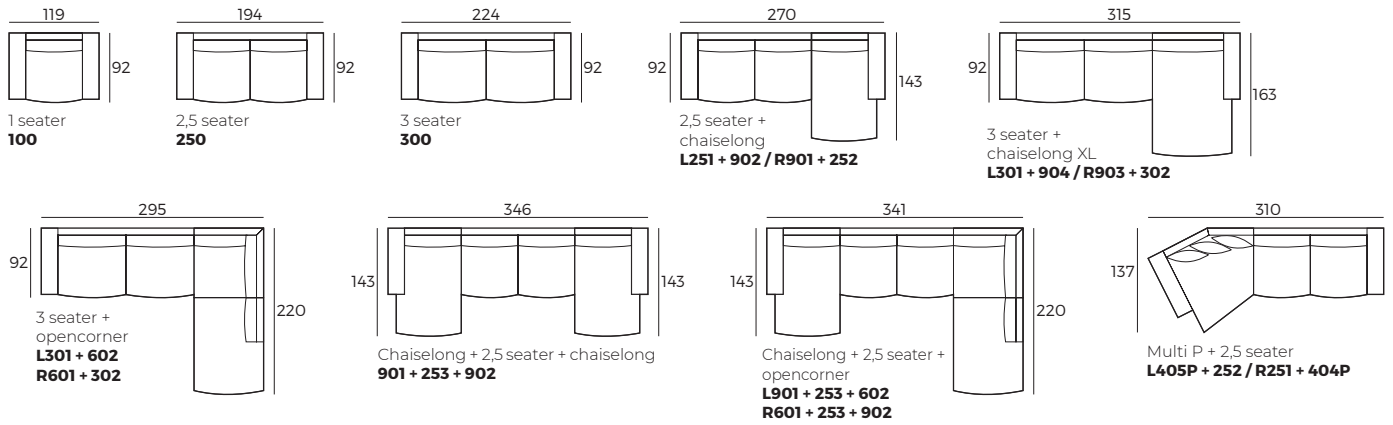

Accessories



Evolution



Evolution



Comfort

1. Upholstery

2. Headrest type

*Measures with fully opened mechanism

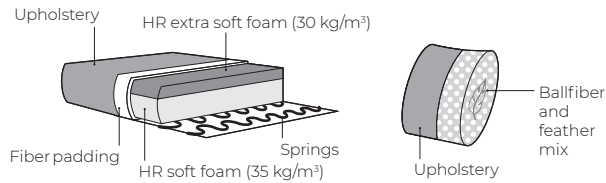

Fabric

1 Manual ↻

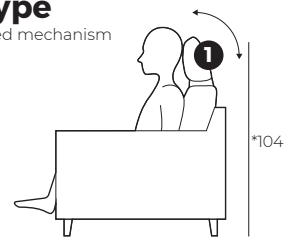

3. Movable back

4. Multicolor option

5. Legs

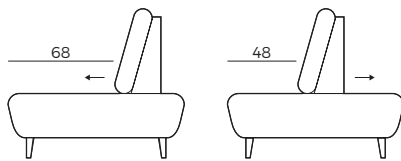

- Color A
- Color B
- Color C

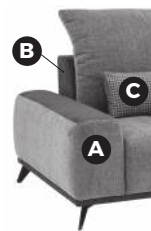

394 Black metal

IMPORTANT:

Upholstered furniture is handmade using soft materials therefore measurements may vary up to **+/- 5 cm**.
Parts and sets shown in 2D drawings are left-sided. Parts and sets can be mirrored from left to right.

Single parts

Scale 1:100

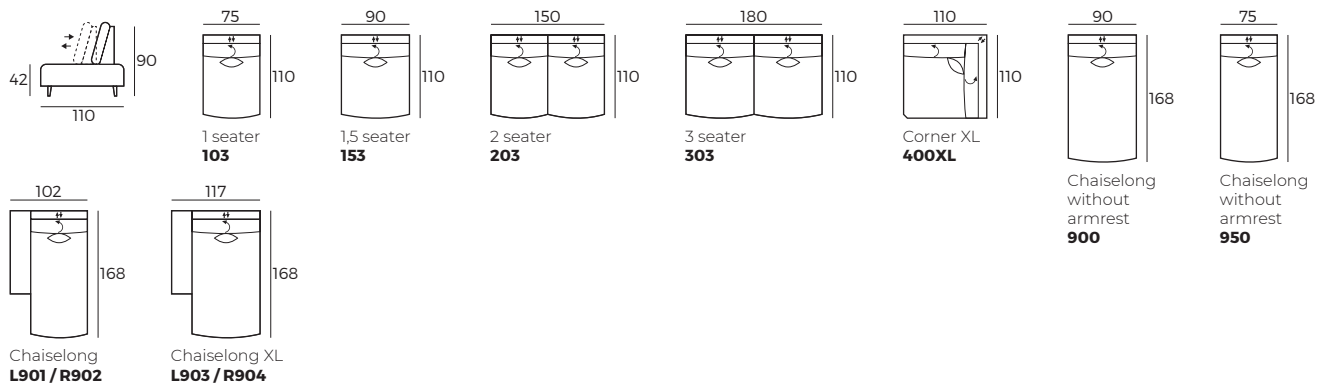

Evolution

Scale 1:100

Half sets

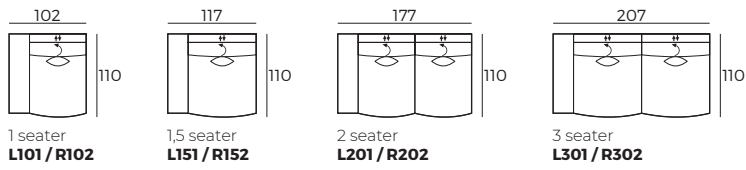

Sets

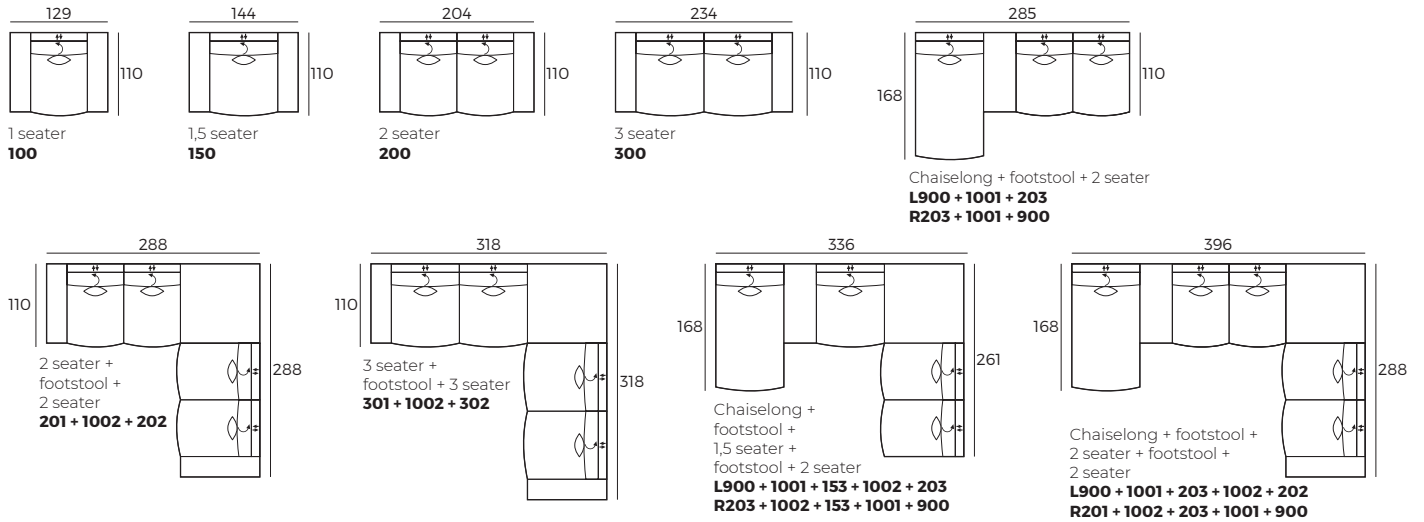

Accessories

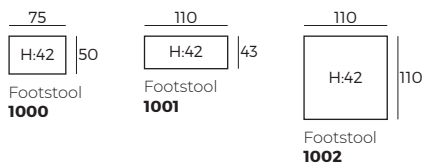

↷ - manual; ↕ - movable back seat depth

Fascination



Fascination



Comfort

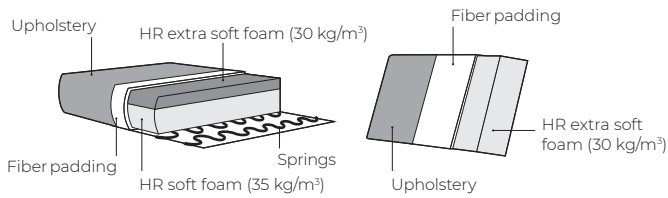

1. Upholstery



* Leather covers may require more stitches than fabric covers.

2. Headrest & seat type

*Measures with fully opened mechanism

- 1 Manual ↷ / Electrical ⤴
- 2 Electrical ⤴

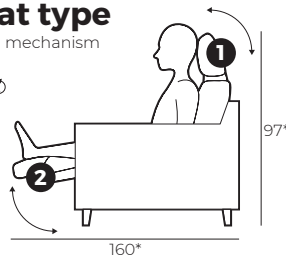

3. Multicolor option



4. Armrests



Omega*

W 3 x L 104 x H 55



River

W 18 x L 104 x H 55



Fascination

W 25 x L 104 x H 55



Gaby

W 25 x L 104 x H 55

5. Legs



IMPORTANT:

Upholstered furniture is handmade using soft materials therefore measurements may vary up to +/- 5 cm.
Parts and sets shown in 2D drawings are left-sided. Parts and sets can be mirrored from left to right.

Single parts (Measurements with Fascination armrest)

Scale 1:100

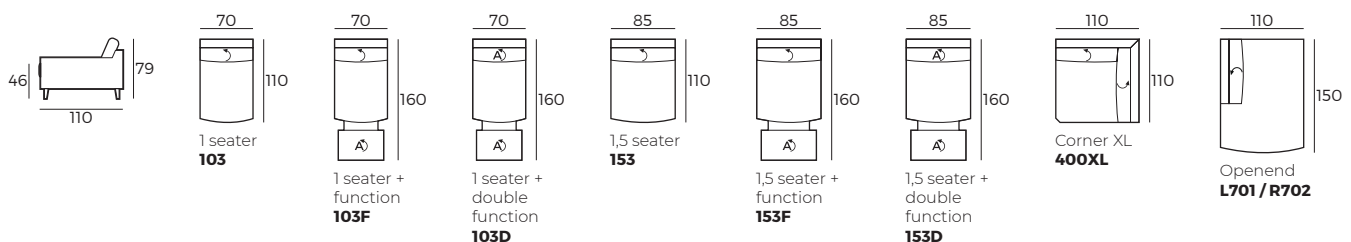

Facination

Single parts (Measurements with Fascination armrest)

Scale 1:100

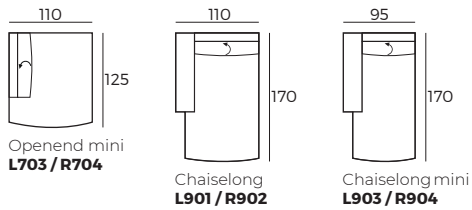

Half sets (Measurements with Fascination armrest)

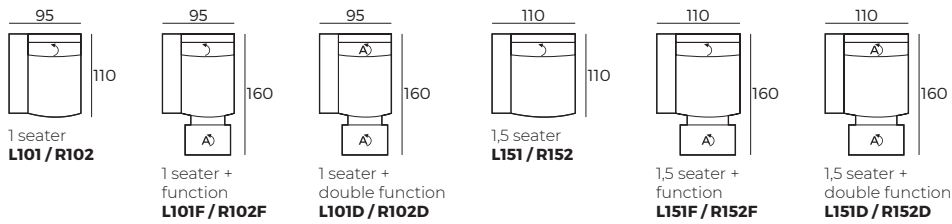

Sets (Measurements with Fascination armrest)

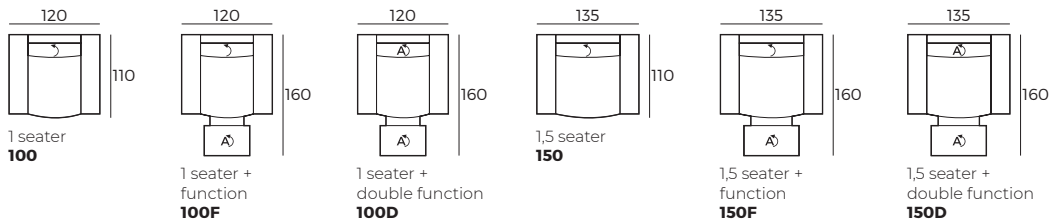

Accessories

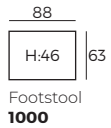

› - manual; Ⓐ - electrical *F - single electric function; *D - double electric function

Felton



Felton



Comfort

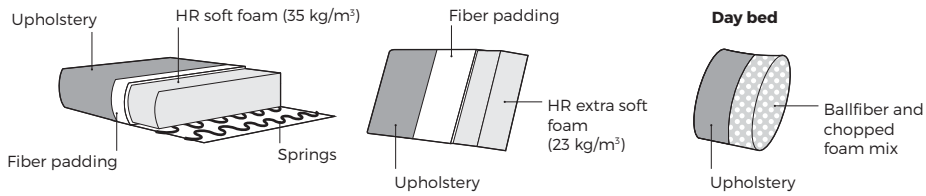

1. Upholstery



2. Legs



IMPORTANT:

Upholstered furniture is handmade using soft materials therefore measurements may vary up to +/- 5 cm.
Parts and sets shown in 2D drawings are left-sided. Parts and sets can be mirrored from left to right.

Sets

Scale 1:100

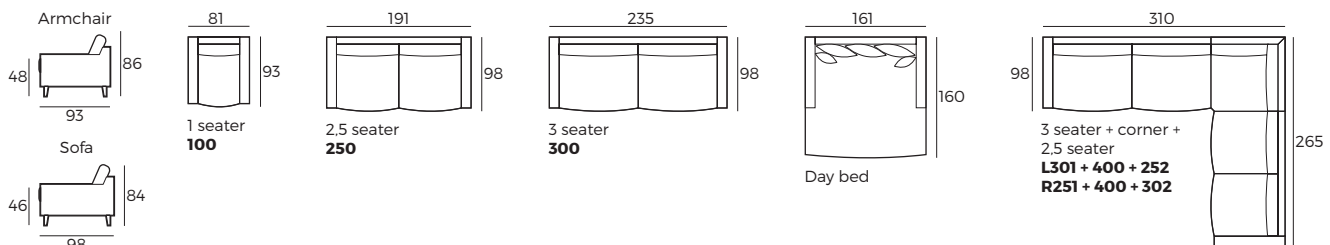

Accessories

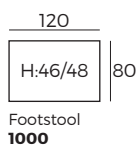
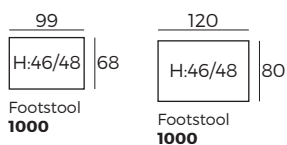

CUSTOM MADE COMFORT

Fifties



Fifties



Comfort

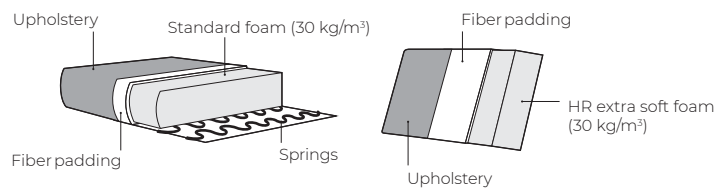

1. Upholstery



Fabric

2. Legs



IMPORTANT:

Upholstered furniture is handmade using soft materials therefore measurements may vary up to **+/- 5 cm**.

Measurements

Scale 1:100

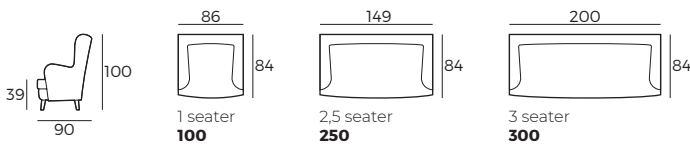

Florida



Florida



Comfort

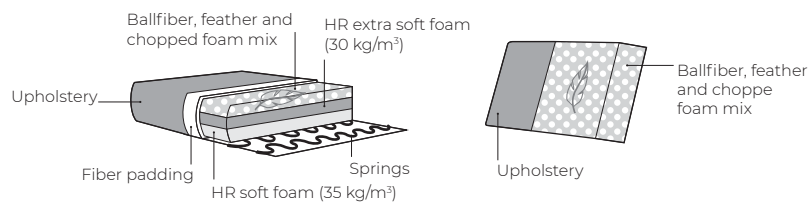

1. Upholstery



2. Legs



IMPORTANT:

Upholstered furniture is handmade using soft materials therefore measurements may vary up to +/- 5 cm.
Parts and sets shown in 2D drawings are left-sided. Parts and sets can be mirrored from left to right.

Single parts

Scale 1:100

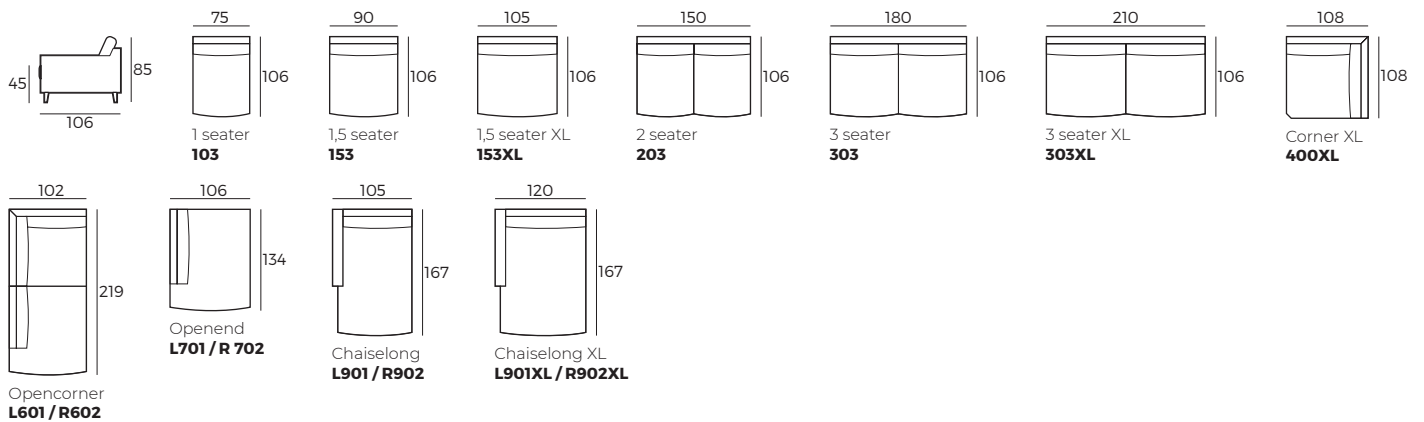

Half sets

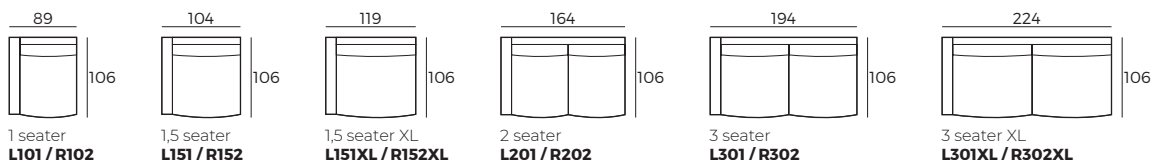

CUSTOM MADE COMFORT

Florida

Sets

Scale 1:100

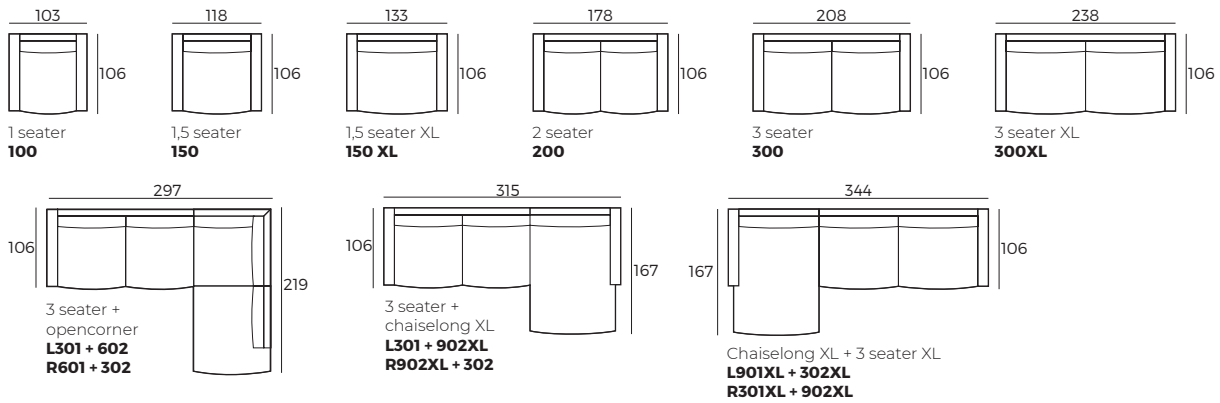

Accessories

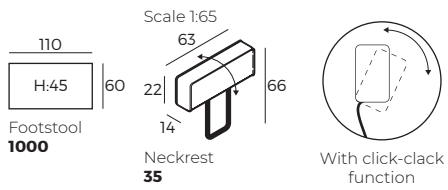

Flyer



Flyer



Comfort

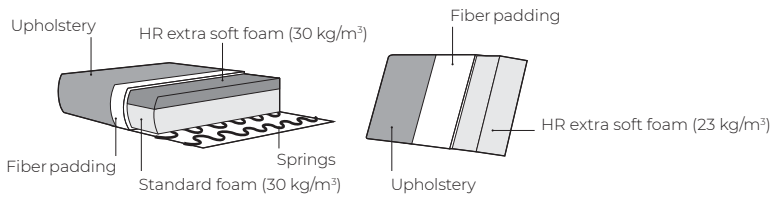

1. Upholstery

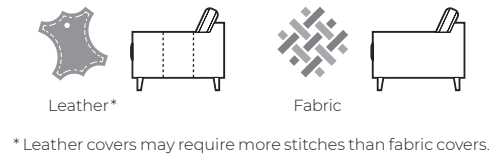

2. Headrest & seat type

*Measures with fully opened mechanism

- ① Manual ↶ / Electrical ⏻
- ② Electrical ⏻

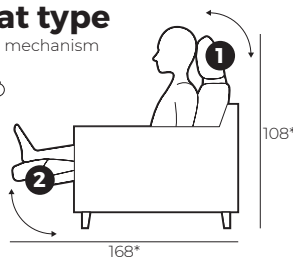

3. Armrest function



Fully closed W 11 x D 98 x H 66
Fully opened W 23 x D 98 x H 51

4. Bi-Color option

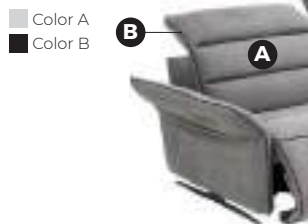

5. Legs



IMPORTANT:

Upholstered furniture is handmade using soft materials therefore measurements may vary up to +/- 5 cm.
 Parts and sets shown in 2D drawings are left-sided. Parts and sets can be mirrored from left to right.

Single parts (Measurements with fully opened armrest)

Scale 1:100

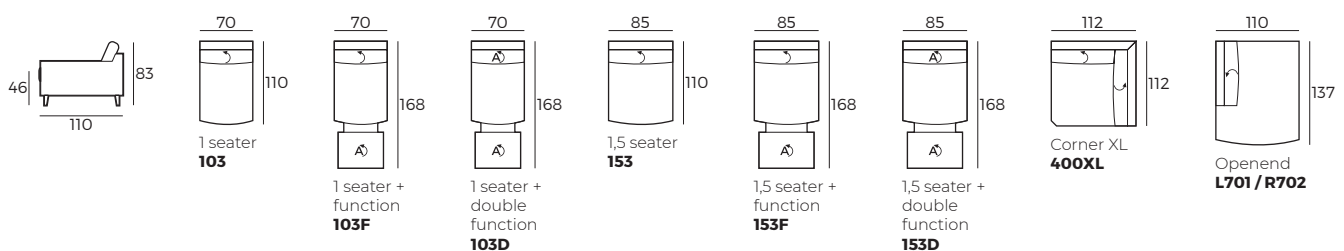

CUSTOM MADE COMFORT

Flyer

Single parts (Measurements with fully opened armrest)

Scale 1:100

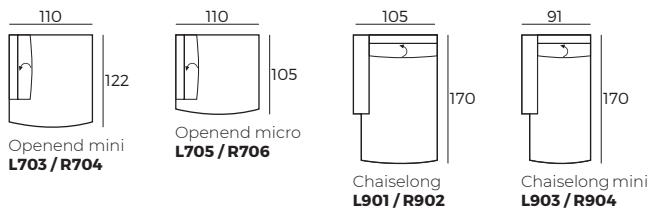

Half sets (Measurements with fully opened armrest)

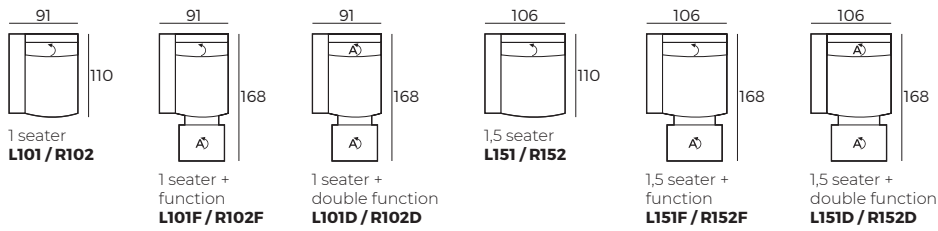

Sets (Measurements with fully opened armrest)

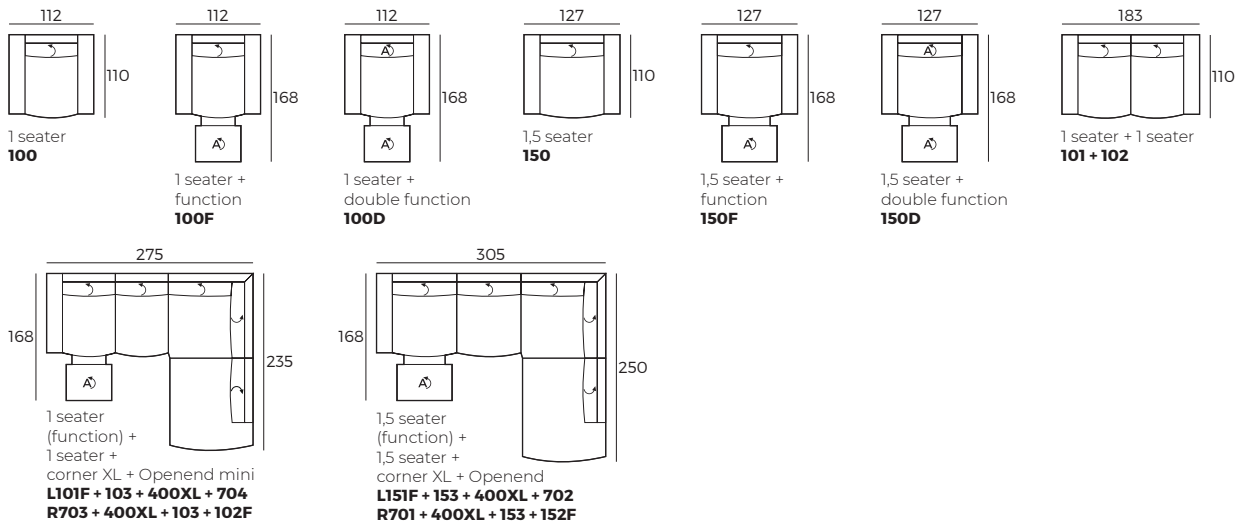

Accessories

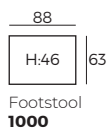

↵ - manual; Ⓐ - electrical *F - single electric function; *D - double electric function

Folkland



Folkland



Comfort

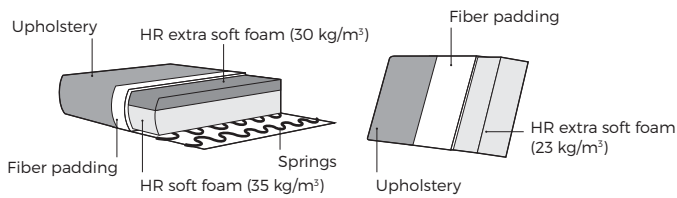

1. Upholstery



2. Legs



IMPORTANT:

Upholstered furniture is handmade using soft materials therefore measurements may vary up to **+/- 5 cm**.
Parts and sets shown in 2D drawings are left-sided. Parts and sets can be mirrored from left to right.

Single parts

Scale 1:100

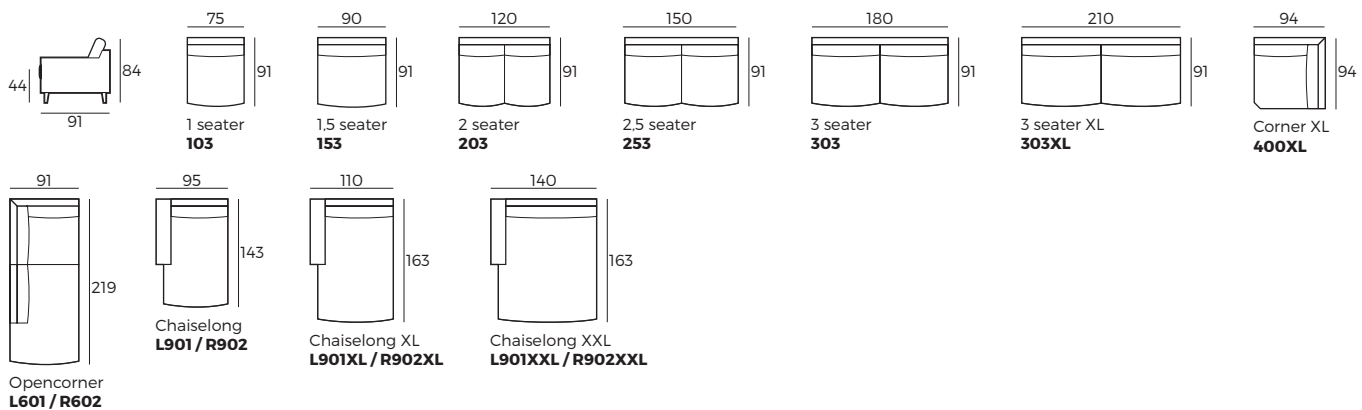

Half sets

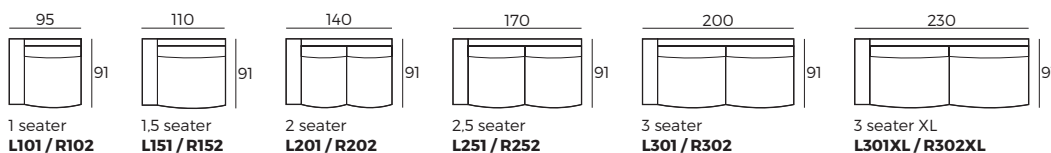

Sets

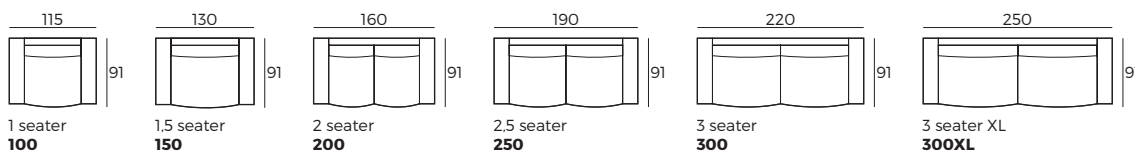

CUSTOM MADE COMFORT

Folkland

Accessories

Scale 1:100



Footstool
1000

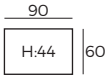

Footstool
1001

Fulham



Fulham



Comfort

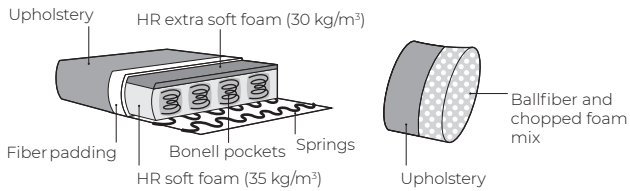

1. Upholstery



2. Legs

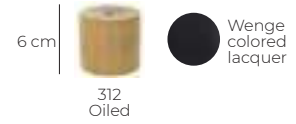

IMPORTANT:

Upholstered furniture is handmade using soft materials therefore measurements may vary up to **+/- 5 cm**.
Parts and sets shown in 2D drawings are left-sided. Parts and sets can be mirrored from left to right.

Single parts

Scale 1:100

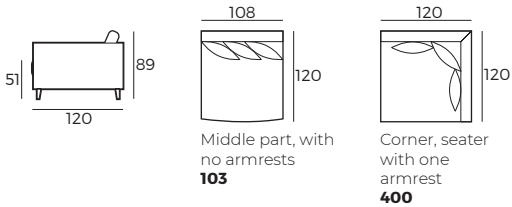

Accessories

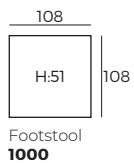

Geronimo



Geronimo



Comfort

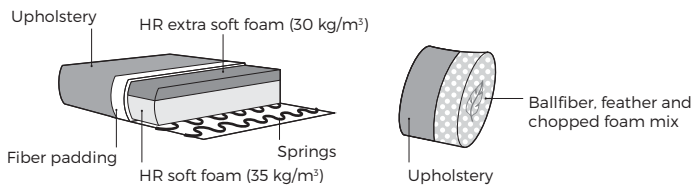

1. Upholstery

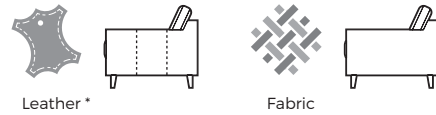

* Leather covers may require more stitches than fabric covers.

2. Legs



IMPORTANT:

Upholstered furniture is handmade using soft materials therefore measurements may vary up to +/- 5 cm.
Parts and sets shown in 2D drawings are left-sided. Parts and sets can be mirrored from left to right.

Sets

Scale 1:100

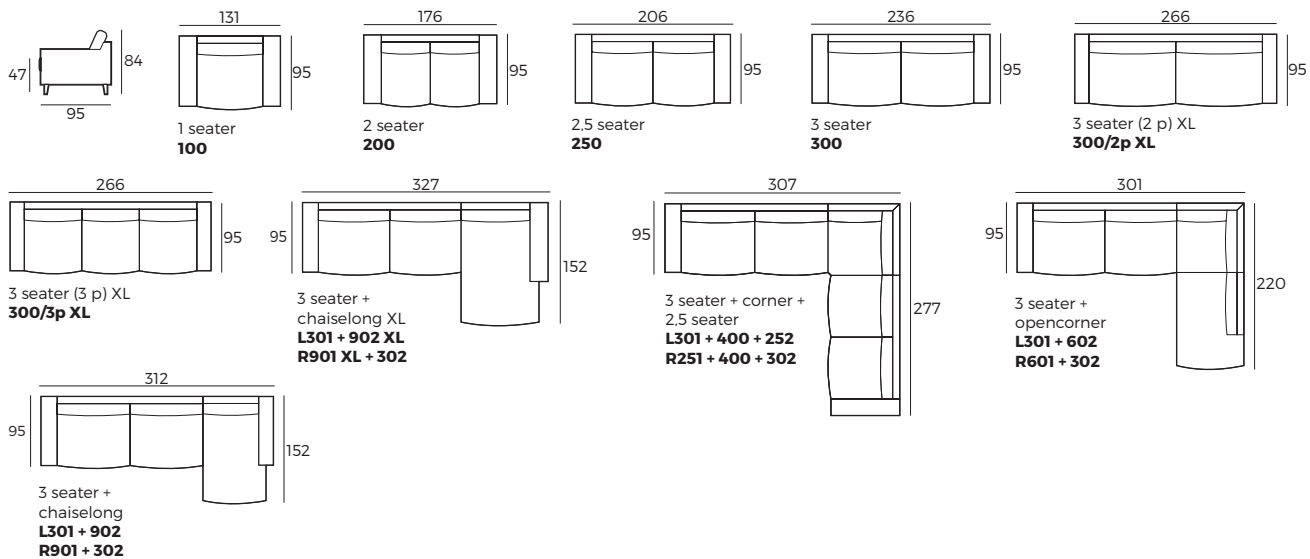

CUSTOM MADE COMFORT

Geronimo

Accessories

Scale 1:100

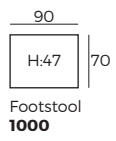

Göteborg



Göteborg



Comfort

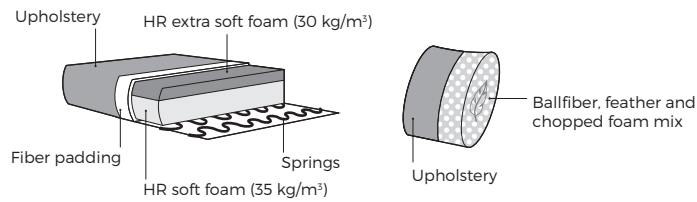

1. Upholstery

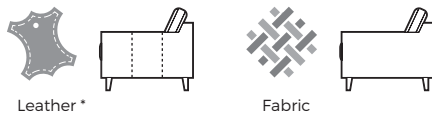

* Leather covers may require more stitches than fabric covers.

2. Choose pillows



3. Legs

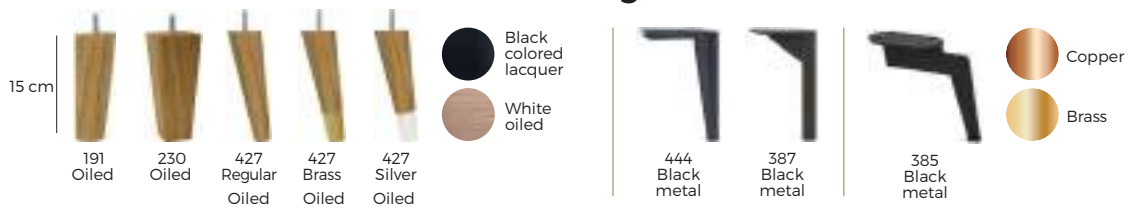

IMPORTANT:

Upholstered furniture is handmade using soft materials therefore measurements may vary up to +/- 5 cm.
Parts and sets shown in 2D drawings are left-sided. Parts and sets can be mirrored from left to right.

Single parts

Scale 1:100

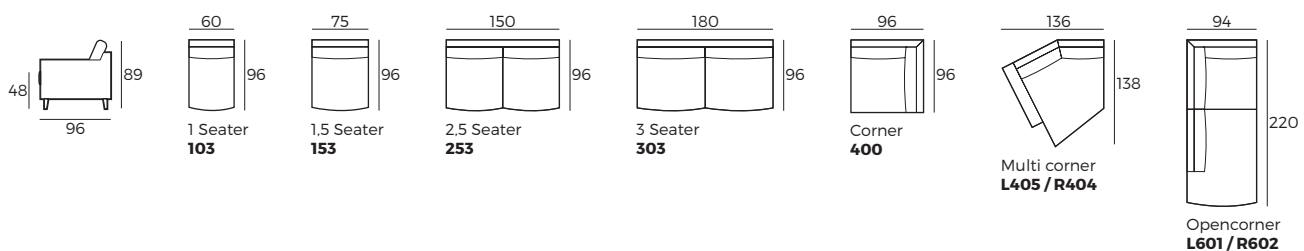

CUSTOM MADE COMFORT

Göteborg

Scale 1:100

Single parts

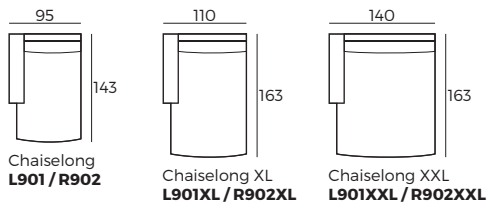

Half sets

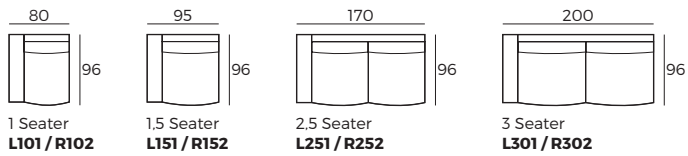

Sets

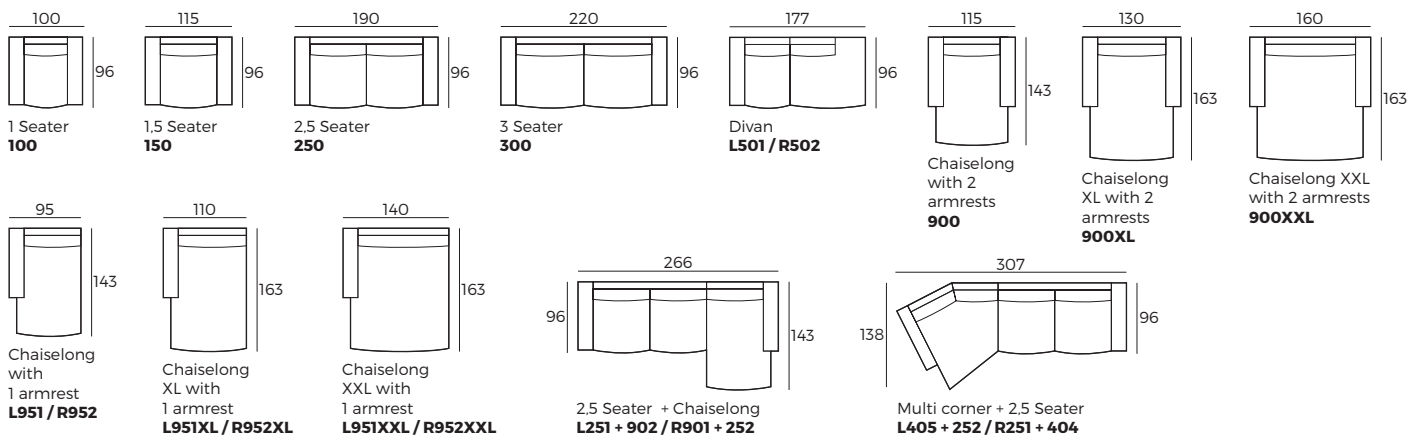

Accessories

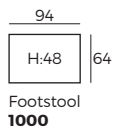

Gotland



Gotland



Comfort

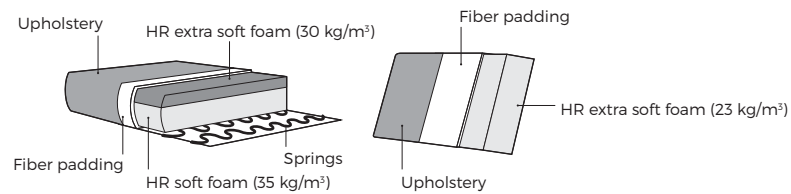

1. Upholstery



* Leather covers may require more stitches than fabric covers.

2. Legs

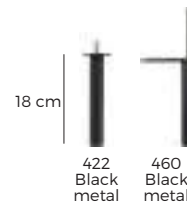

IMPORTANT:

Upholstered furniture is handmade using soft materials therefore measurements may vary up to **+/- 5 cm**.
Parts and sets shown in 2D drawings are left-sided. Parts and sets can be mirrored from left to right.

Single parts

Scale 1:100

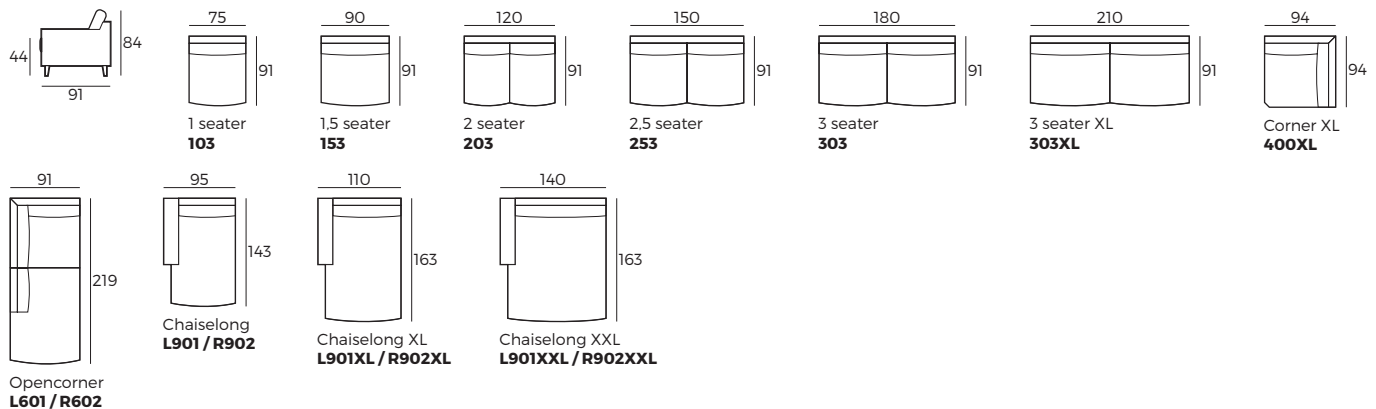

Gotland

Half sets

Scale 1:100

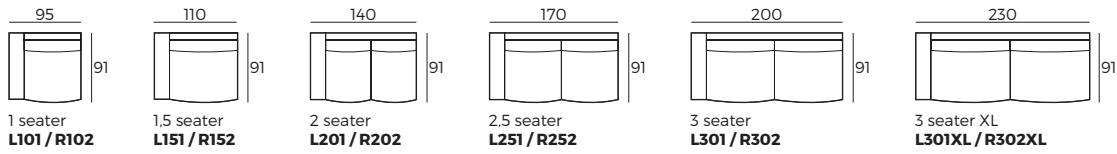

Sets

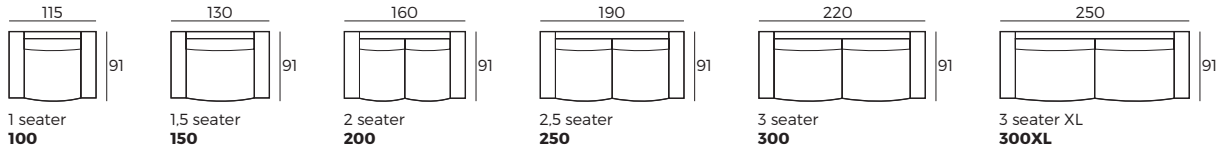

Accessories

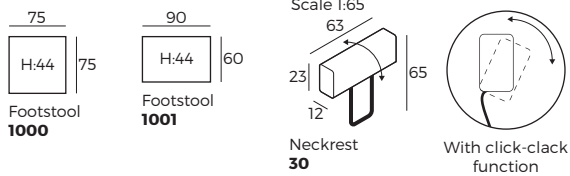

Goya



Goya



Comfort

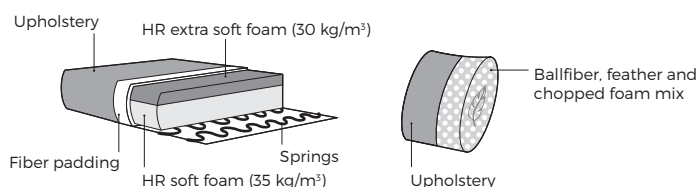

1. Upholstery

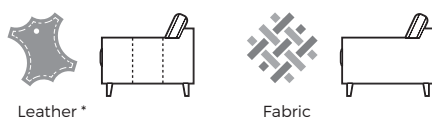

* Leather covers may require more stitches than fabric covers.

2. Legs



IMPORTANT:

Upholstered furniture is handmade using soft materials therefore measurements may vary up to +/- 5 cm.
 Parts and sets shown in 2D drawings are left-sided. Parts and sets can be mirrored from left to right.

Single parts

Scale 1:100

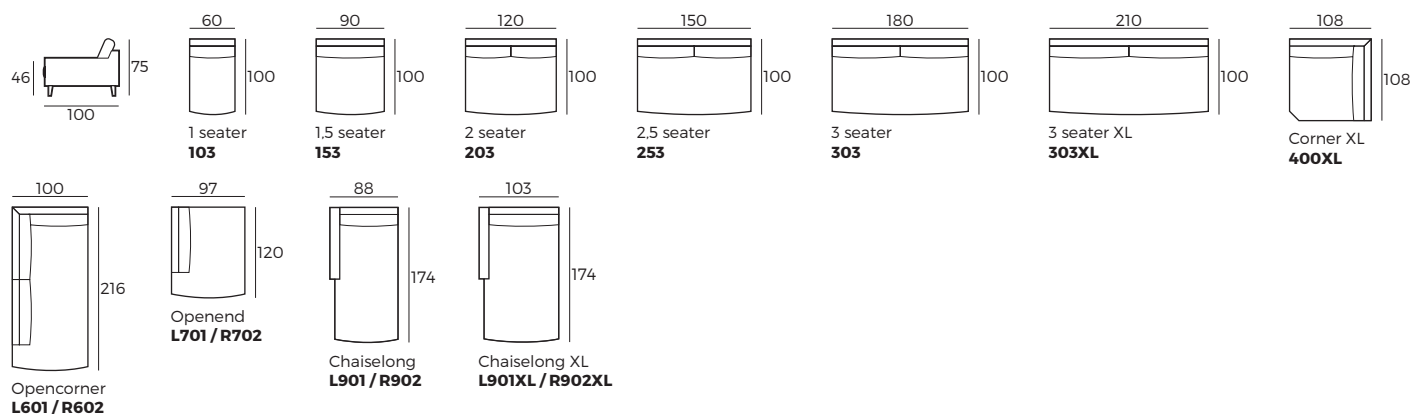

CUSTOM MADE COMFORT

Goya

Half sets

Scale 1:100

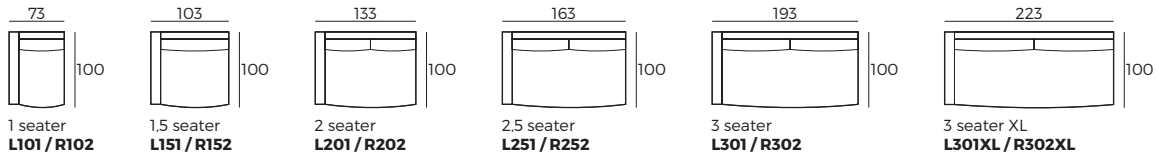

Sets

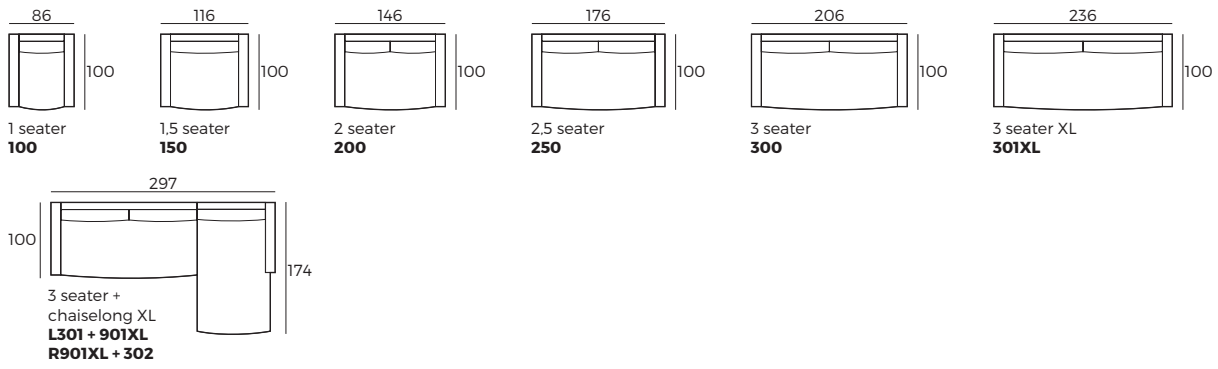

Accessories

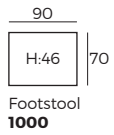

Hammington



Hammington



Comfort

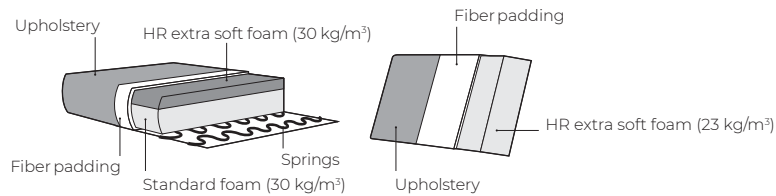

1. Upholstery



* Leather covers may require more stitches than fabric covers.

2. Headrest & seat type

*Measures with fully opened mechanism

- 1 Manual ↶ / Electrical ⤴
- 2 Electrical ⤴

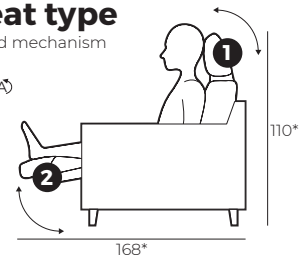

3. Armrest function



Fully closed W 11 x D 98 x H 66
Fully opened W 23 x D 98 x H 51

4. Multicolor option



5. Legs



396 Metal

IMPORTANT:

Upholstered furniture is handmade using soft materials therefore measurements may vary up to +/- 5 cm.
 Parts and sets shown in 2D drawings are left-sided. Parts and sets can be mirrored from left to right.

Single parts (Measurements with fully opened armrest)

Scale 1:100

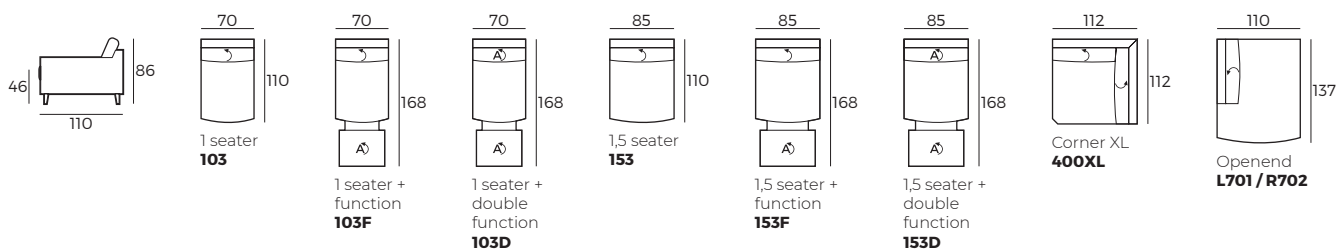

Hammington

Single parts (Measurements with fully opened armrest)

Scale 1:100

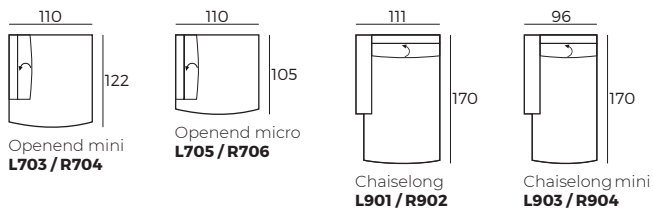

Half sets (Measurements with fully opened armrest)

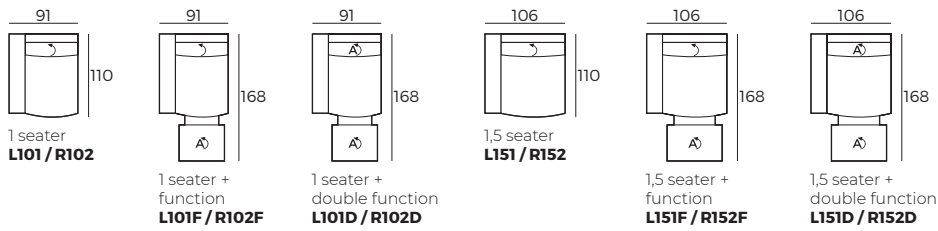

Sets (Measurements with fully opened armrest)

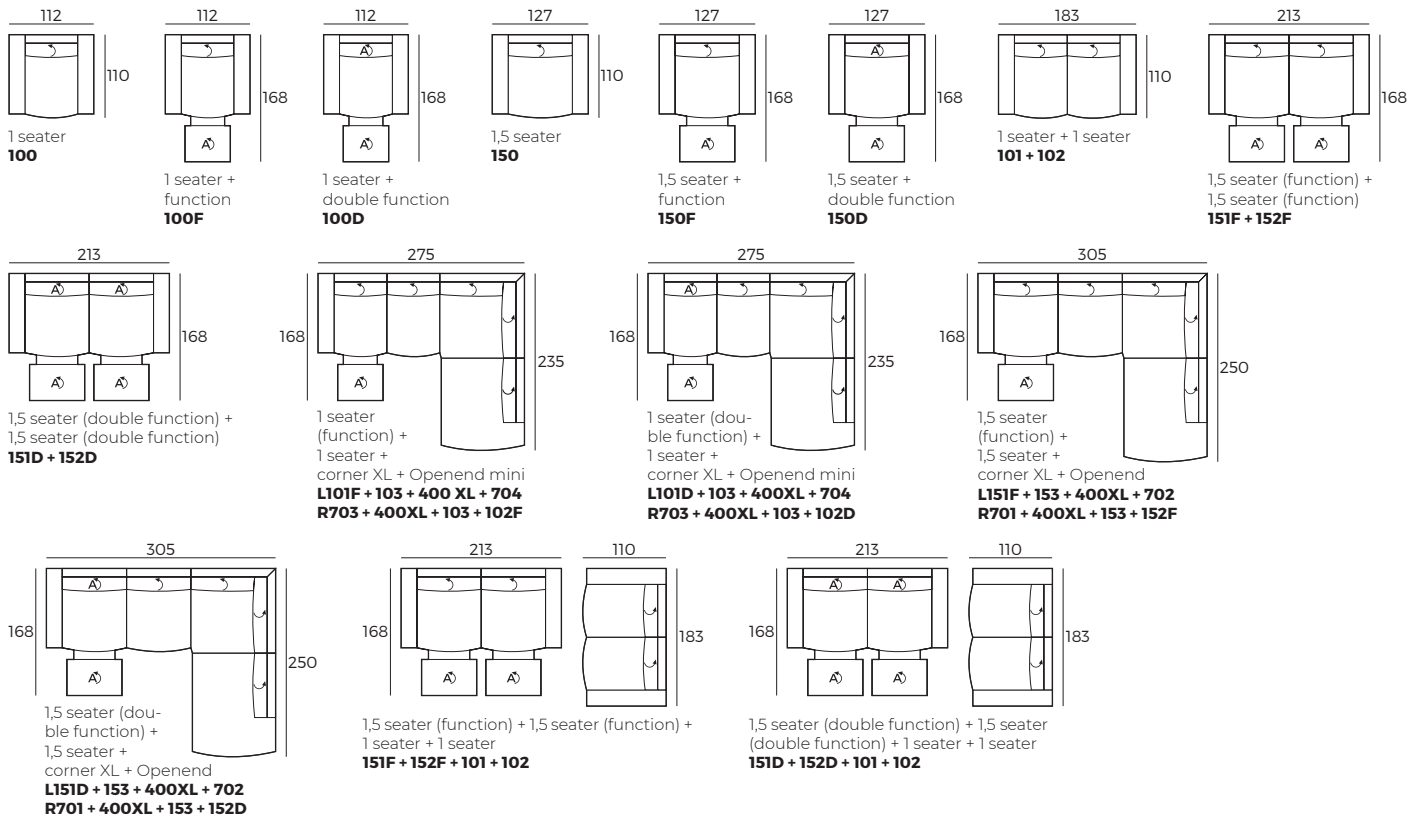

Accessories

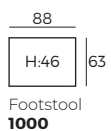

↷ - manual; ⚡ - electrical; *F - single electric function; *D - double electric function

Hanna



Hanna



Comfort

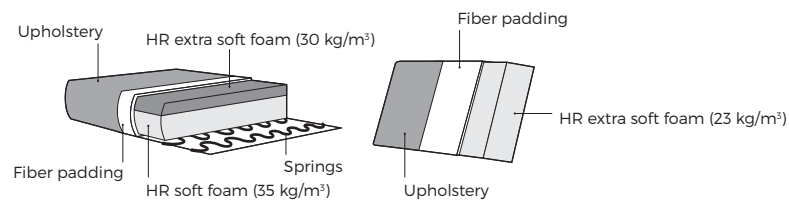

1. Upholstery



Fabric

2. Choose pillows

Multi corner



Pillow **P**



Pillow **B**

3. Legs



IMPORTANT:

Upholstered furniture is handmade using soft materials therefore measurements may vary up to +/- 5 cm.
Parts and sets shown in 2D drawings are left-sided. Parts and sets can be mirrored from left to right.

Single parts

Scale 1:100

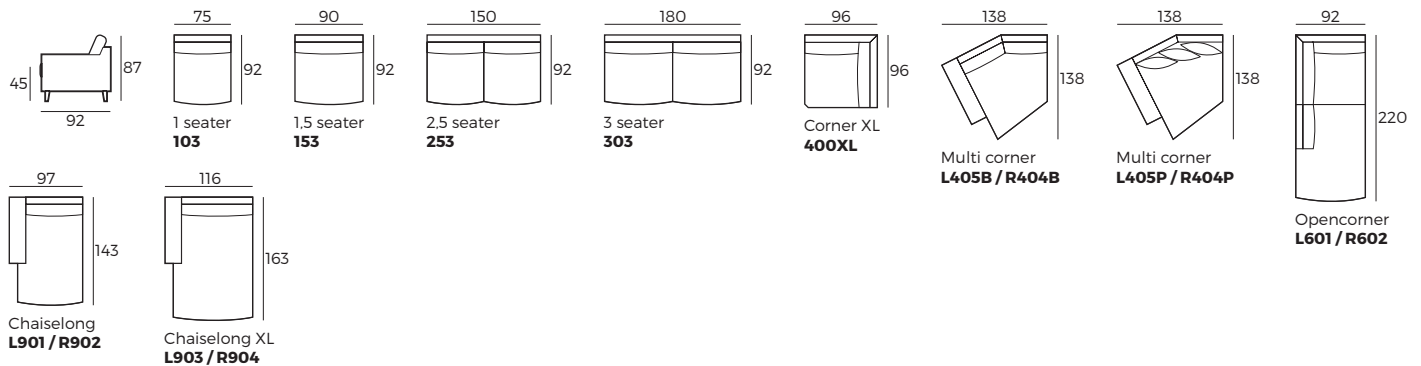

Half sets

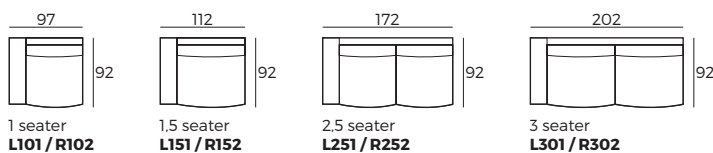

CUSTOM MADE COMFORT

Hanna

Sets

Scale 1:100

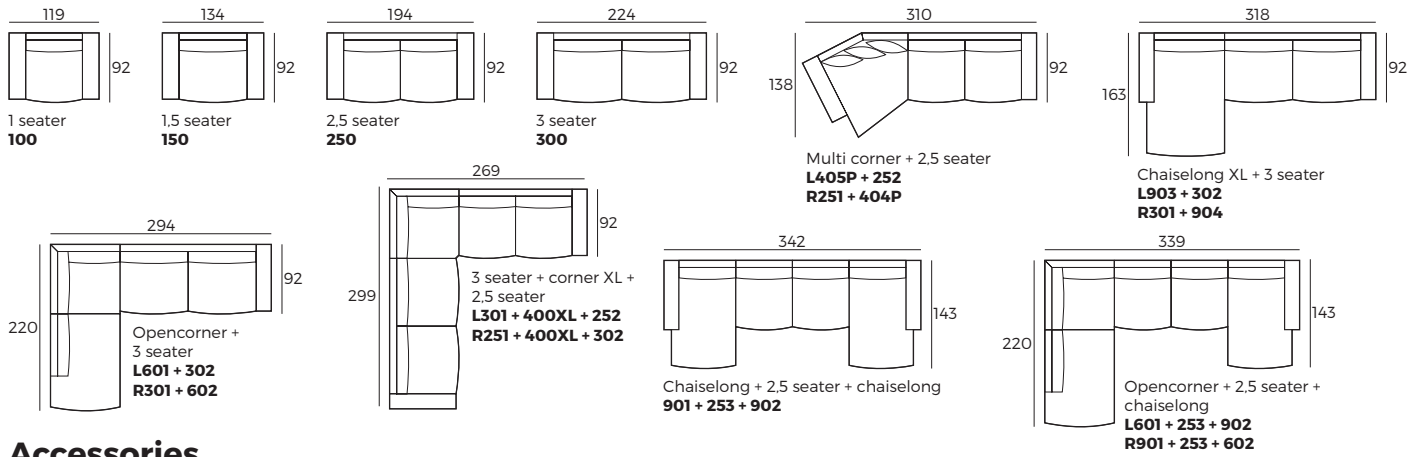

Accessories

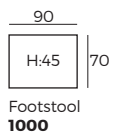

Harold



Harold



Comfort

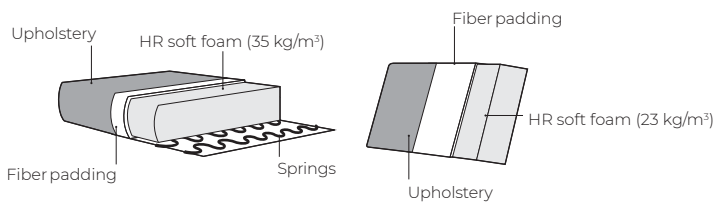

1. Upholstery



Leather*



Fabric

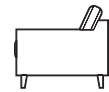

* Leather covers may require more stitches than fabric covers.

2. Choose pillows



Flat

Regular

3. Legs



IMPORTANT:

Upholstered furniture is handmade using soft materials therefore measurements may vary up to ± 5 cm.
Parts and sets shown in 2D drawings are left-sided. Parts and sets can be mirrored from left to right.

Single parts

Scale 1:100

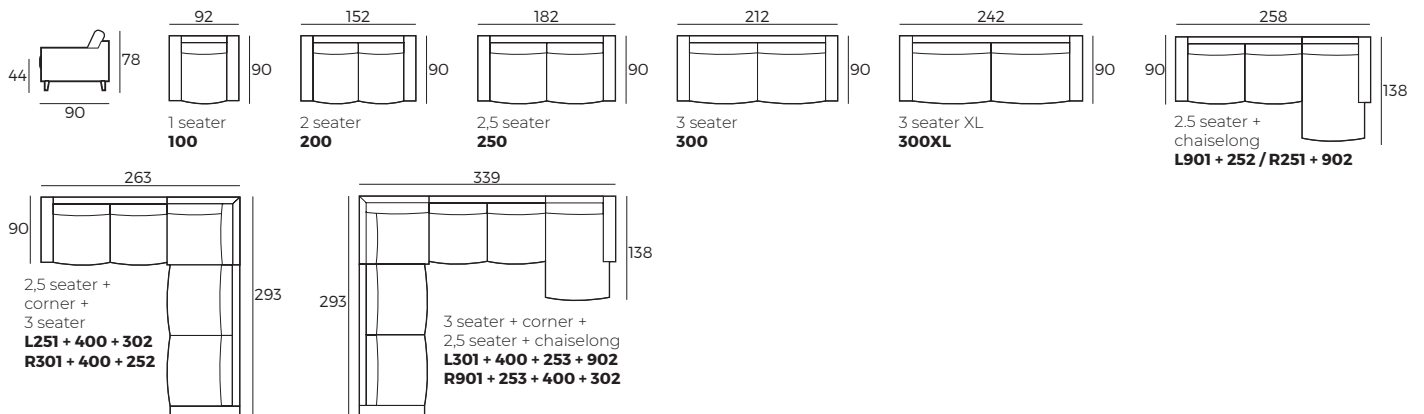

Harold

Accessories

Scale 1:100

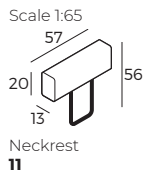
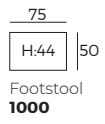

Hedy



Hedy



Comfort

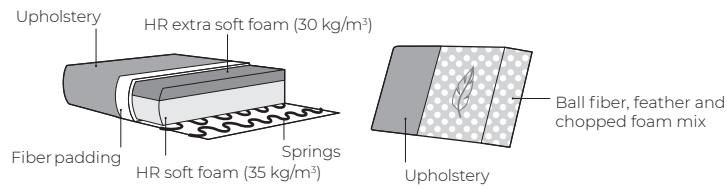

1. Upholstery



Fabric

2. Armrests



Covy

W 21 x D 99 x H 63

Flaty

W 14 x D 99 x H 63

Hedy

W 25 x D 99 x H 63

3. Legs



152 Plastic



279 Wenge colored lacquer



Oiled

IMPORTANT:

Upholstered furniture is handmade using soft materials therefore measurements may vary up to +/- 5 cm.
Parts and sets shown in 2D drawings are left-sided. Parts and sets can be mirrored from left to right.

Single parts (Measurements with Hedy armrest)

Scale 1:100

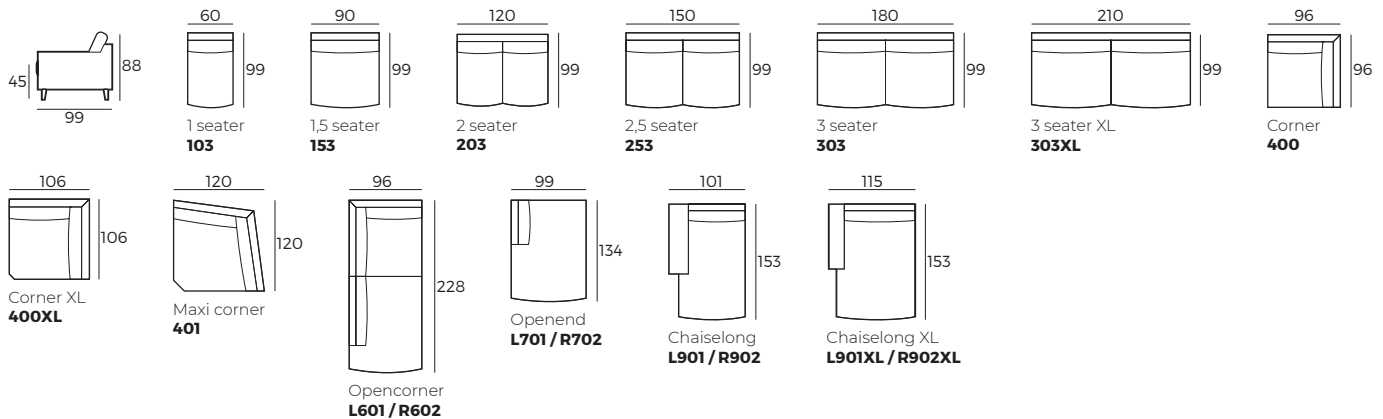

Hedy

Half sets (Measurements with Hedy armrest)

Scale 1:100

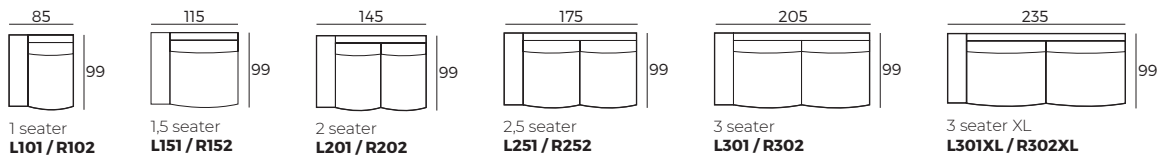

Sets (Measurements with Hedy armrest)

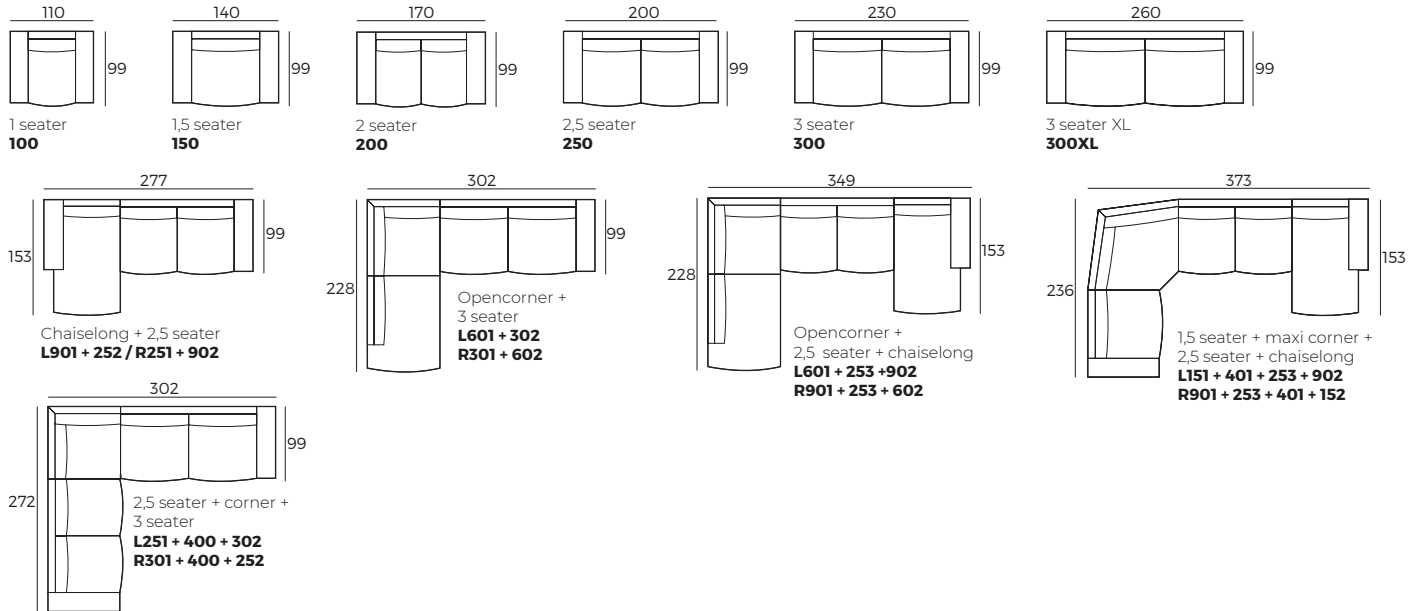

Accessories

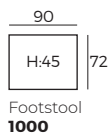

Helena



Helena



Comfort

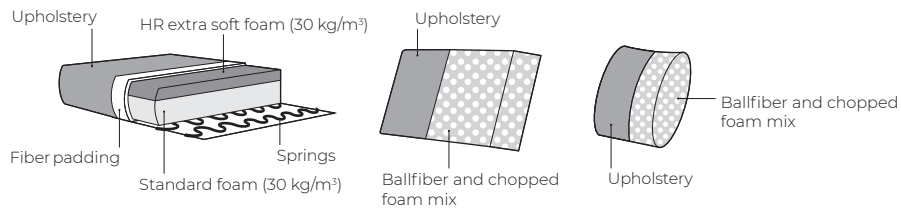

1. Upholstery



2. Armrests



Covy

W 21 x D 96 x H 63



Hedy

W 25 x D 96 x H 63



Flaty

W 14 x D 96 x H 63



Gaby

W 25 x D 96 x H 63

3. Choose pillows



Pillow **B**



Pillow **P***

* Only fabric option for this pillow.

4. Legs



IMPORTANT:

Upholstered furniture is handmade using soft materials therefore measurements may vary up to +/- 5 cm.
Parts and sets shown in 2D drawings are left-sided. Parts and sets can be mirrored from left to right.

Single parts (Measurements with Hedy armrest)

Scale 1:100

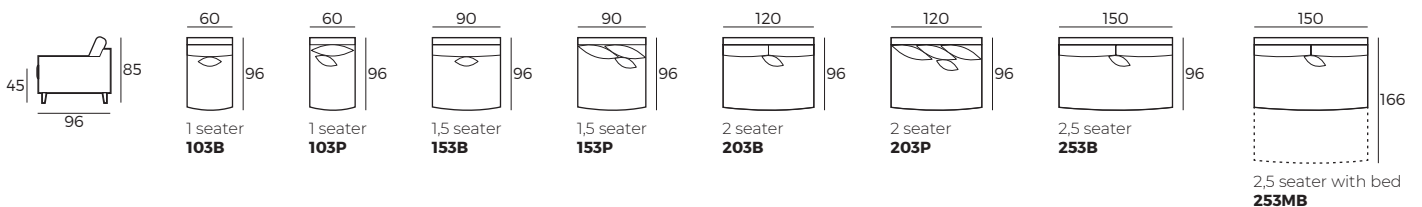

CUSTOM MADE COMFORT

Helena

Single parts (Measurements with Hedy armrest)

Scale 1:100

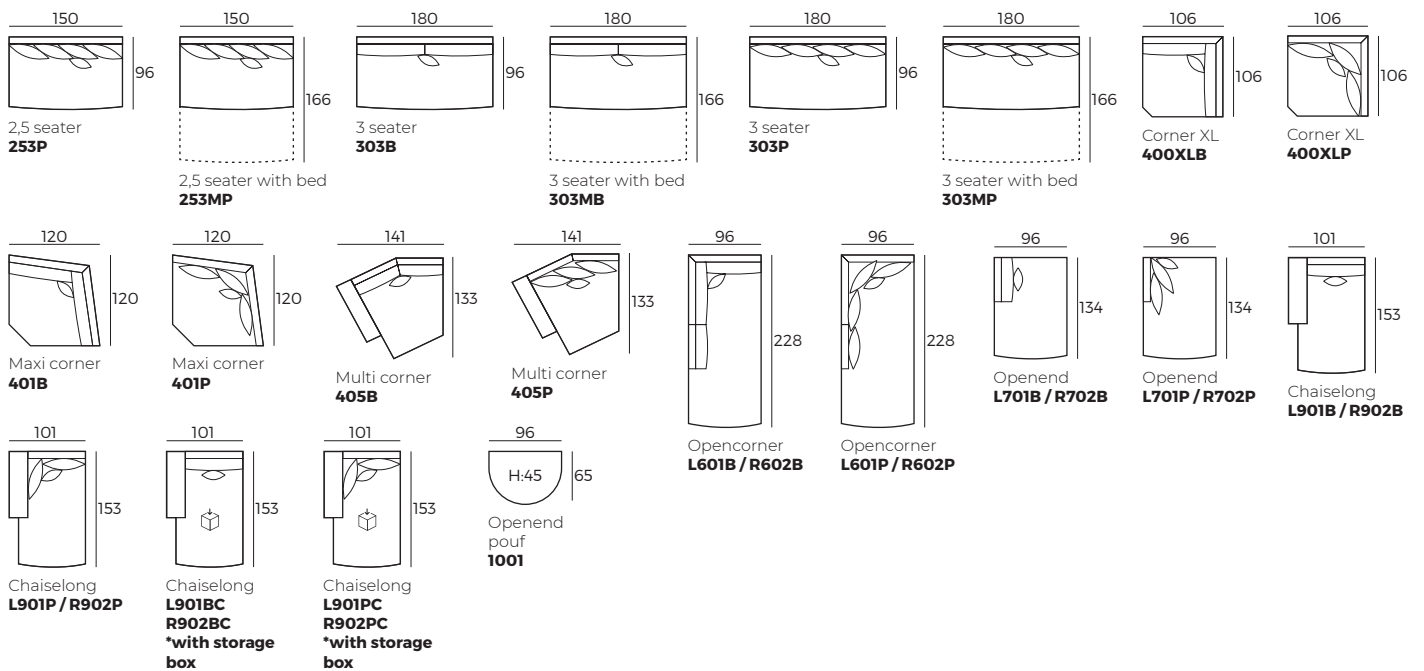

Half-sets (Measurements with Hedy armrest)

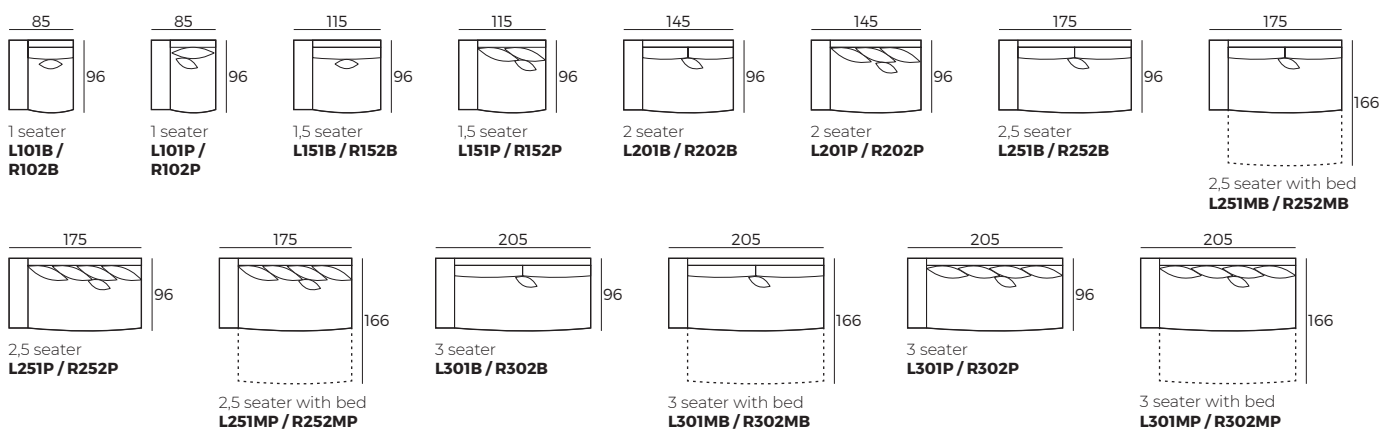

Sets (Measurements with Hedy armrest)

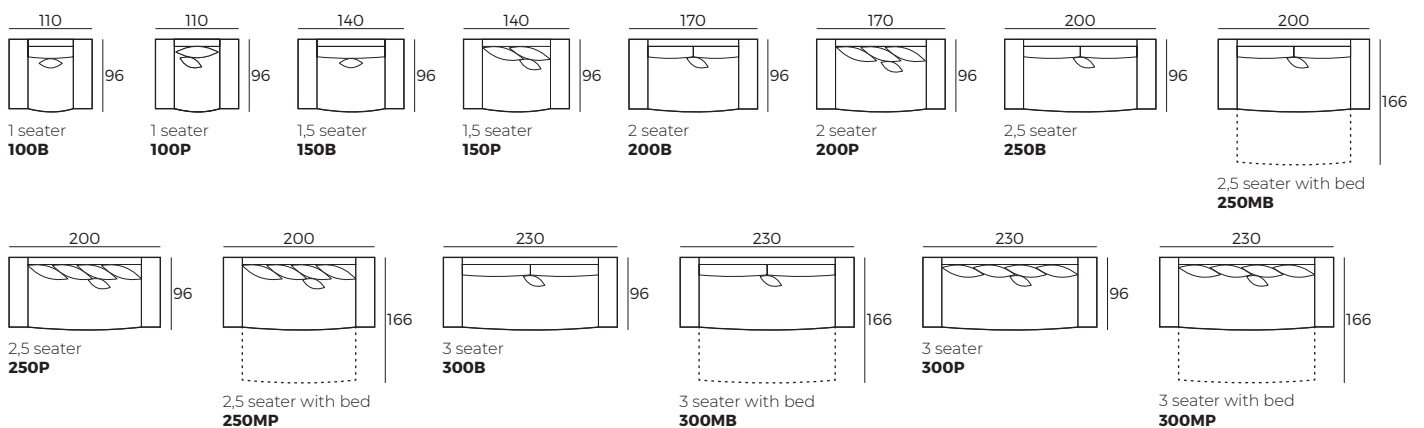

Accessories

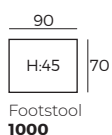

Hendi



Hendi



Comfort

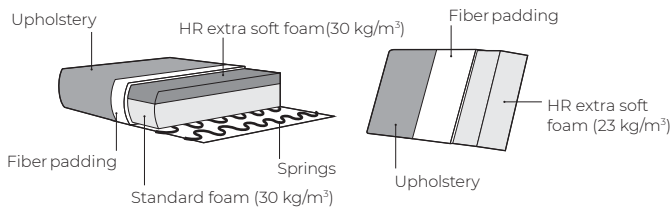

1. Upholstery



Fabric

3. Legs



Chaiselong footstool assembly

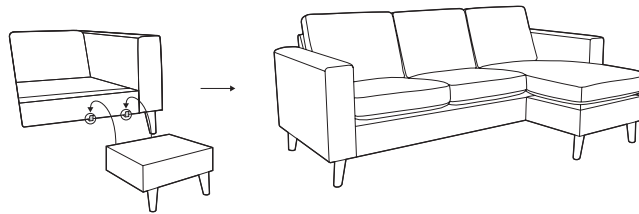

IMPORTANT:

Upholstered furniture is handmade using soft materials therefore measurements may vary up to +/- 5 cm.
Parts and sets shown in 2D drawings are left-sided. Parts and sets can be mirrored from left to right.

Sets

Scale 1:100

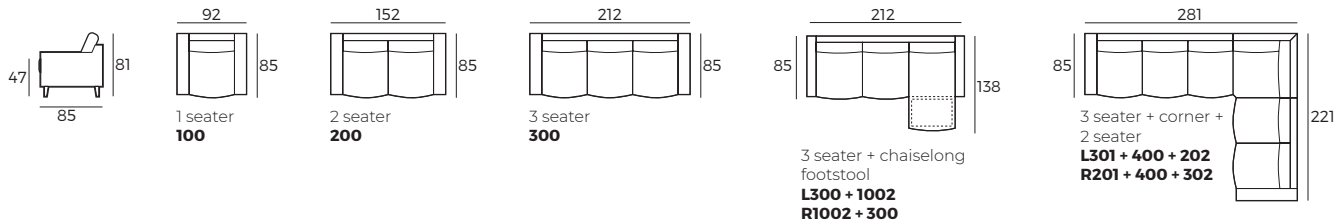

Accessories



Footstool
1000

Holm



Holm



Comfort

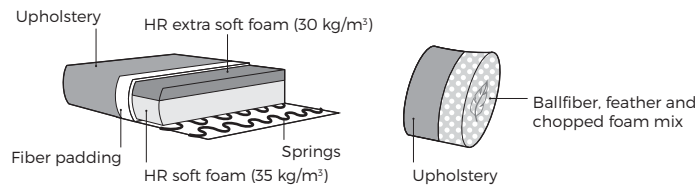

1. Upholstery



2. Legs



IMPORTANT:

Upholstered furniture is handmade using soft materials therefore measurements may vary up to +/- 5 cm.

Sets

Scale 1:100

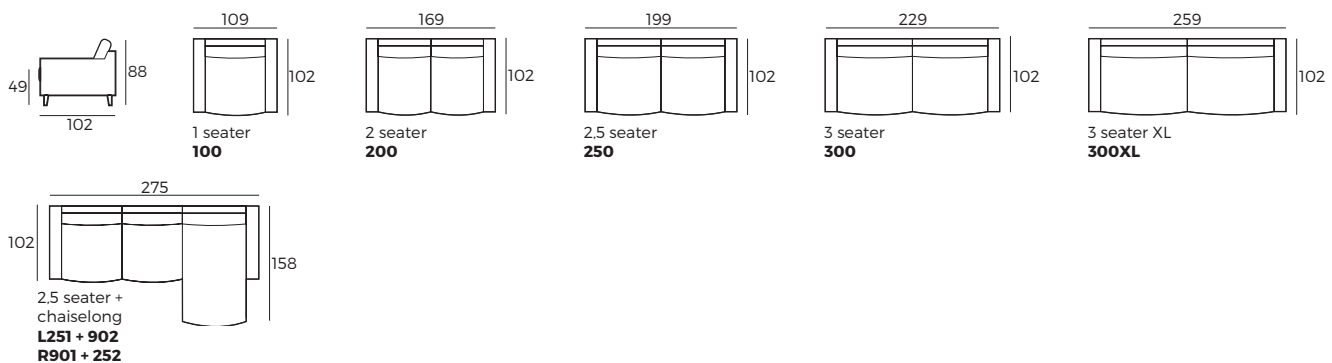

Accessories

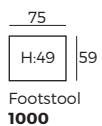

Igor



Igor



Comfort

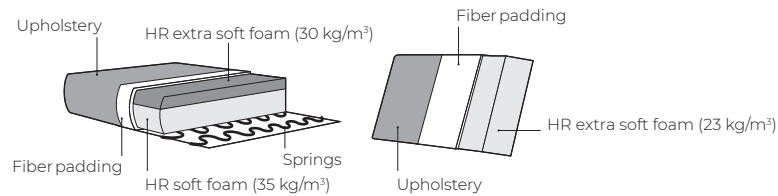

1. Upholstery



* Leather covers may require more stitches than fabric covers.

2. Headrest & seat type

*Measures with fully opened mechanism

- 1 Manual ↷
- 2 Electrical ⤴

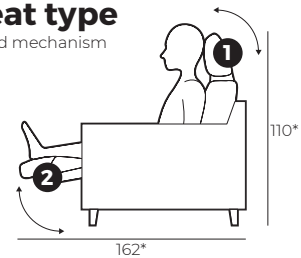

3. Armrests

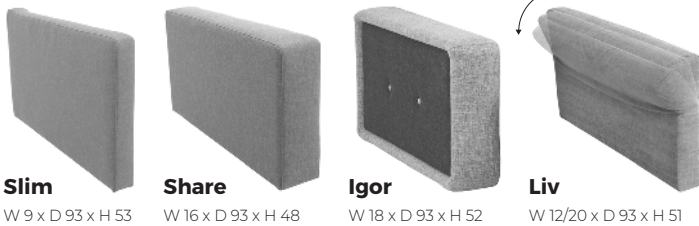

4. Bi-Color option

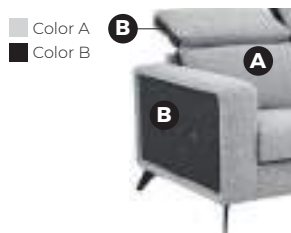

5. Legs



IMPORTANT:

Upholstered furniture is handmade using soft materials therefore measurements may vary up to +/- 5 cm.
Parts and sets shown in 2D drawings are left-sided. Parts and sets can be mirrored from left to right.

Single parts (Measurements with Liv armrest)

Scale 1:100

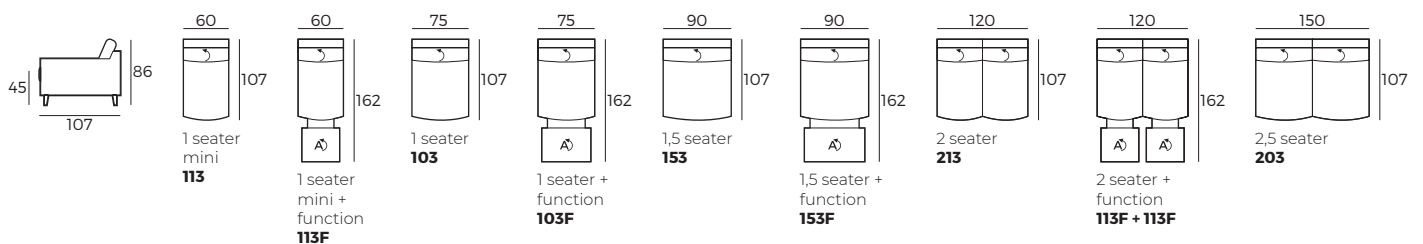

Igor

Single parts (Measurements with Liv armrest)

Scale 1:100

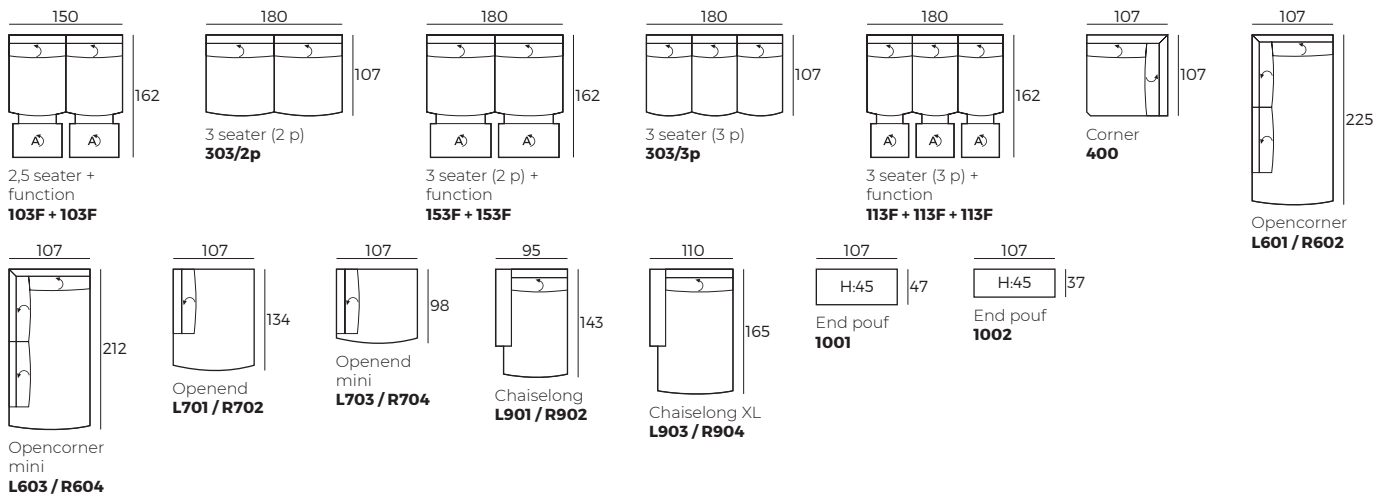

Half sets (Measurements with Liv armrest)

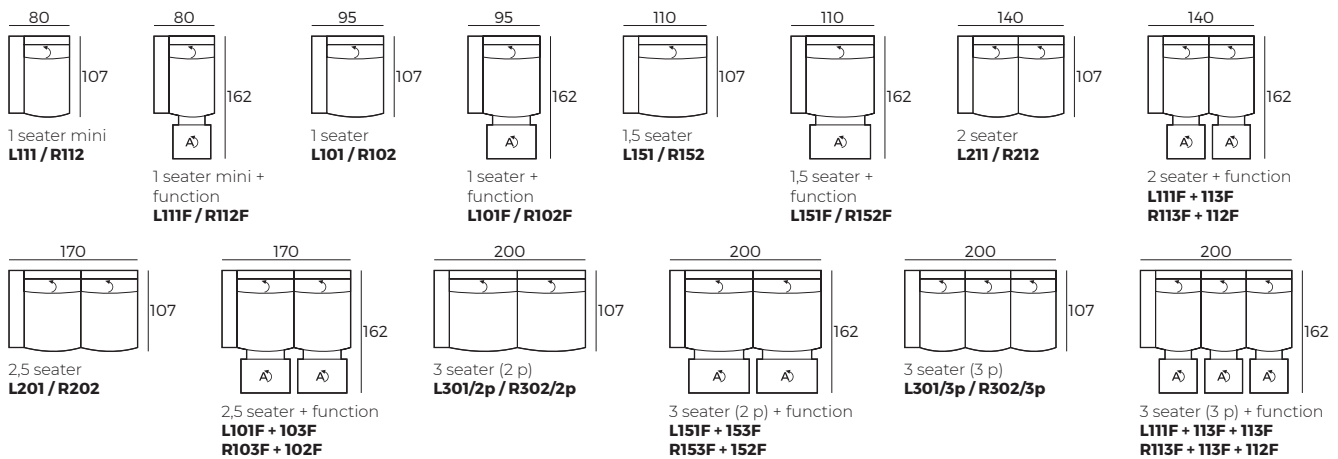

Sets (Measurements with Liv armrest)

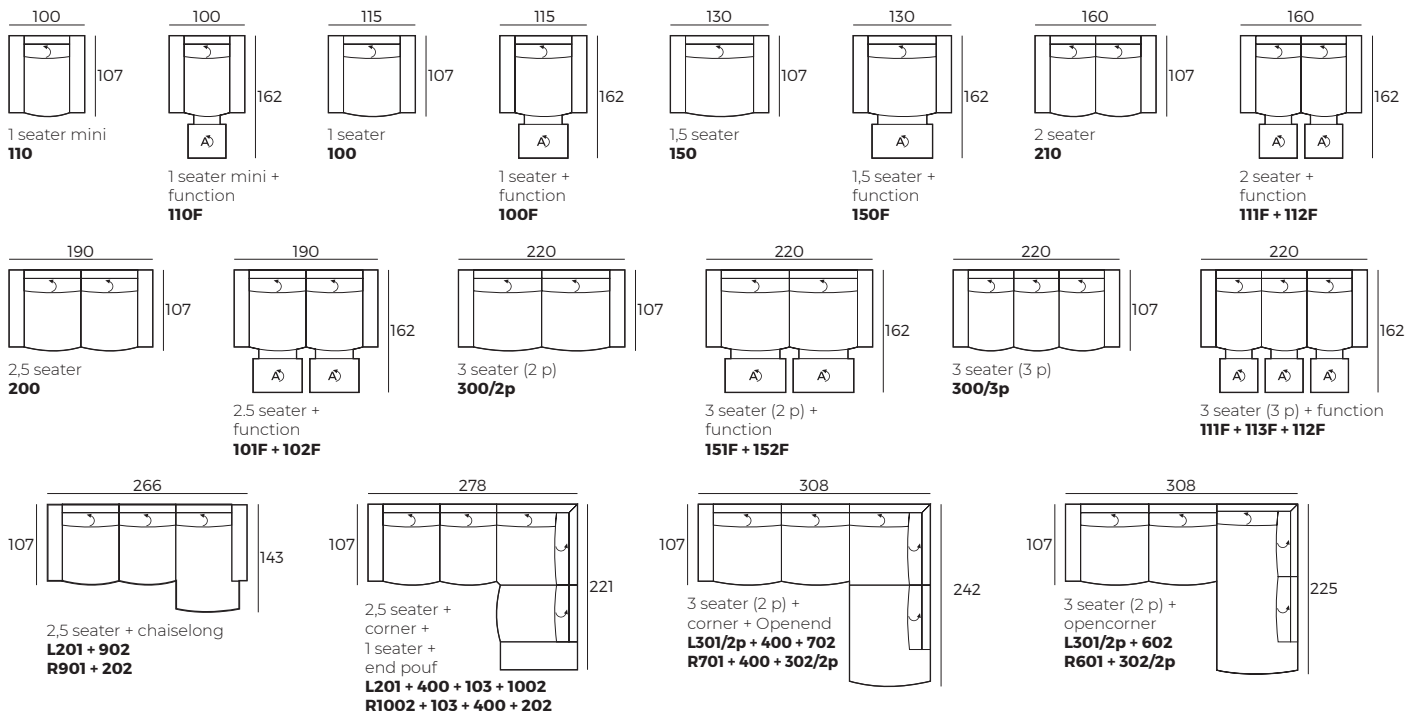

Igor

Sets (Measurements with Liv armrest)

Scale 1:100

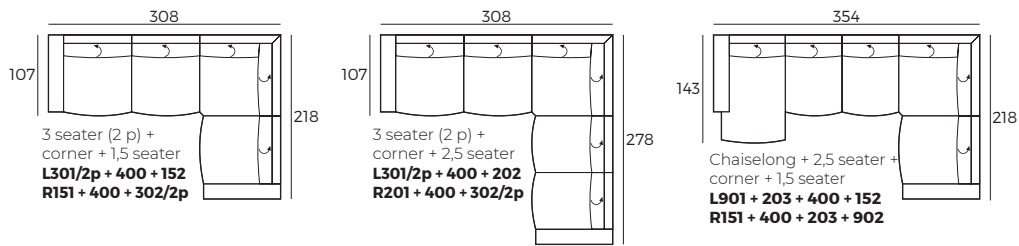

Accessories

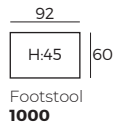

› - manual; Ⓐ - electrical *F - single electric function

Inga



Inga



Comfort

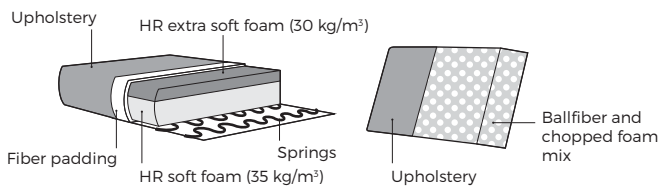

1. Upholstery



* Leather covers may require more stitches than fabric covers.

2. Armrests



1 W 18 x D 90 x H 54
2 W 19 x D 90 x H 54
3 W 17 x D 90 x H 54

3. Legs



IMPORTANT:

Upholstered furniture is handmade using soft materials therefore measurements may vary up to +/- 5 cm.
 Parts and sets shown in 2D drawings are left-sided. Parts and sets can be mirrored from left to right.

Single parts (Measurements with 3 armrest)

Scale 1:100

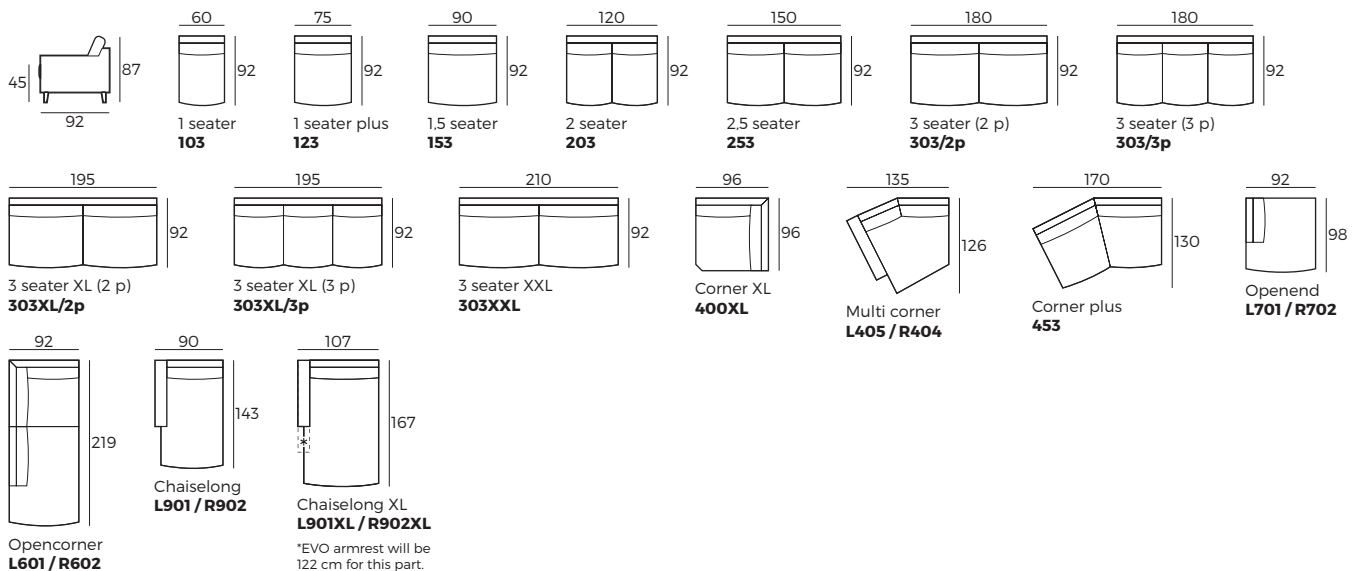

Inga

Half sets (Measurements with 3 armrest)

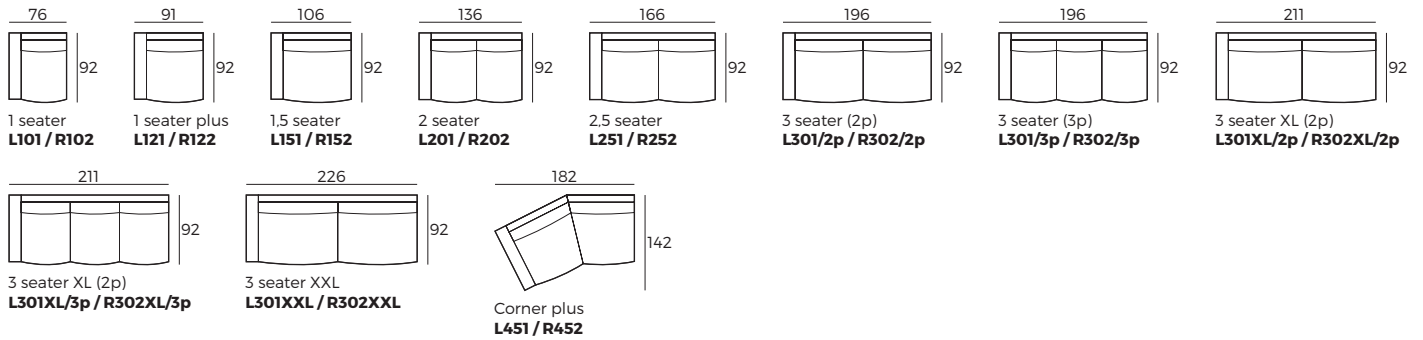

Sets (Measurements with 3 armrest)

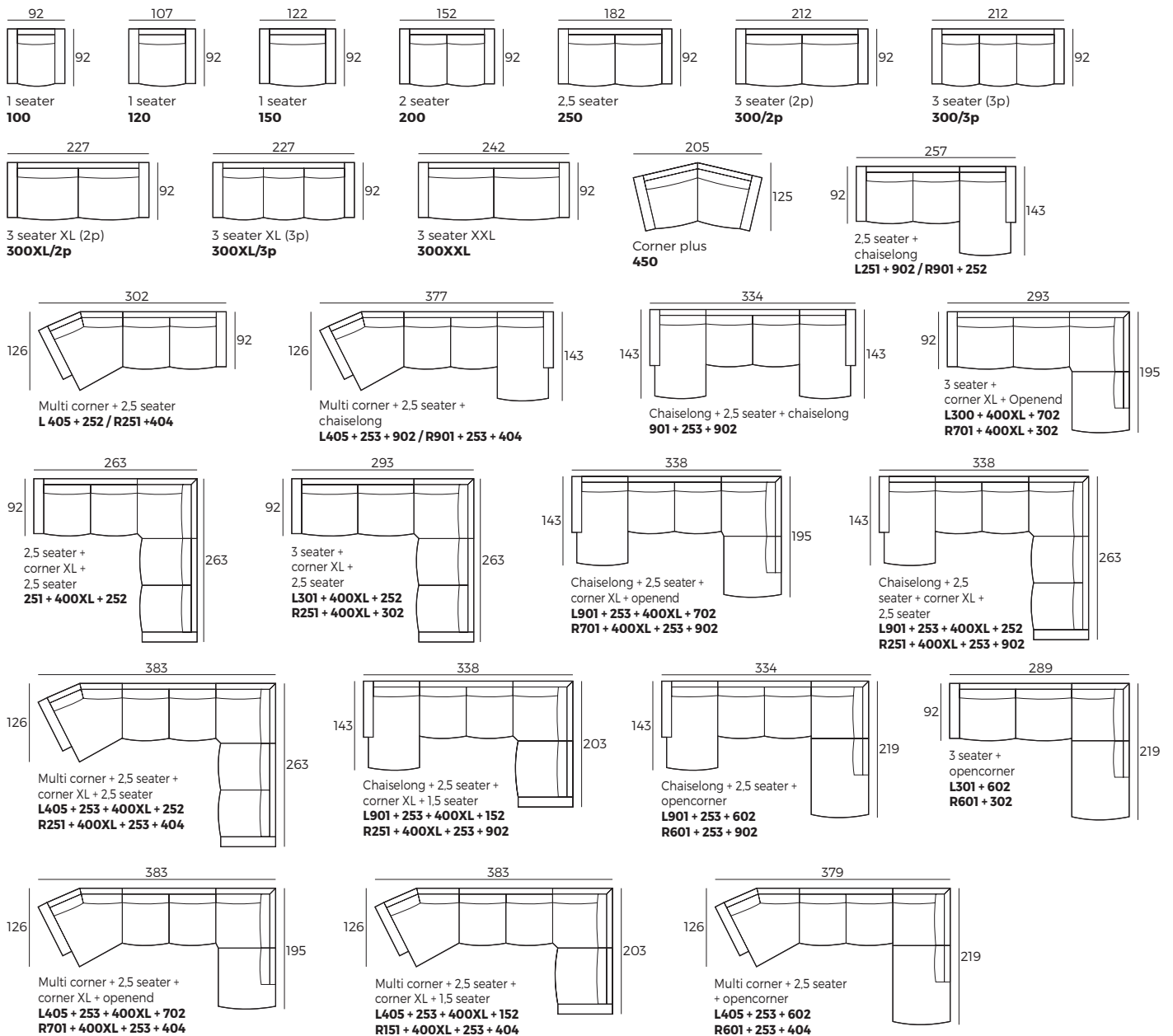

Joana



Joana



Comfort

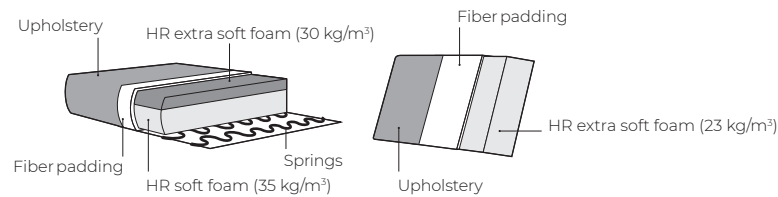

1. Upholstery



* Leather covers may require more stitches than fabric covers.

2. Headrest & seat type

*Measures with fully opened mechanism

- 1 Manual ↗
- 2 Electrical ⚡

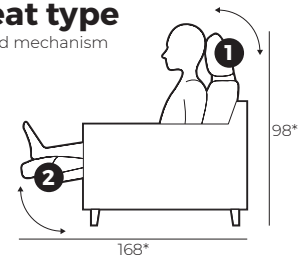

3. Armrest



4. Legs



IMPORTANT:

Upholstered furniture is handmade using soft materials therefore measurements may vary up to +/- 5 cm.
Parts and sets shown in 2D drawings are left-sided. Parts and sets can be mirrored from left to right.

Single parts (Measurements with fully opened armrest)

Scale 1:100

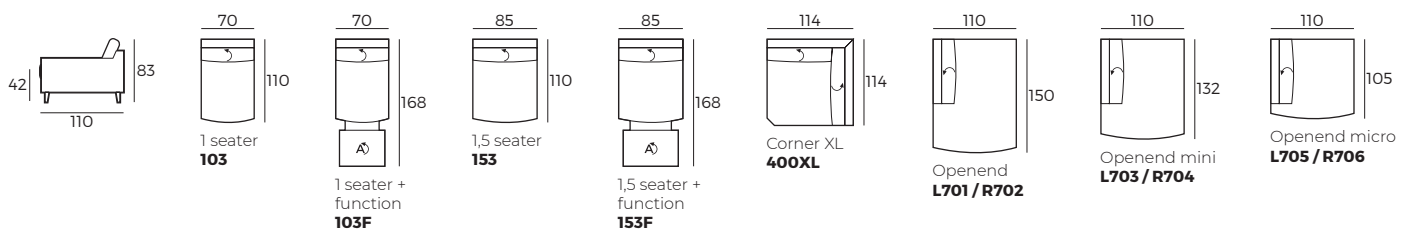

Joana

Single parts (Measurements with fully opened armrest)

Scale 1:100

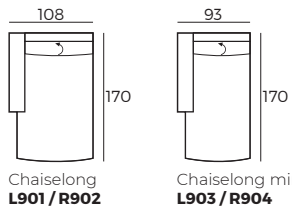

Half sets (Measurements with fully opened armrest)

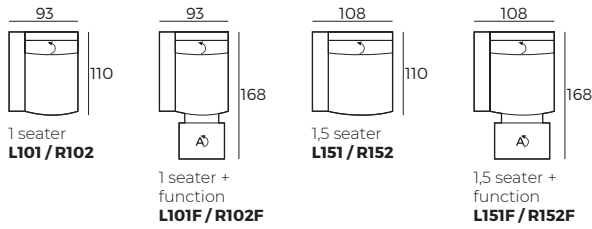

Sets (Measurements with fully opened armrest)

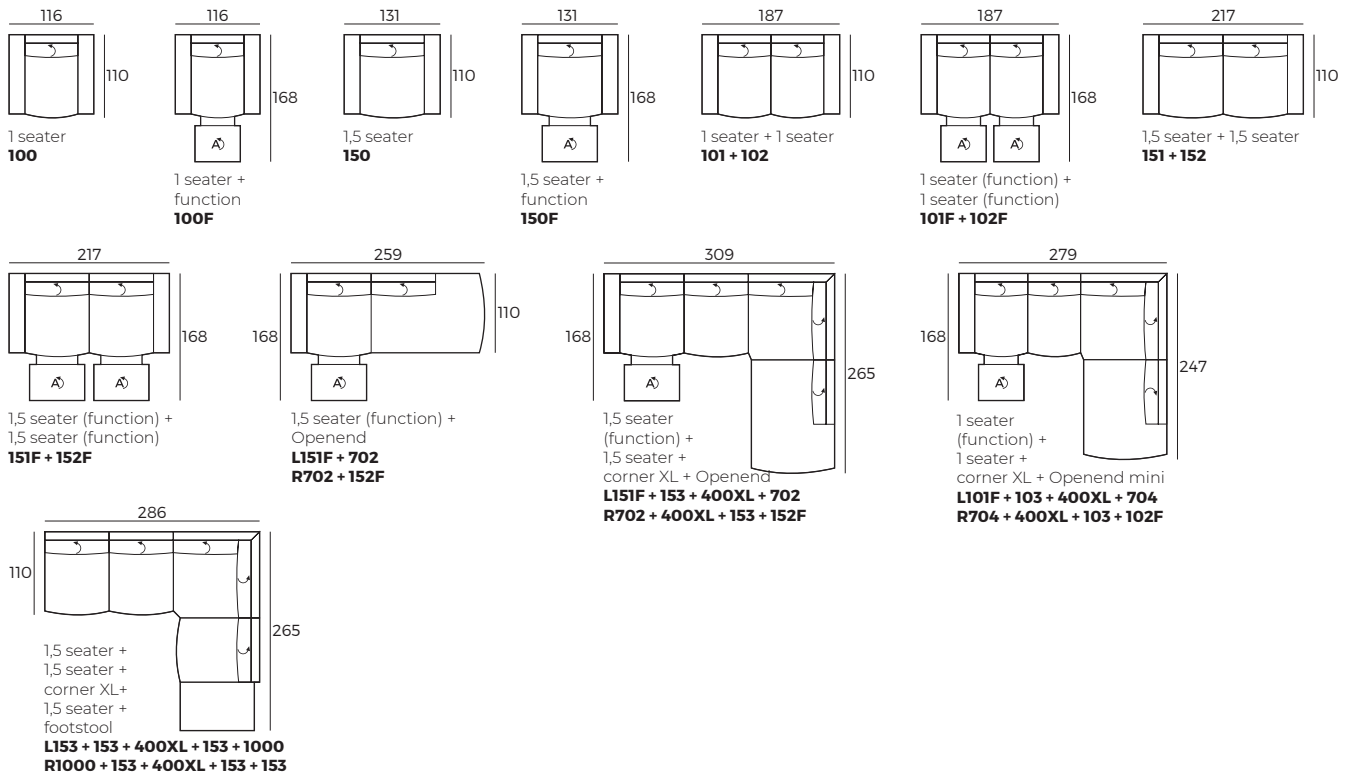

Accessories

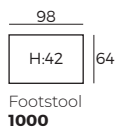

↶ - manual; ⚡ - electrical *F - single electric function

Largo



Largo



Comfort

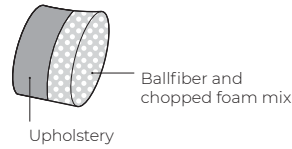
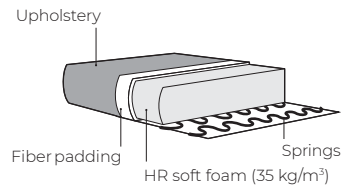

1. Upholstery



Leather*

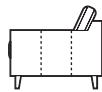

Fabric

* Leather covers may require more stitches than fabric covers.

2. Multicolor Option



Color A
Color B
Color C

3. Choose pillows



Pillow B



Pillow P

4. Legs



IMPORTANT:

Upholstered furniture is handmade using soft materials therefore measurements may vary up to +/- 5 cm.
Parts and sets shown in 2D drawings are left-sided. Parts and sets can be mirrored from left to right.

Single parts

Scale 1:100

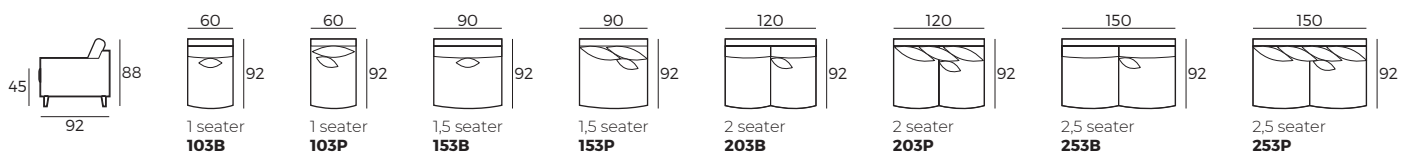

CUSTOM MADE COMFORT

Largo

Scale 1:100

Single parts

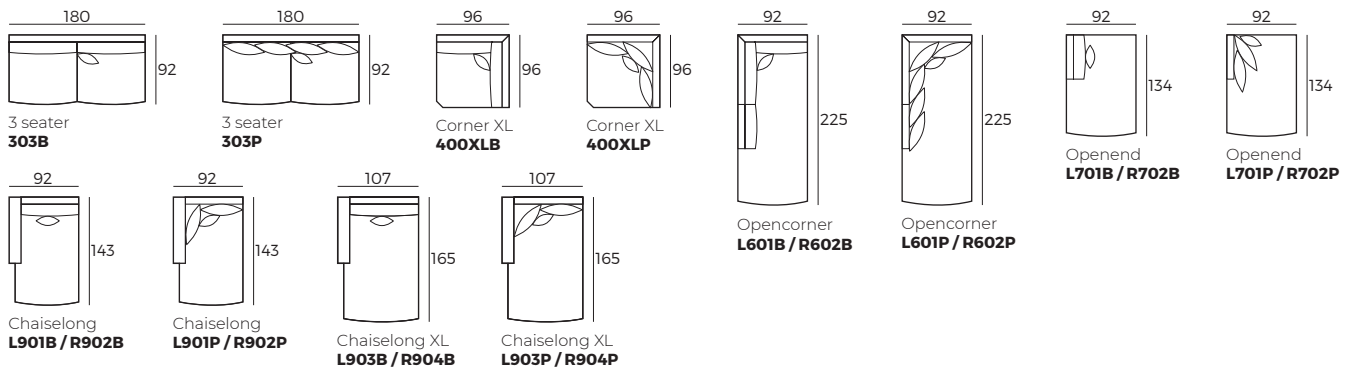

Half sets

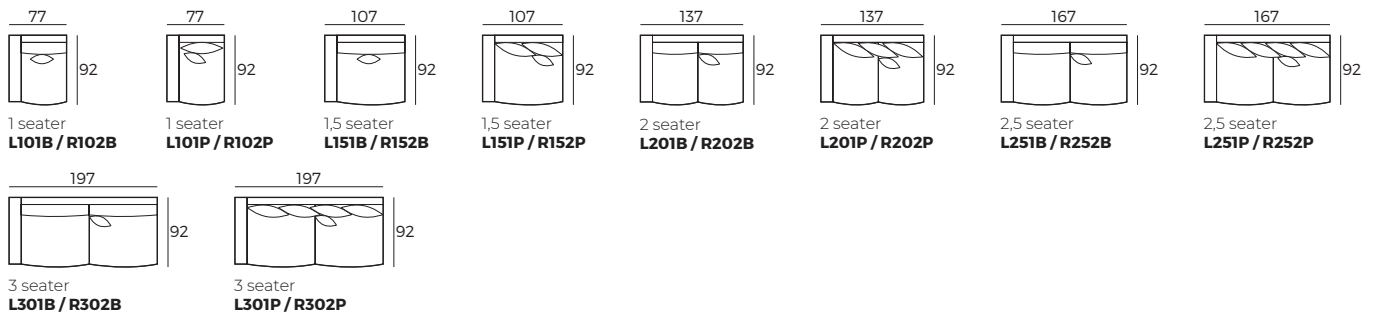

Sets

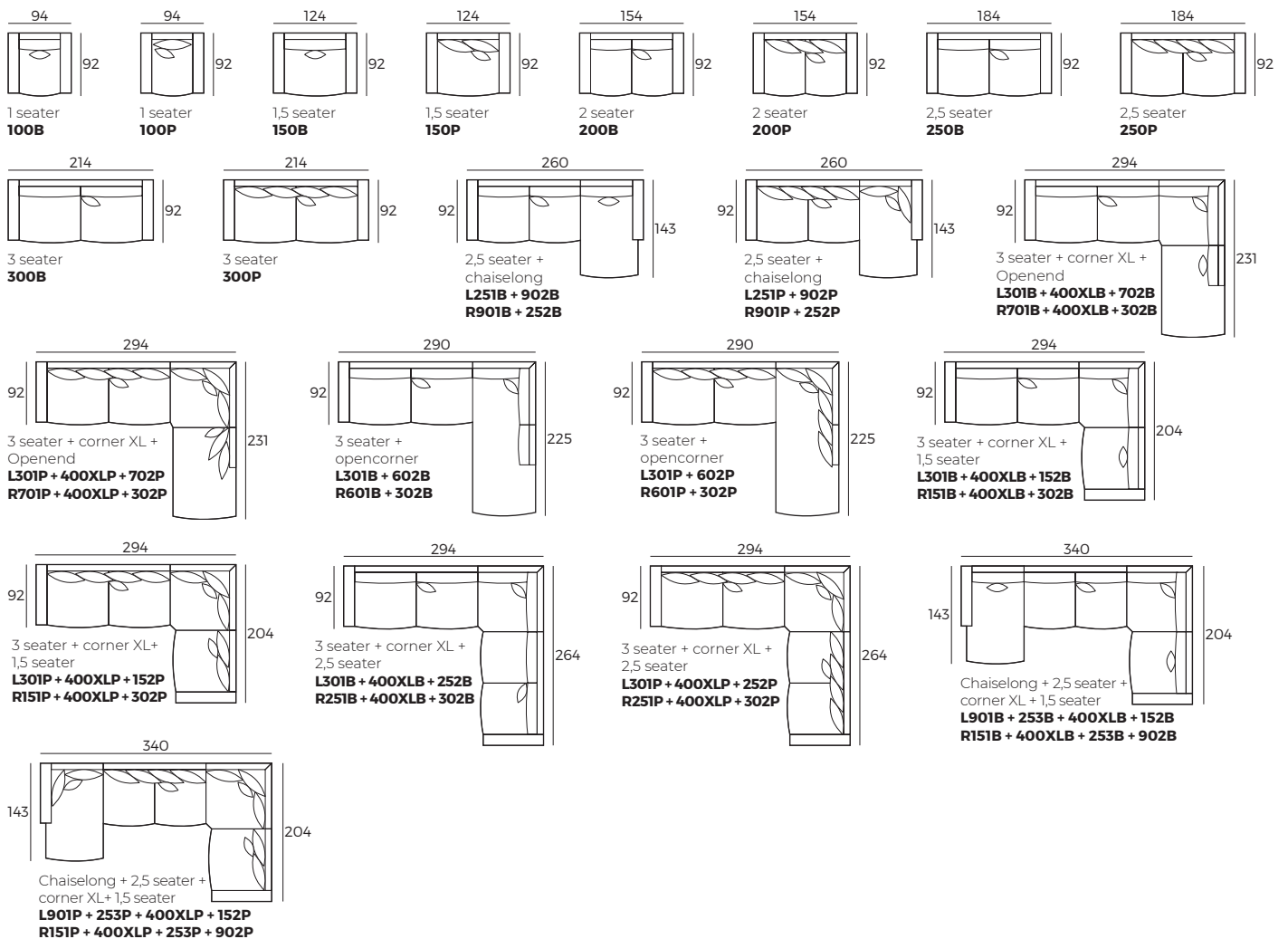

Largo

Accessories

Scale 1:100

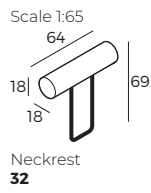
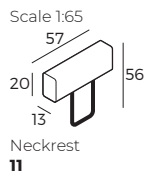
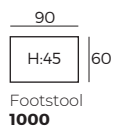

Larvik



Larvik



Comfort

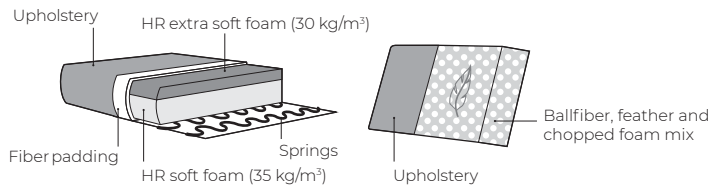

1. Upholstery



Fabric

2. Armrests



Blow
W 32 x D 105 x H 56



Street
W 25 x D 105 x H 56



Bento
W 21 x D 105 x H 56

3. Legs



441
Black colored
lacquer



White
oiled



340
Black colored
lacquer

IMPORTANT:

Upholstered furniture is handmade using soft materials therefore measurements may vary up to +/- 5 cm.
Parts and sets shown in 2D drawings are left-sided. Parts and sets can be mirrored from left to right.

Single parts (Measurements with Street armrest)

Scale 1:100

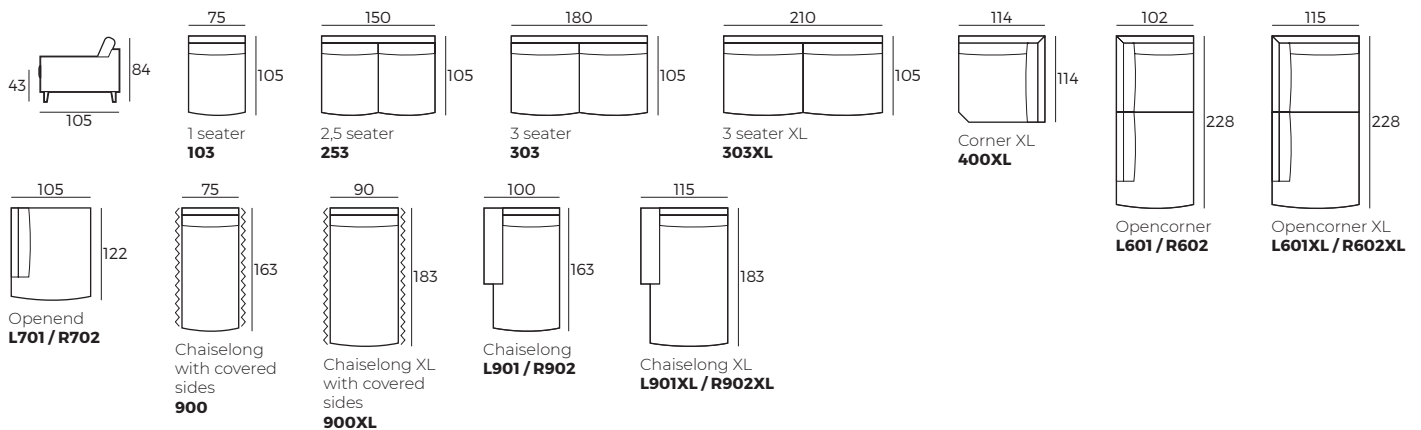

Larvik

Half sets (Measurements with Street armrest)

Scale 1:100

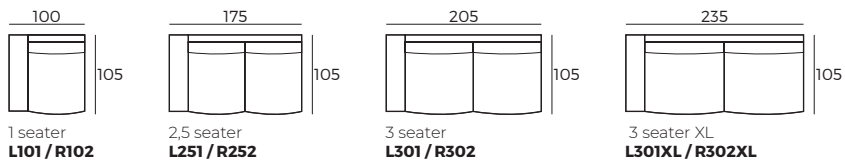

Sets (Measurements with Street armrest)

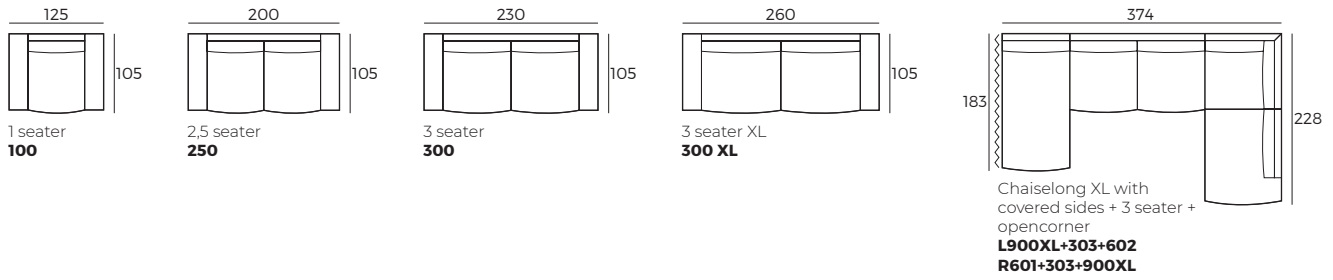

Accessories

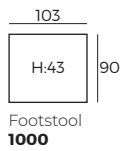

Laure



Laure



Comfort

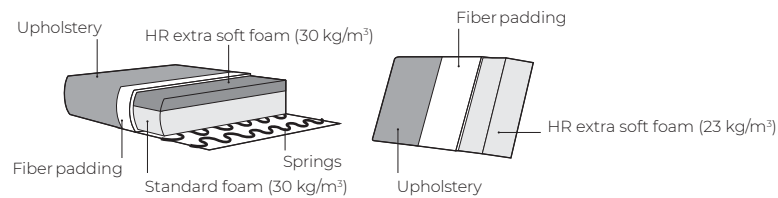

1. Upholstery



* Leather covers may require more stitches than fabric covers.

2. Headrest & seat type

*Measures with fully opened mechanism

- 1 Manual ↶ / Electrical ↷
- 2 Electrical ↷

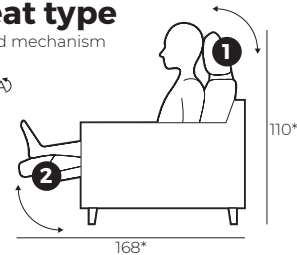

3. Bi-Color option

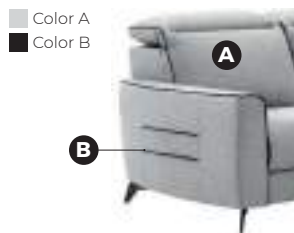

4. Legs



IMPORTANT:

Upholstered furniture is handmade using soft materials therefore measurements may vary up to +/- 5 cm.
Parts and sets shown in 2D drawings are left-sided. Parts and sets can be mirrored from left to right.

Single parts

Scale 1:100

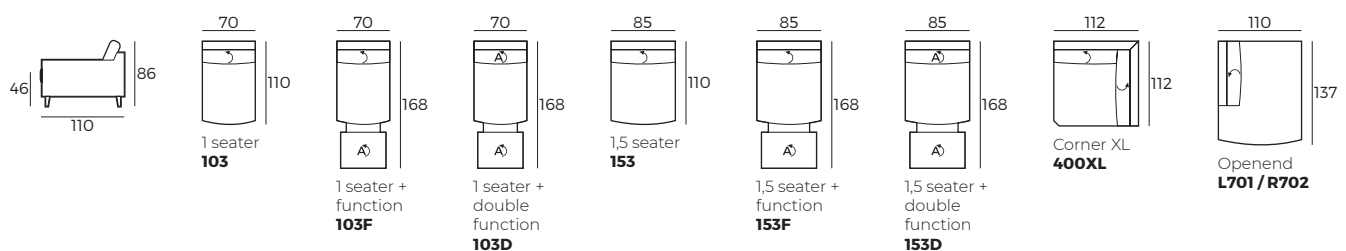

CUSTOM MADE COMFORT

Laure

Scale 1:100

Single parts

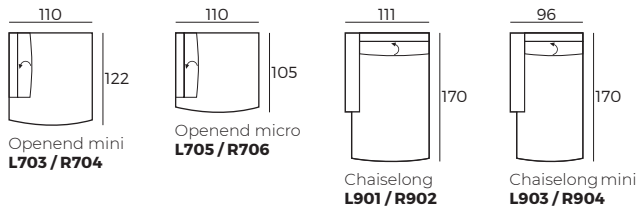

Half sets

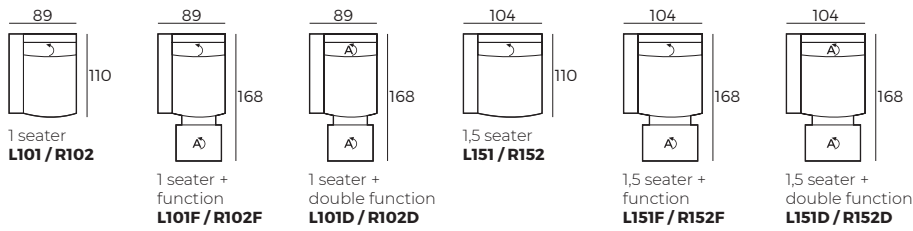

Sets

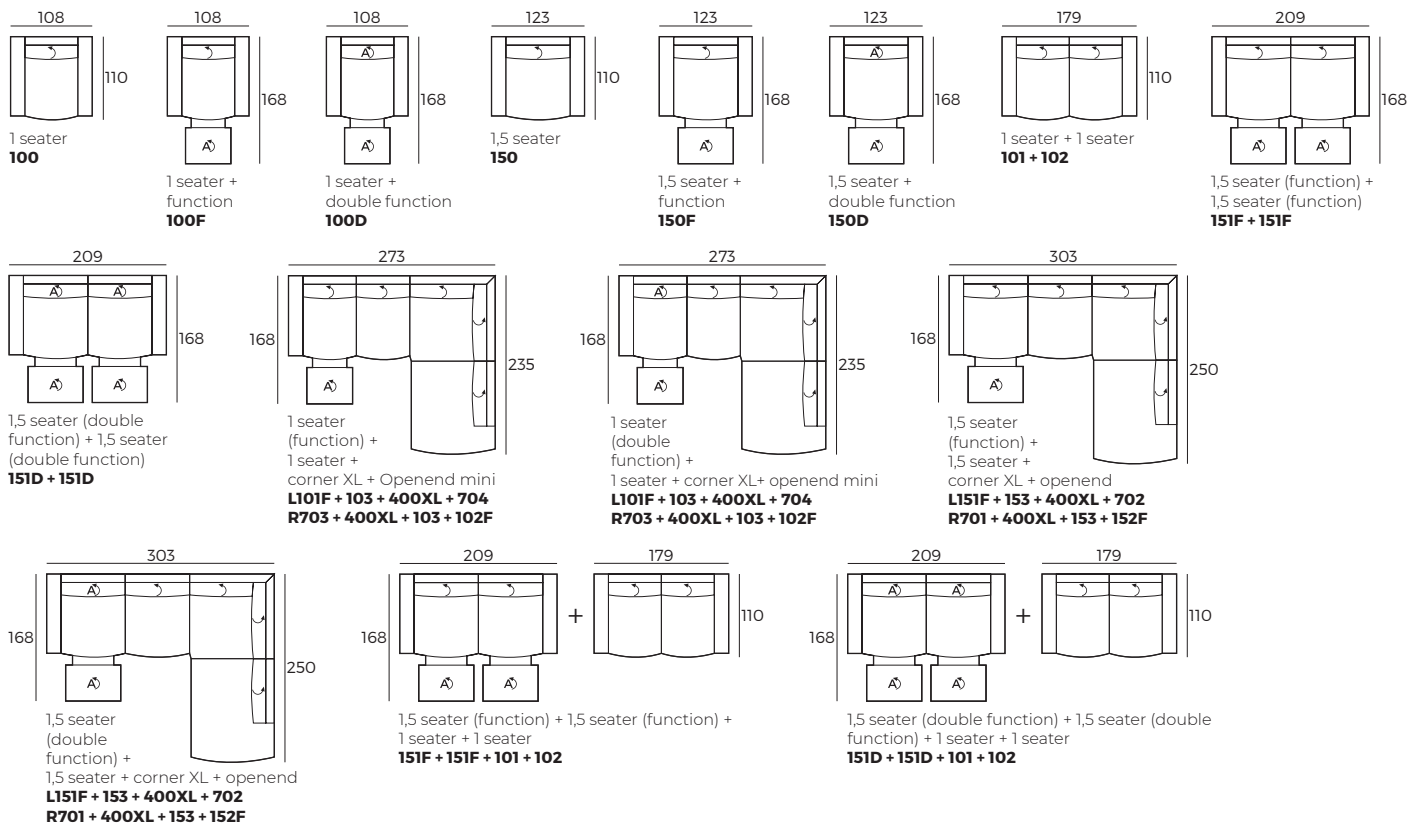

Accessories

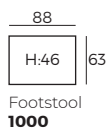

↶ - manual; ↷ - electrical *F - single electric function; *D - double electric function

Lavar



Lavar



Comfort

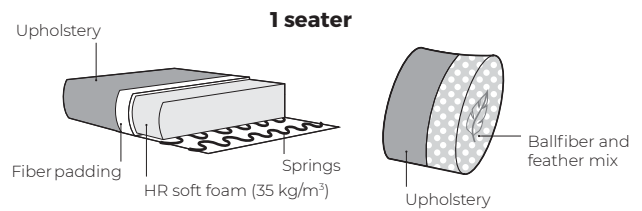
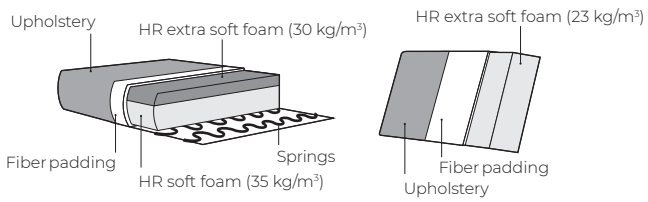

1. Upholstery



Fabric

2. Legs

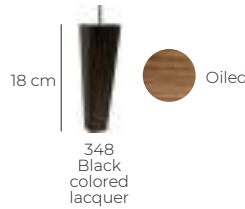

IMPORTANT:

Upholstered furniture is handmade using soft materials therefore measurements may vary up to +/- 5 cm.
Parts and sets shown in 2D drawings are left-sided. Parts and sets can be mirrored from left to right.

Single parts

Scale 1:100

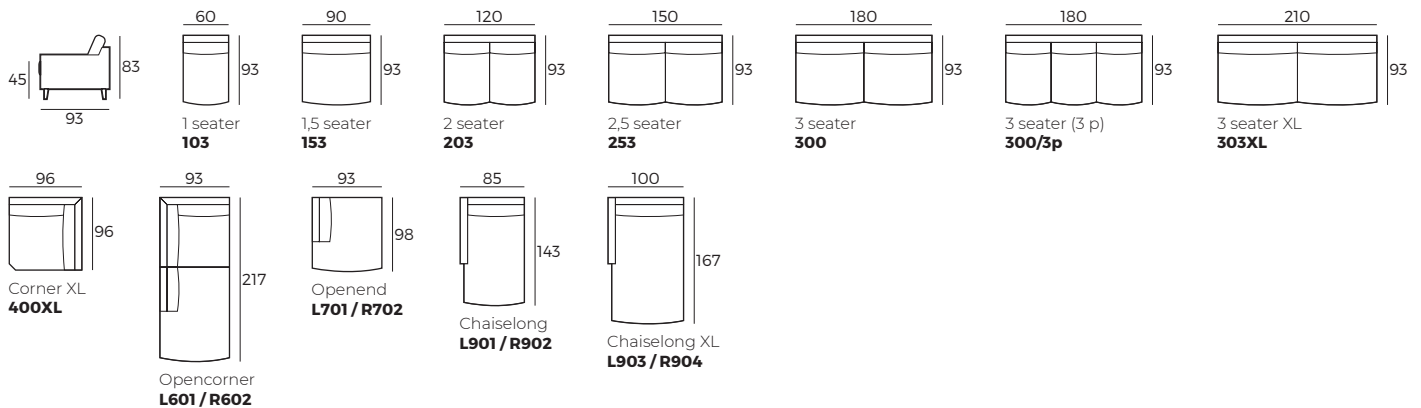

Lavar

Scale 1:100

Half sets

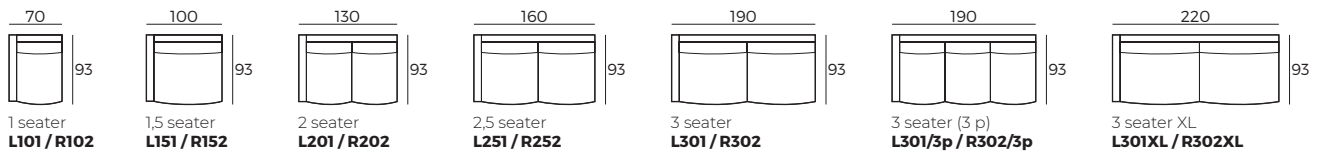

Sets

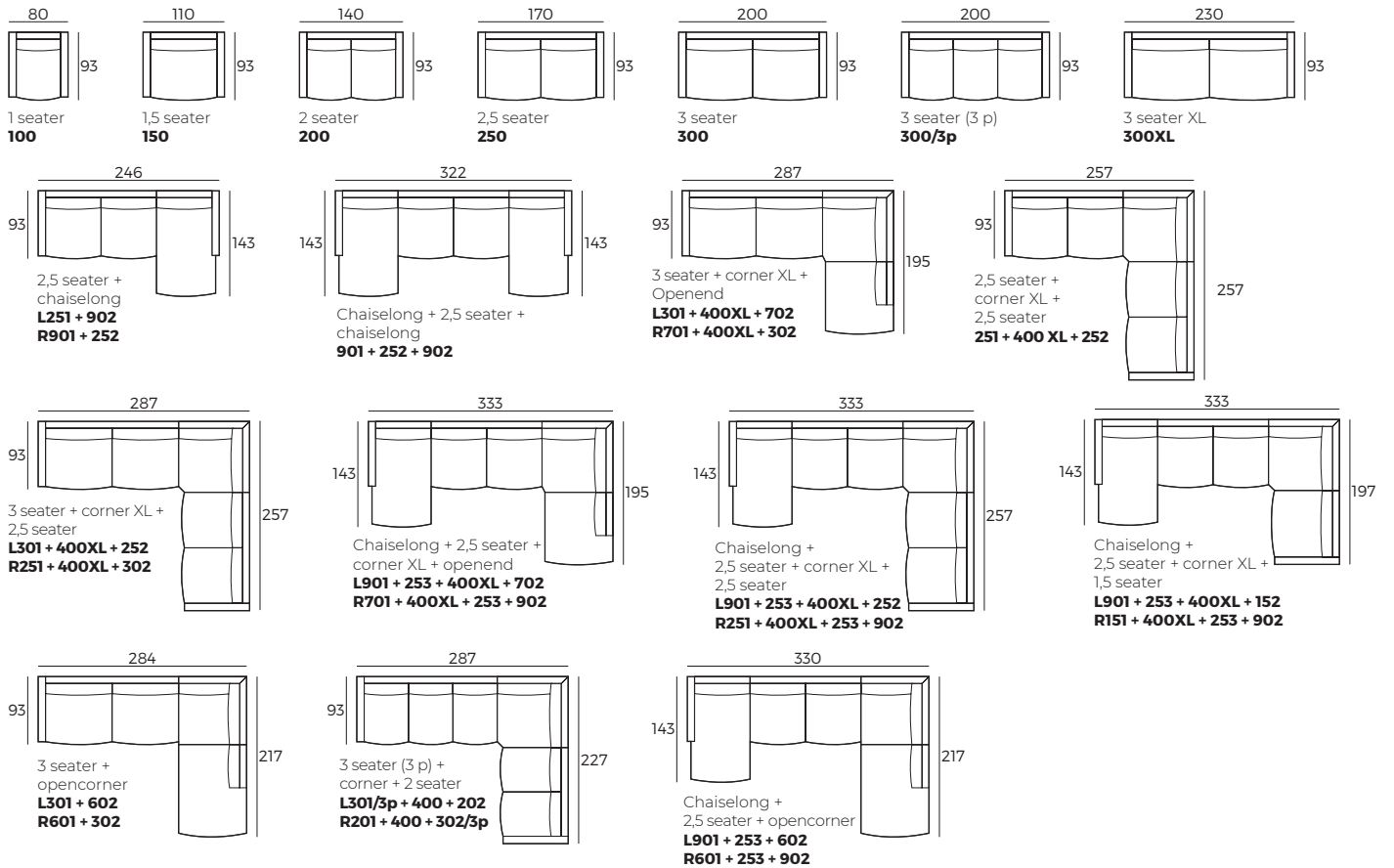

Accessories

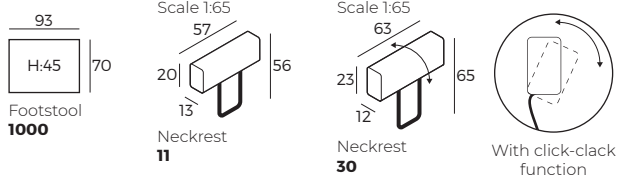

Lavina



Lavina



Comfort

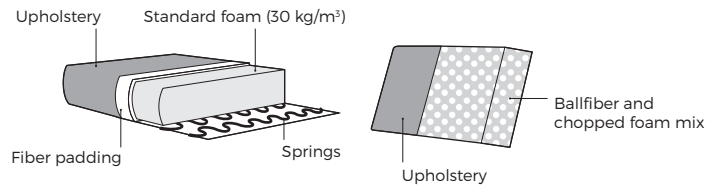

1. Upholstery

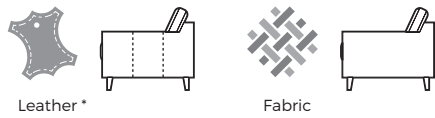

* Leather covers may require more stitches than fabric covers.

2. Legs



IMPORTANT:

Upholstered furniture is handmade using soft materials therefore measurements may vary up to **+/- 5 cm**.
Parts and sets shown in 2D drawings are left-sided. Parts and sets can be mirrored from left to right.

Single parts

Scale 1:100

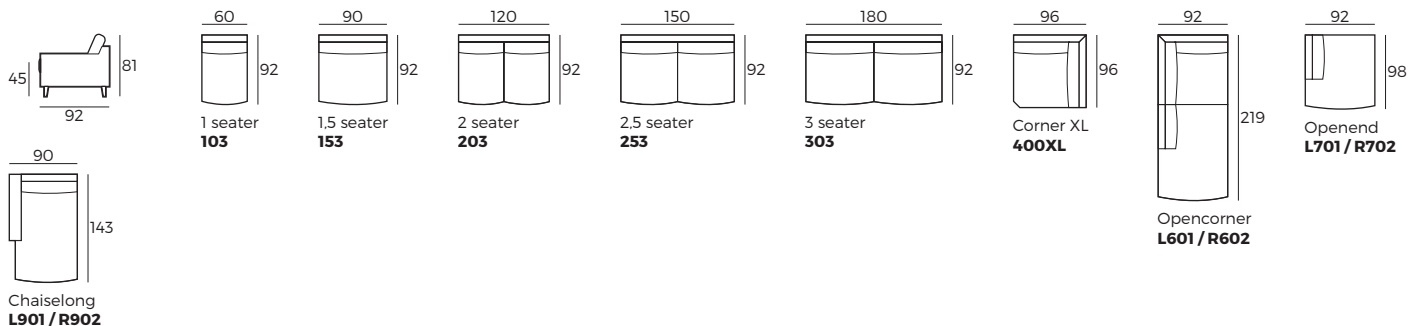

Half sets

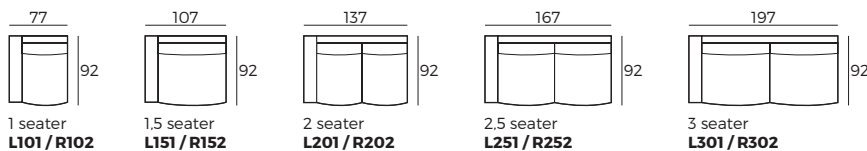

CUSTOM MADE COMFORT

Lavina

Sets

Scale 1:100

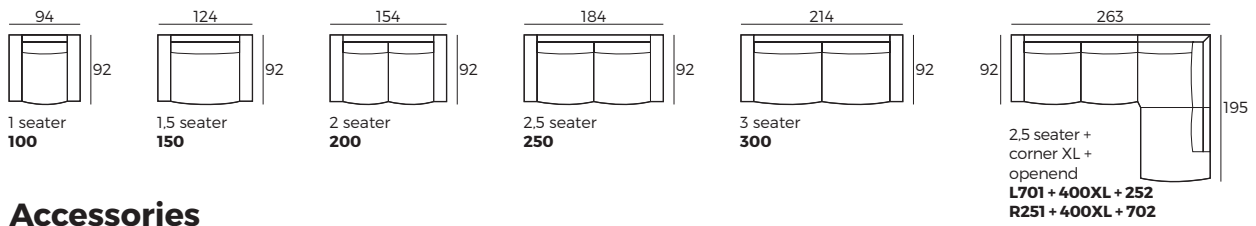

Accessories

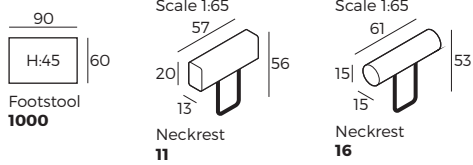

Lean



Lean



Comfort

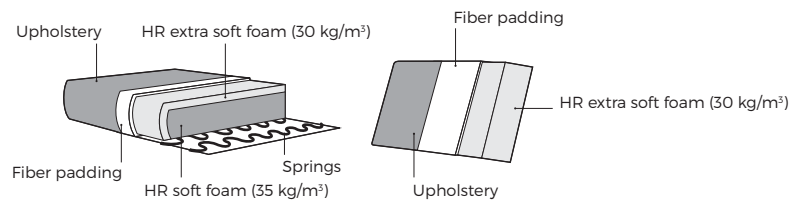

1. Upholstery

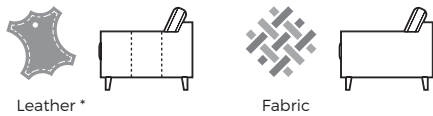

* Leather covers may require more stitches than fabric covers.

2. Legs



IMPORTANT:

Upholstered furniture is handmade using soft materials therefore measurements may vary up to +/- 5 cm.
Parts and sets shown in 2D drawings are left-sided. Parts and sets can be mirrored from left to right.

Single parts

Scale 1:100

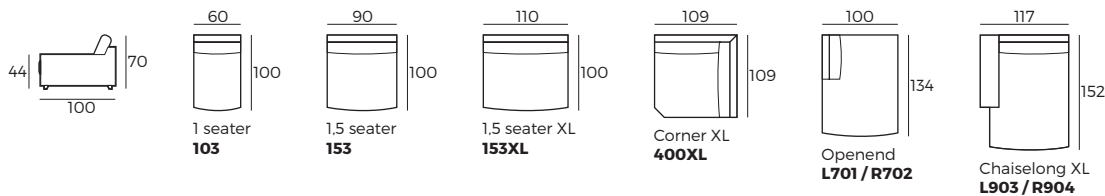

Half sets

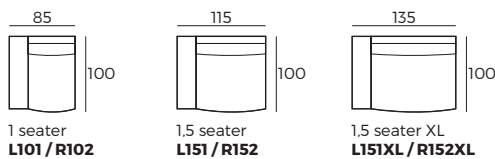

Lean

Sets

Scale 1:100

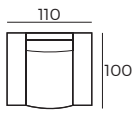

1 seater
100

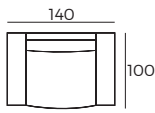

1,5 seater
150

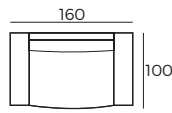

1,5 seater XL
150XL

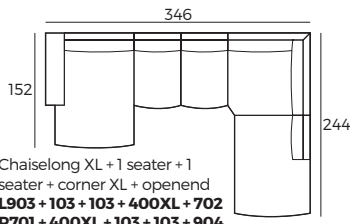

Chaiselong XL + 1 seater + 1 seater + corner XL + openend
L903 + 103 + 103 + 400XL + 702
R701 + 400XL + 103 + 103 + 904

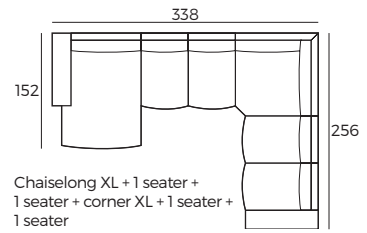

Chaiselong XL + 1 seater + 1 seater + corner XL + 1 seater + 1 seater
L903 + 103 + 103 + 400XL + 103 + 102
R101 + 103 + 400XL + 103 + 103 + 904

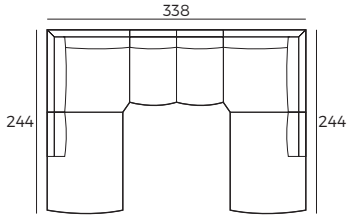

Openend + corner + 1 seater + 1 seater + corner XL + openend
701 + 400XL + 103 + 103 + 400XL + 702

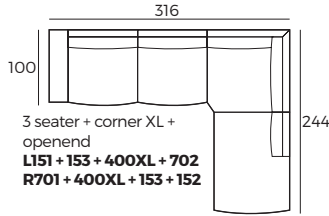

3 seater + corner XL + openend
L151 + 153 + 400XL + 702
R701 + 400XL + 153 + 152

Accessories

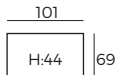

Footstool
1000

Leny



Leny



Comfort

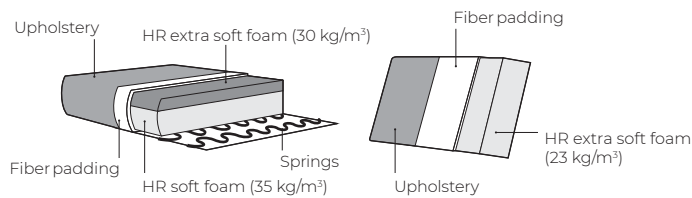

1. Upholstery



* Leather covers may require more stitches than fabric covers.

2. Headrest & seat type

*Measures with fully opened mechanism

- 1 Manual ↻
- 2 Electrical ⏻

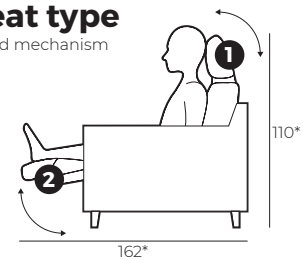

3. Armrest

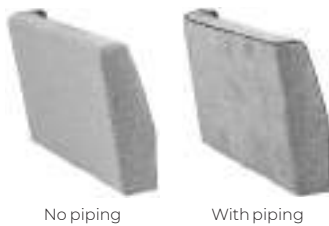

4. Bi-Color option

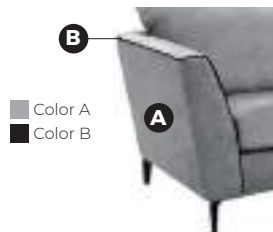

5. Legs



IMPORTANT:

Upholstered furniture is handmade using soft materials therefore measurements may vary up to +/- 5 cm.
Parts and sets shown in 2D drawings are left-sided. Parts and sets can be mirrored from left to right.

Single parts

Scale 1:100

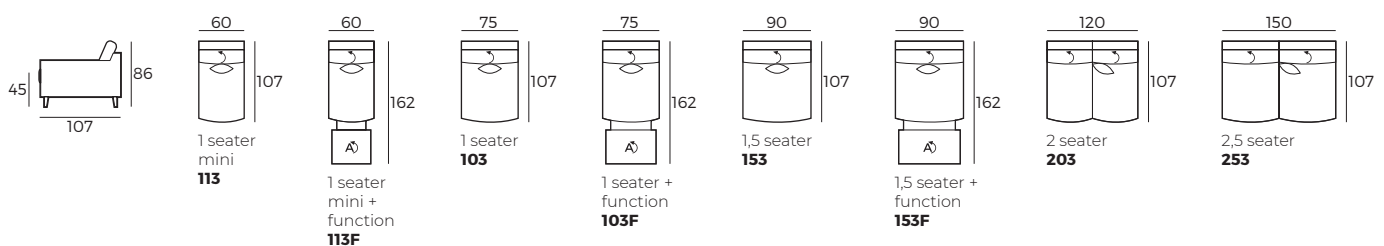

CUSTOM MADE COMFORT

Leny

Scale 1:100

Single parts

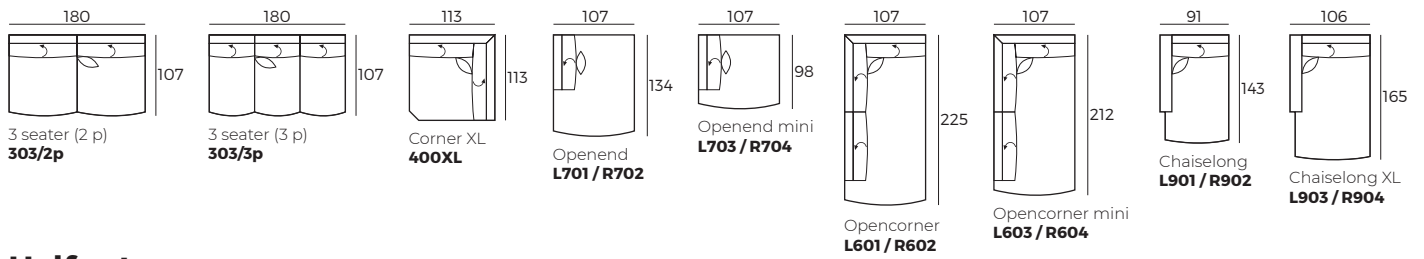

Half sets

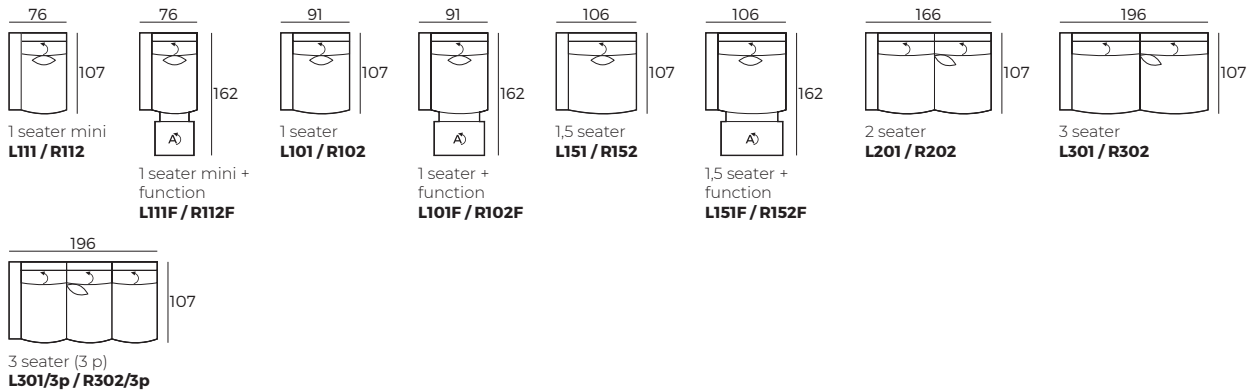

Sets

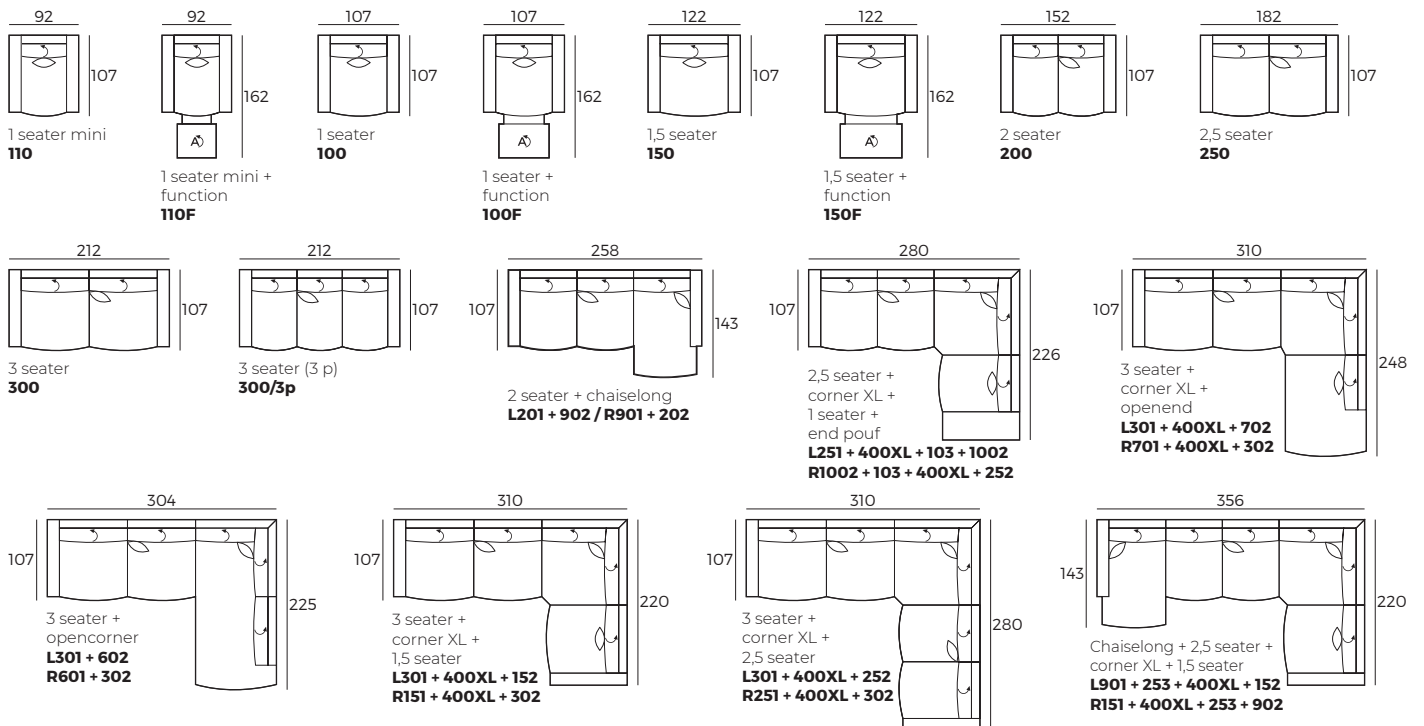

Accessories

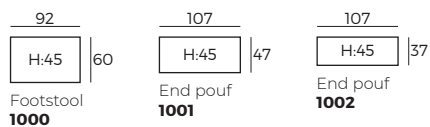

↷ - manual; ⚡ - electrical *F - single electric function

Libre

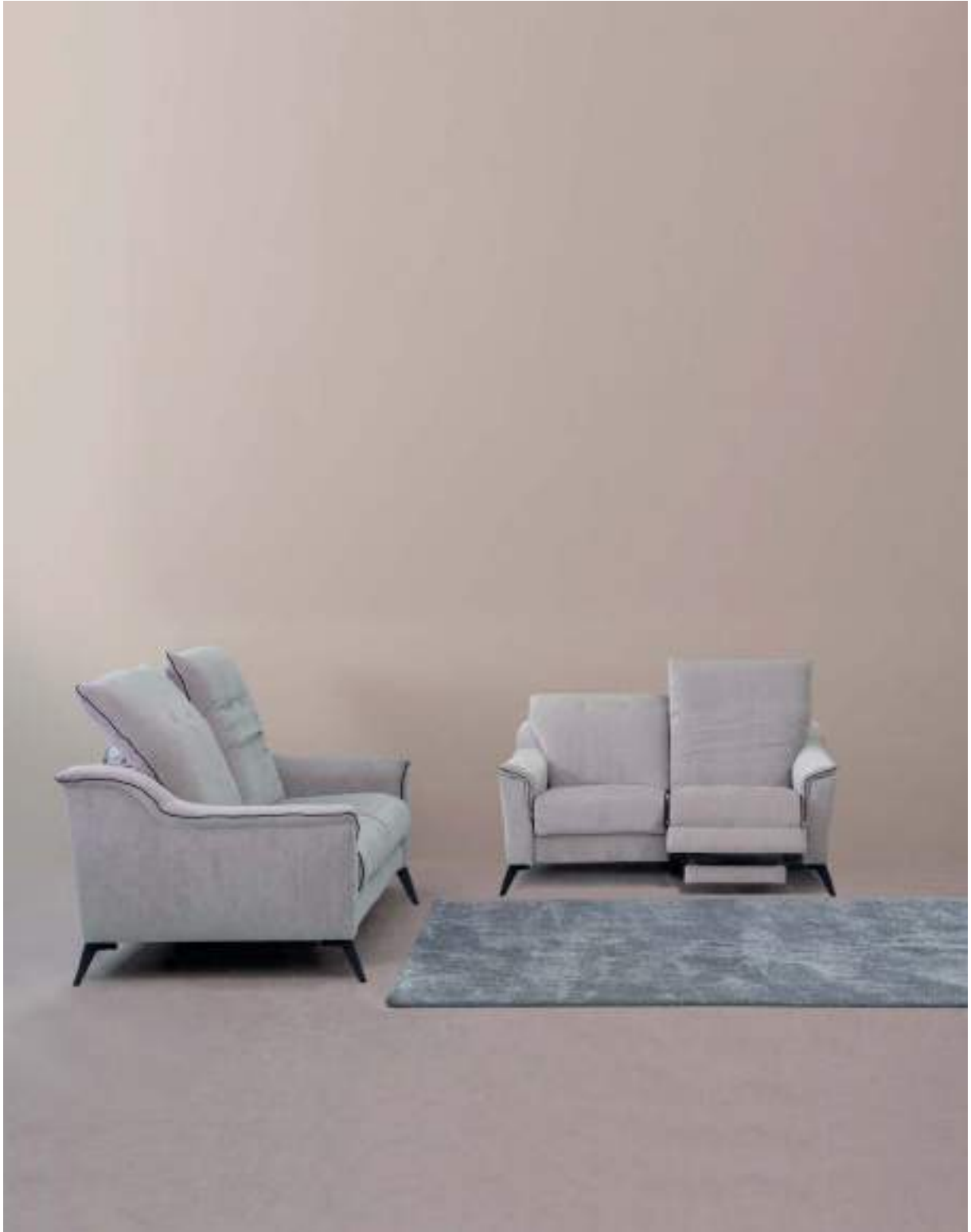

Libre



Comfort

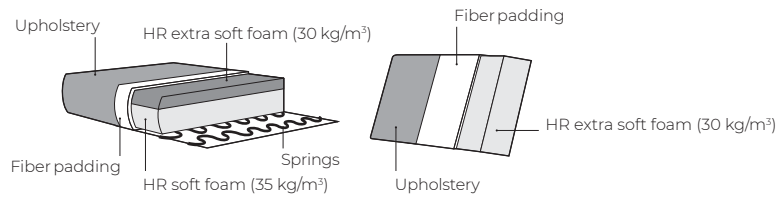

1. Upholstery



* Leather covers may require more stitches than fabric covers.

2. Headrest & seat type

*Measures with fully opened mechanism

- 1 Manual ↷
- 2 Electrical ↻

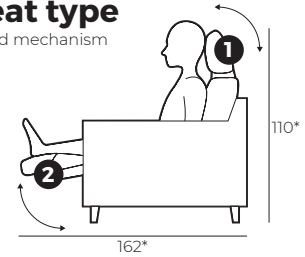

3. Bi-Color option

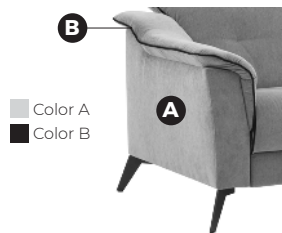

4. Legs



IMPORTANT:

Upholstered furniture is handmade using soft materials therefore measurements may vary up to +/- 5 cm.
Parts and sets shown in 2D drawings are left-sided. Parts and sets can be mirrored from left to right.

Single parts

Scale 1:100

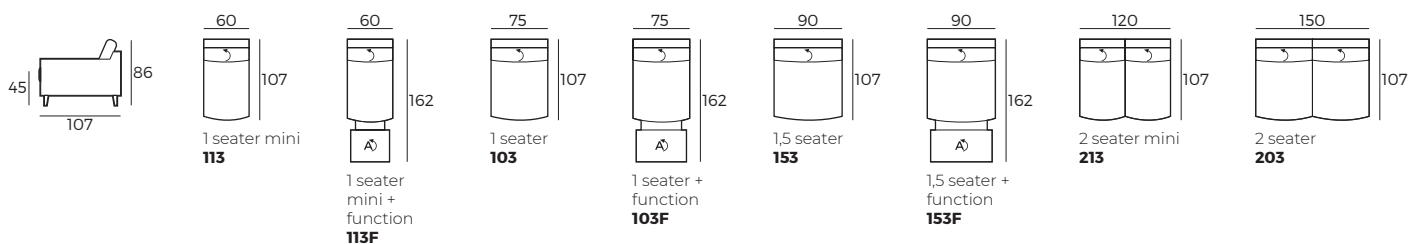

CUSTOM MADE COMFORT

Libre

Scale 1:100

Single parts

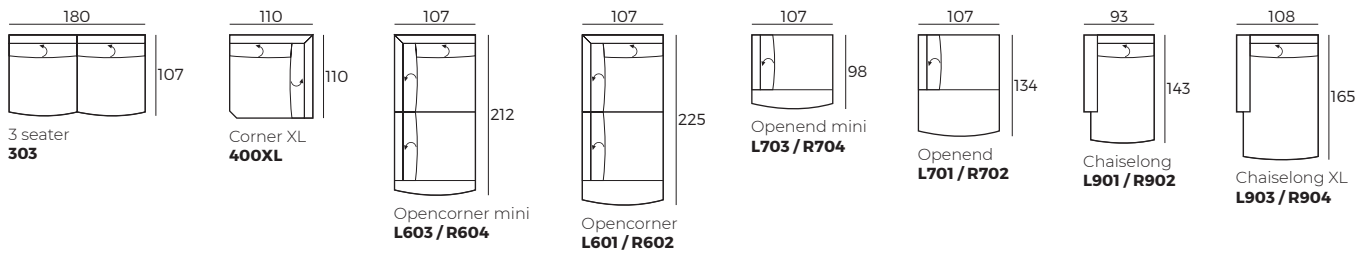

Half sets

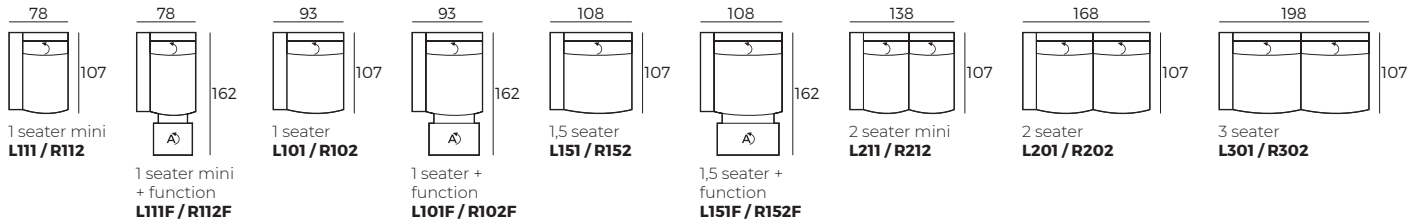

Sets

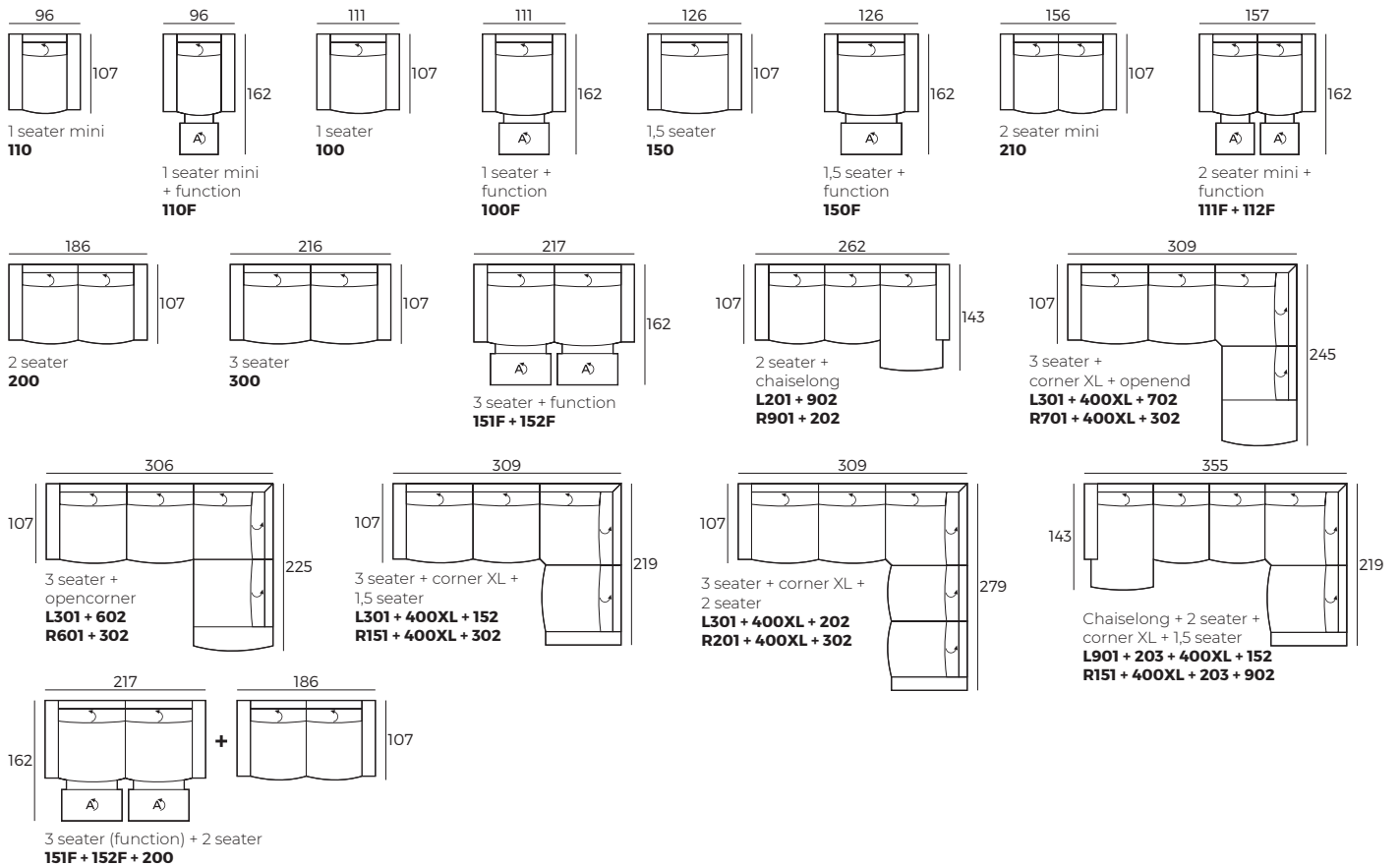

Accessories

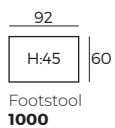

↶ - manual; ↷ - electrical *F - single electric function

Linus



Linus



Comfort

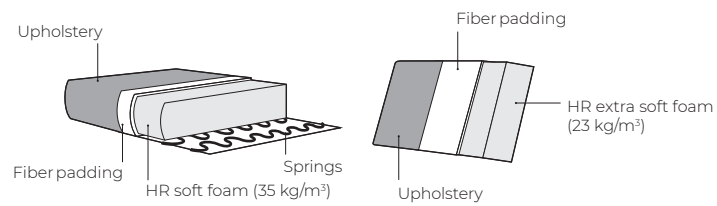

1. Upholstery



* Leather covers may require more stitches than fabric covers.

2. Legs



IMPORTANT:

Upholstered furniture is handmade using soft materials therefore measurements may vary up to +/- 5 cm.
Parts and sets shown in 2D drawings are left-sided. Parts and sets can be mirrored from left to right.

Sets

Scale 1:100

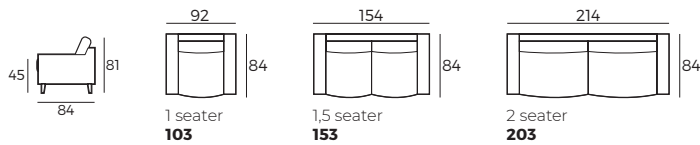

Lita

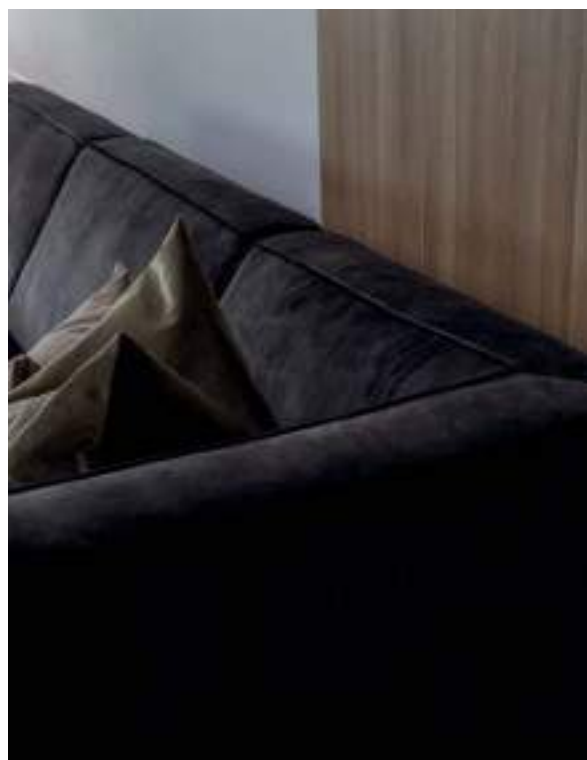

Lita



Comfort

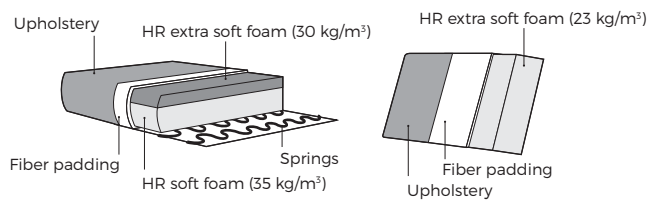

1. Upholstery



Fabric

2. Legs



385
Black metal

IMPORTANT:

Upholstered furniture is handmade using soft materials therefore measurements may vary up to +/- 5 cm.
Parts and sets shown in 2D drawings are left-sided. Parts and sets can be mirrored from left to right.

Single parts

Scale 1:100

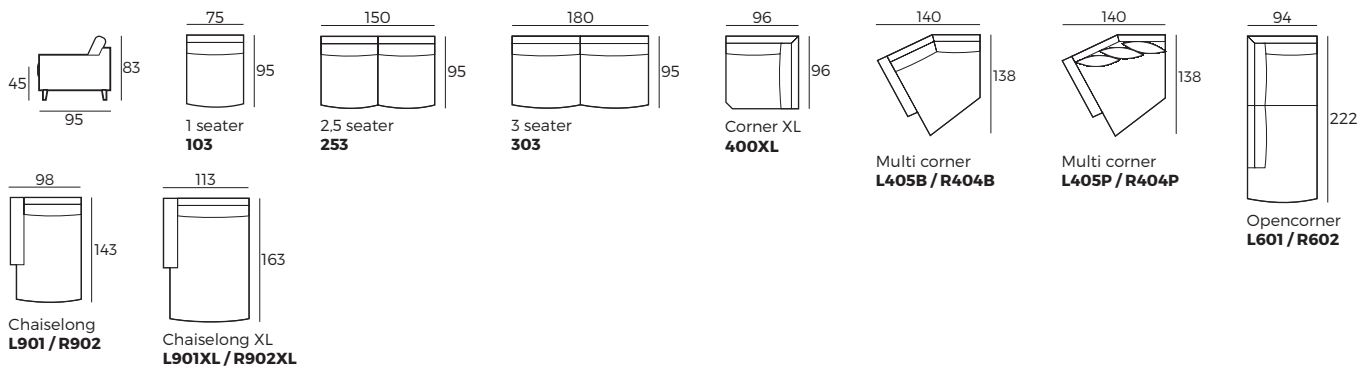

Half sets

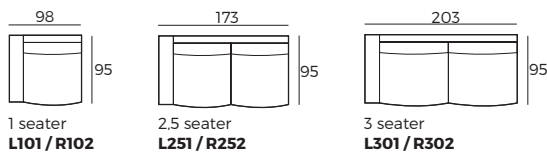

Sets

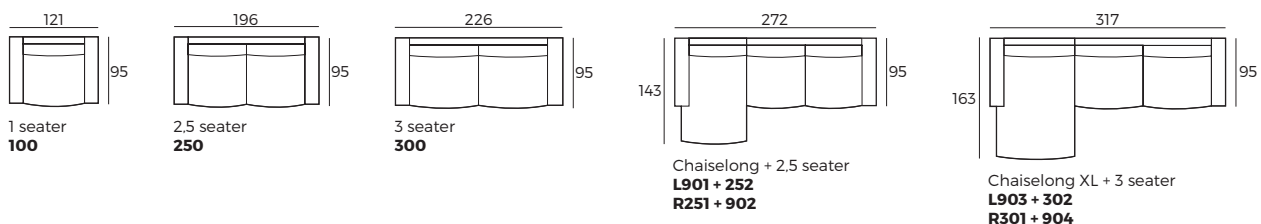

Lita

Sets

Scale 1:100

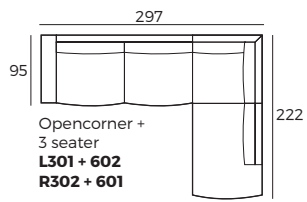

Accessories

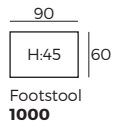

Live



Live



Comfort

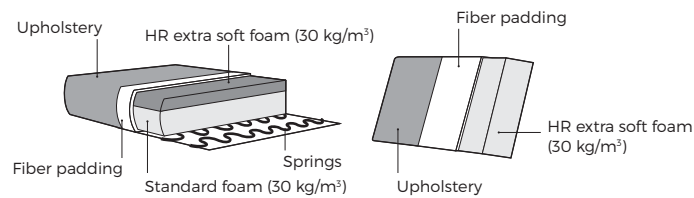

1. Upholstery

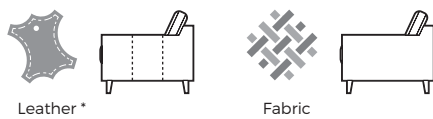

* Leather covers may require more stitches than fabric covers.

2. Headrest & seat type

*Measures with fully opened mechanism

- ① Manual ↗ / Electrical ⚡
- ② Electrical ⚡

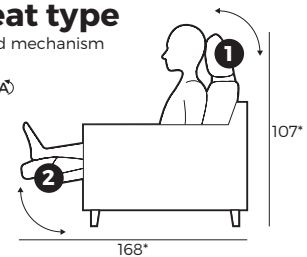

3. Bi-Color option

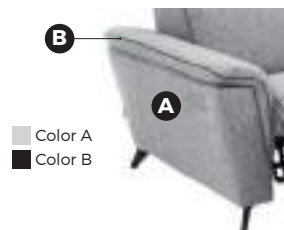

4. Legs



IMPORTANT:

Upholstered furniture is handmade using soft materials therefore measurements may vary up to +/- 5 cm.
Parts and sets shown in 2D drawings are left-sided. Parts and sets can be mirrored from left to right.

Single parts

Scale 1:100

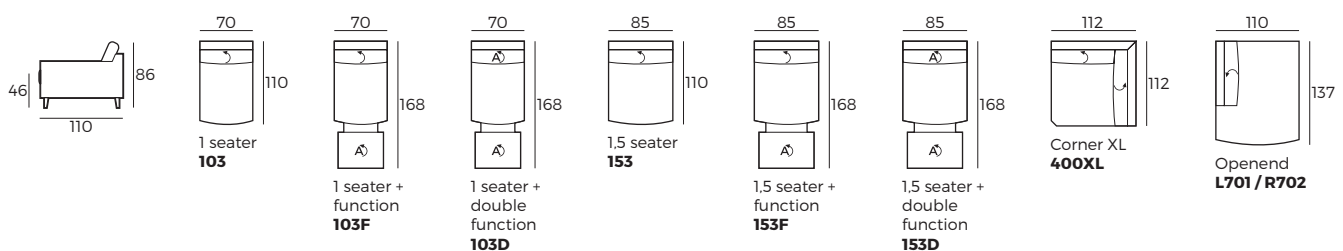

CUSTOM MADE COMFORT

Live

Scale 1:100

Single parts

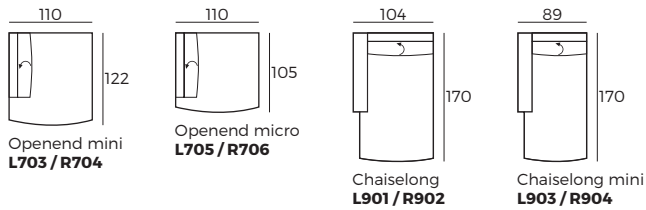

Half sets

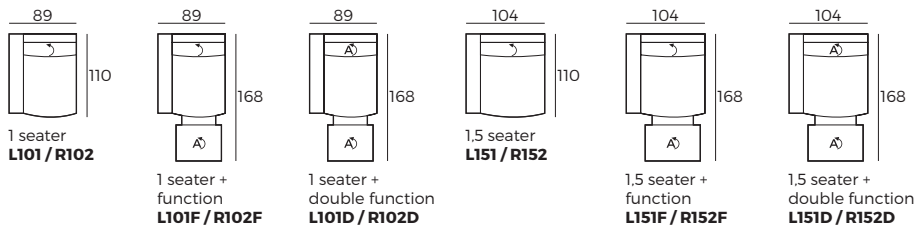

Sets

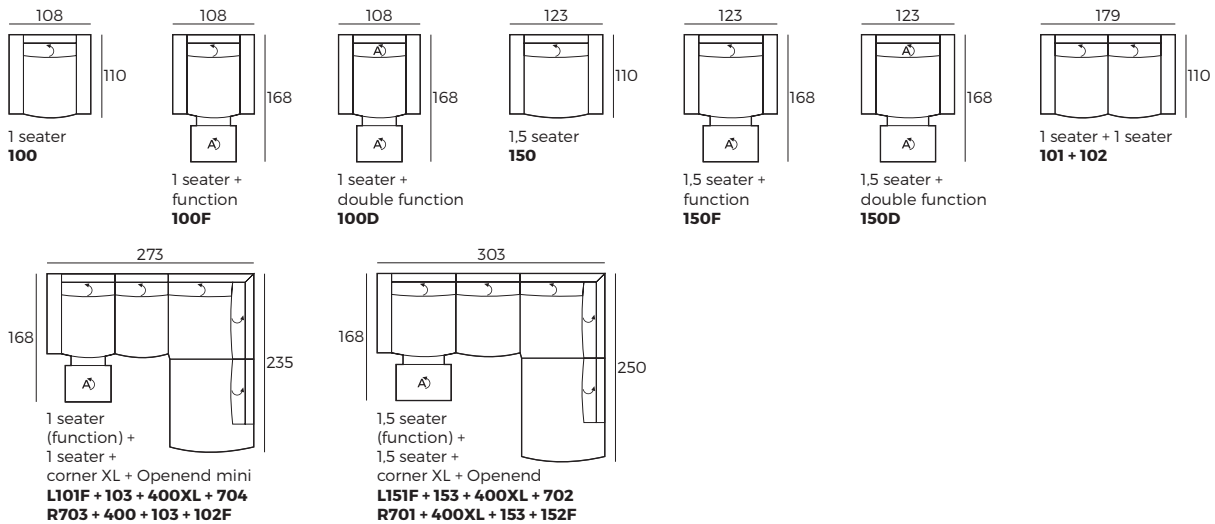

Accessories

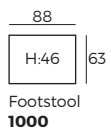

› - manual; Ⓐ - electrical *F - single electric function; *D - double electric function

Livingston



Livingston



Comfort selection

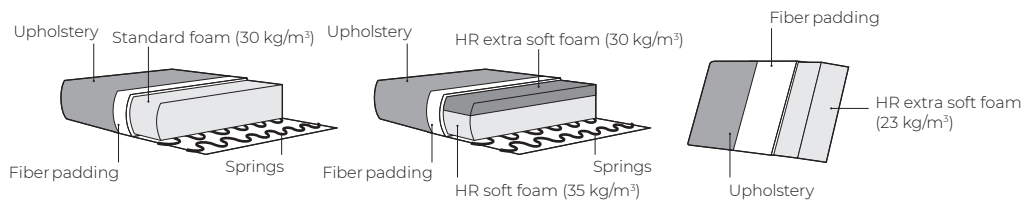

1. Upholstery



Leather*

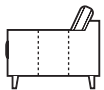

Fabric

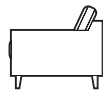

* Leather covers may require more stitches than fabric covers.

2. Armrests



1

W 23 x D 91 x H 52



2

W 31 x D 91 x H 38



3

W 16 x D 91 x H 45

Armrest 2 function



3. Legs



IMPORTANT:

Upholstered furniture is handmade using soft materials therefore measurements may vary up to **+/- 5 cm**.
Parts and sets shown in 2D drawings are left-sided. Parts and sets can be mirrored from left to right.

Single parts (Measurements with 2 armrest)

Scale 1:100

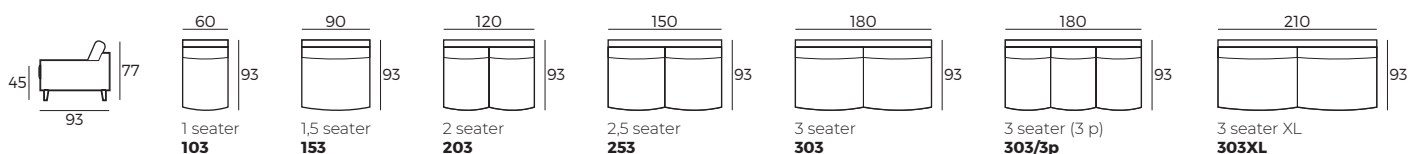

CUSTOM MADE COMFORT

Livingston

Single parts (Measurements with 2 armrest)

Scale 1:100

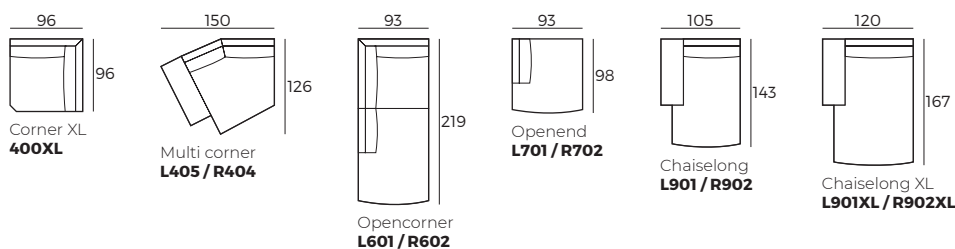

Half sets (Measurements with 2 armrest)

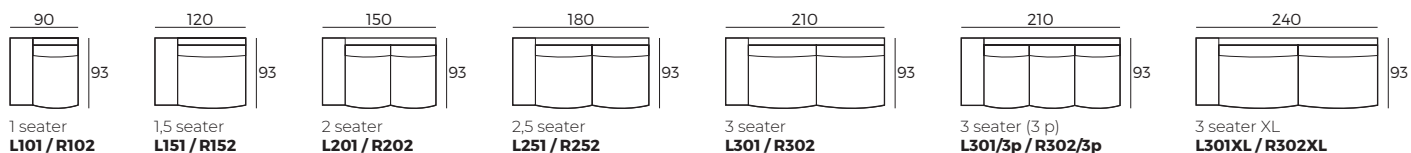

Sets (Measurements with 2 armrest)

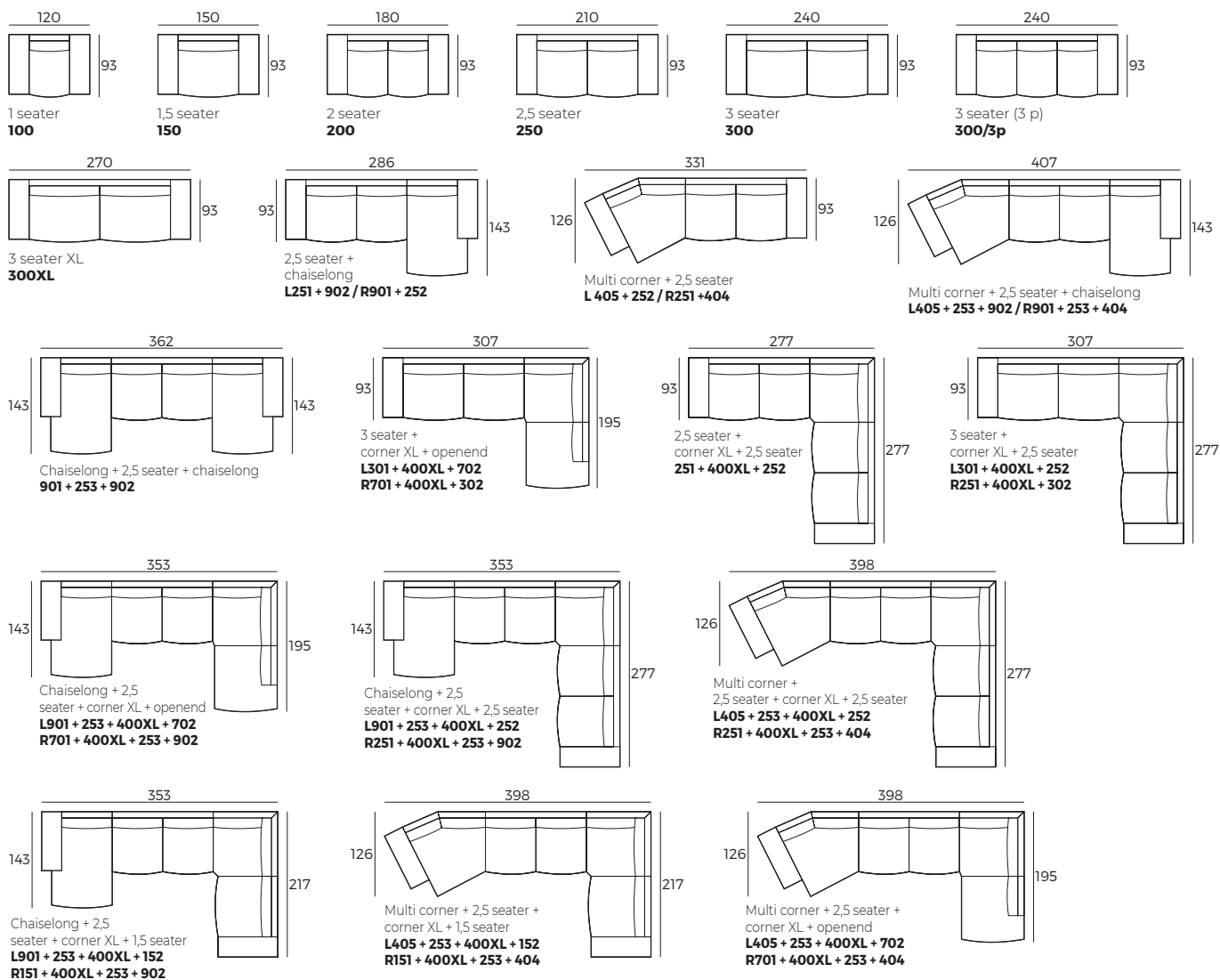

Livingston

Sets (Measurements with 2 armrest)

Scale 1:100

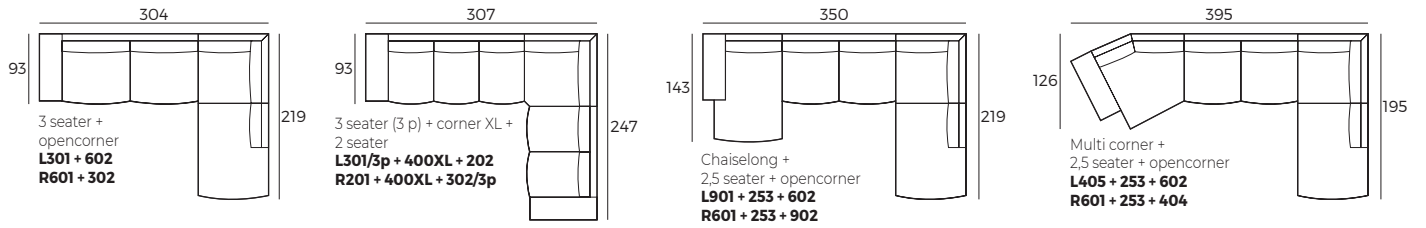

Accessories

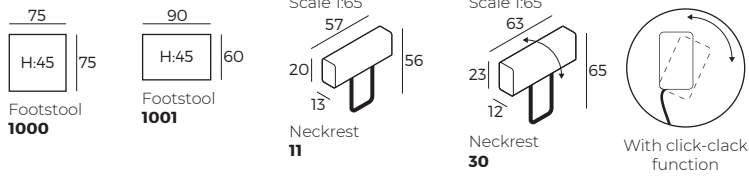

Liv



Liv



Comfort

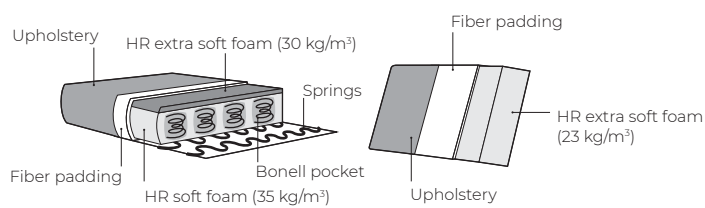

1. Upholstery



Leather*

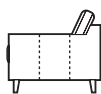

Fabric

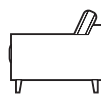

* Leather covers may require more stitches than fabric covers.

2. Armrest



Flexy

W 12/20 x D 90 x H 51



Share

W 16 x D 90 x H 48



Evy

W 18 x D 90 x H 52

3. Legs



230 Oiled



393 Black metal



387 Black metal

IMPORTANT:

Upholstered furniture is handmade using soft materials therefore measurements may vary up to **+/- 5 cm**.
Parts and sets shown in 2D drawings are left-sided. Parts and sets can be mirrored from left to right.

Single parts (Measurements with Share armrest)

Scale 1:100

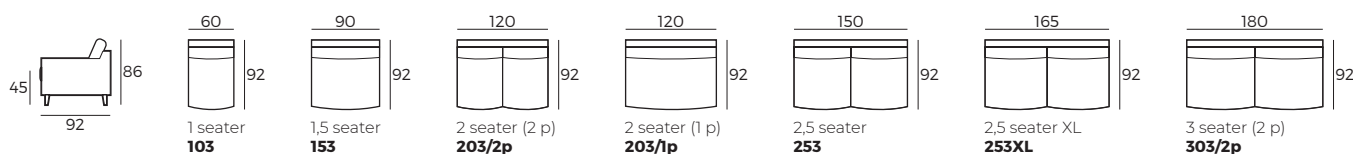

CUSTOM MADE COMFORT

Single parts (Measurements with Share armrest)

Scale 1:100

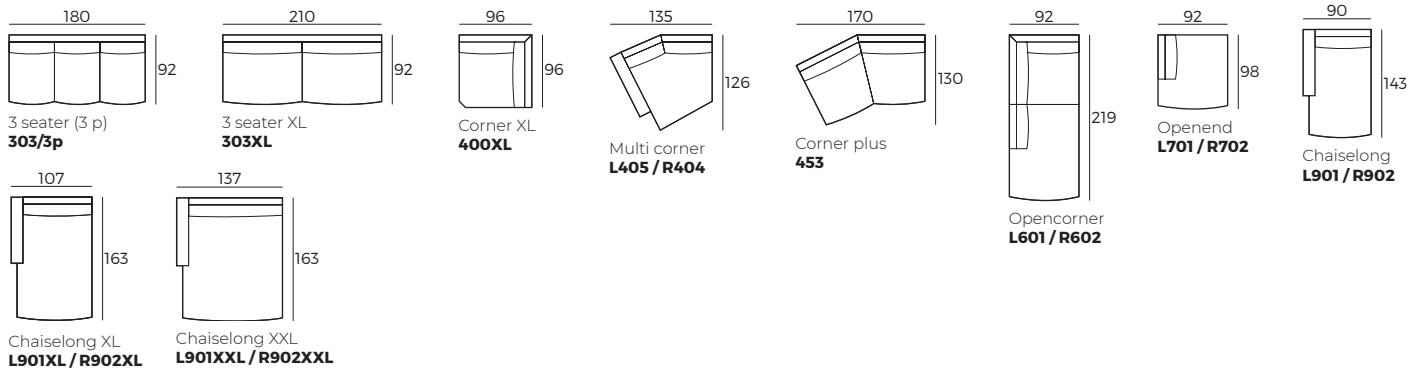

Half sets (Measurements with Share armrest)

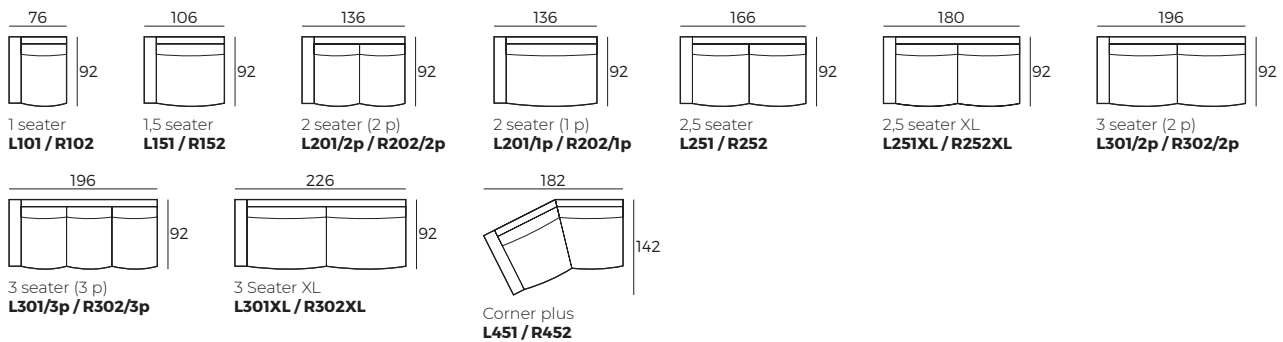

Sets (Measurements with Share armrest)

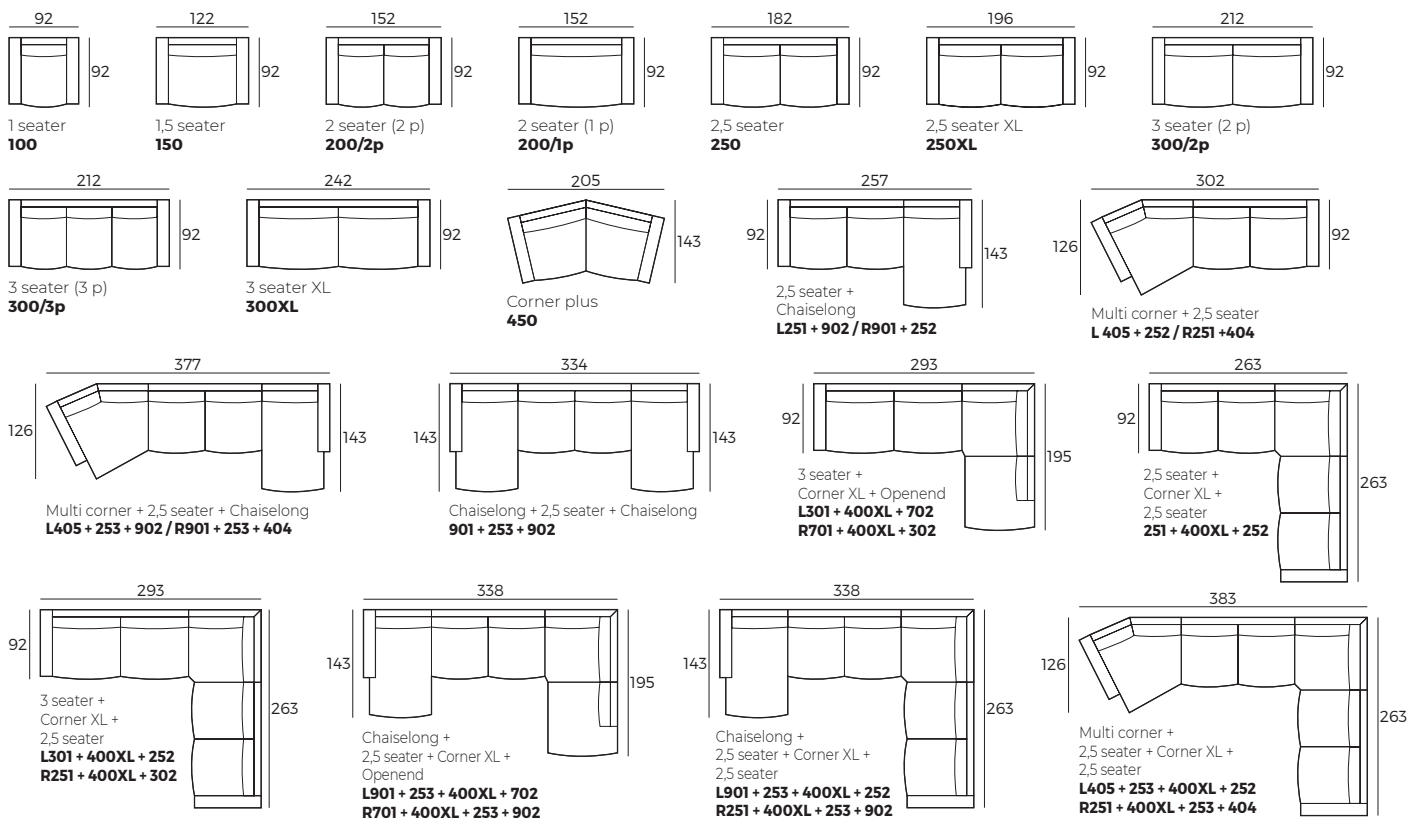

Liv

Sets (Measurements with Share armrest)

Scale 1:100

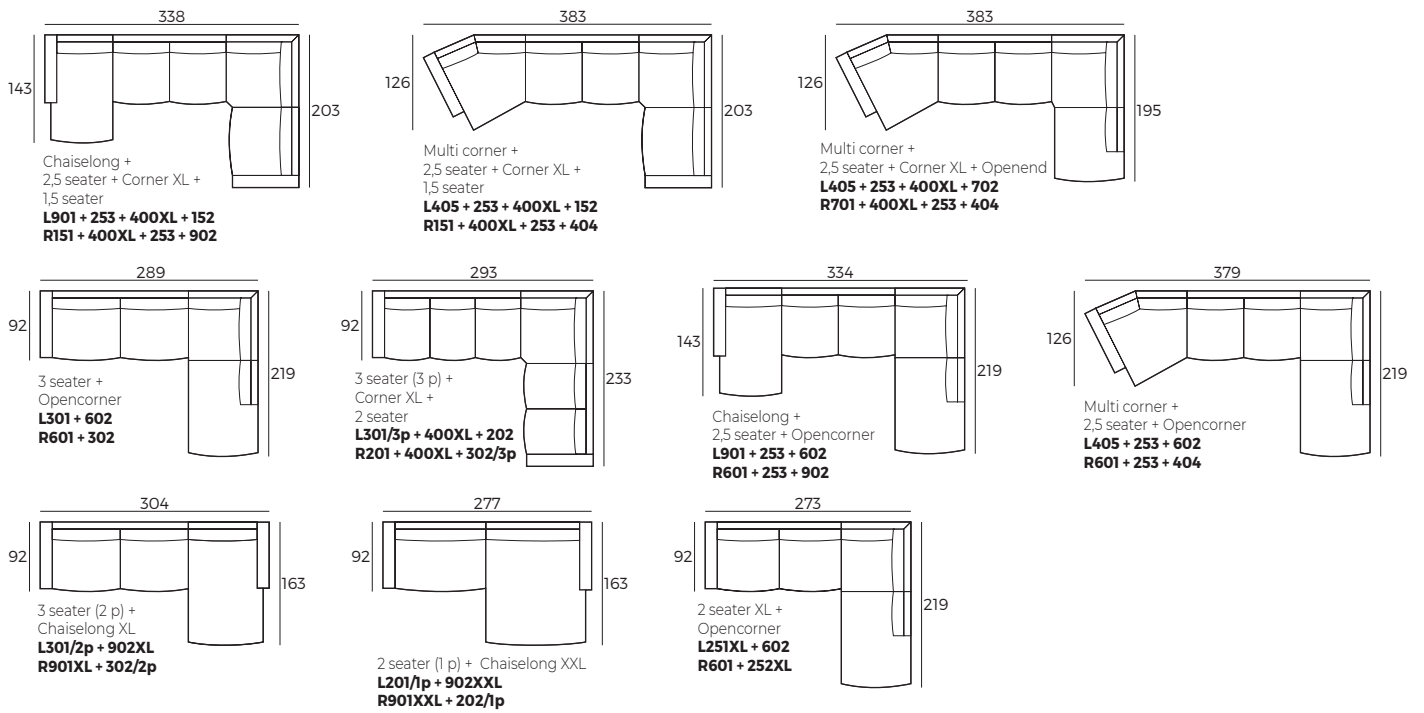

Accessories

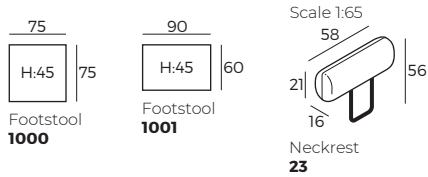

Loren



Loren



Comfort

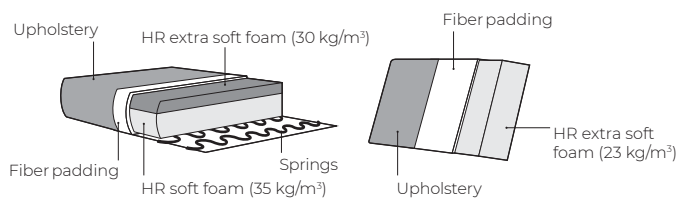

1. Upholstery



* Leather covers may require more stitches than fabric covers.

2. Armrests



1
W 23 x D 94 x H 46



2
W 23 x D 94 x H 39

Armrest 2 function



3. Legs



IMPORTANT:

Upholstered furniture is handmade using soft materials therefore measurements may vary up to **+/- 5 cm**.
Parts and sets shown in 2D drawings are left-sided. Parts and sets can be mirrored from left to right.

Single parts

Scale 1:100

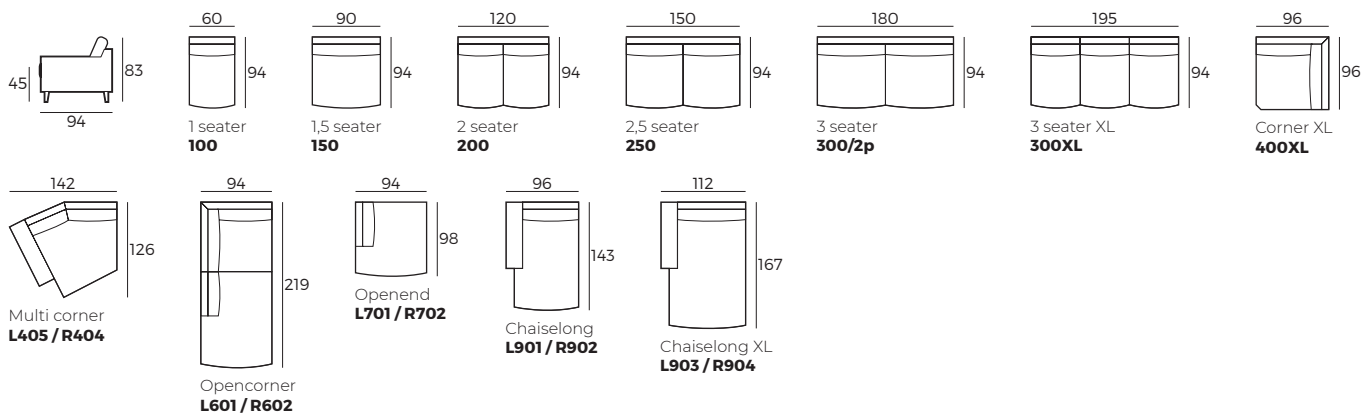

Loren

Scale 1:100

Half sets

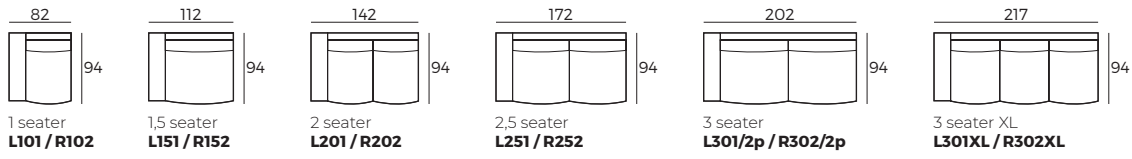

Sets

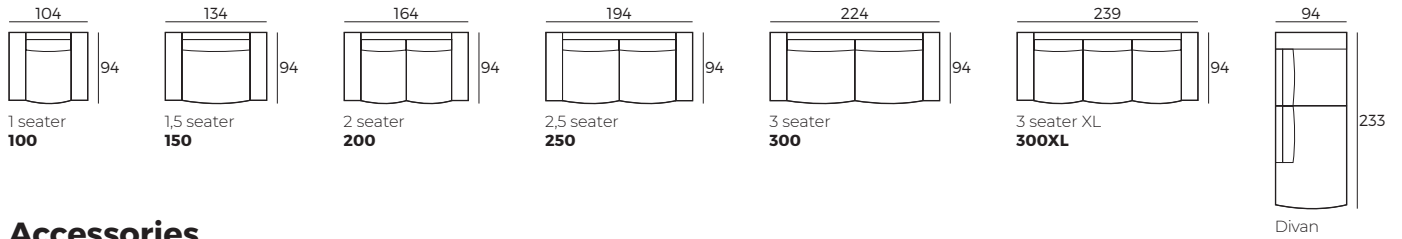

Accessories

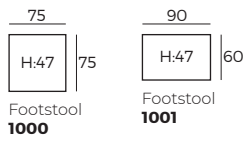

Lumi



Lumi



Comfort

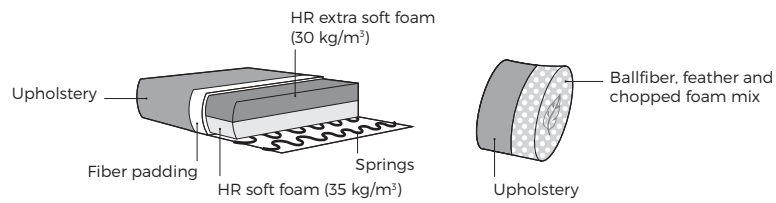

1. Upholstery



Fabric

2. Legs



17 cm

491
Metal

IMPORTANT:

Upholstered furniture is handmade using soft materials therefore measurements may vary up to +/- 5 cm.
 Parts and sets shown in 2D drawings are left-sided. Parts and sets can be mirrored from left to right.

Single parts

Scale 1:100

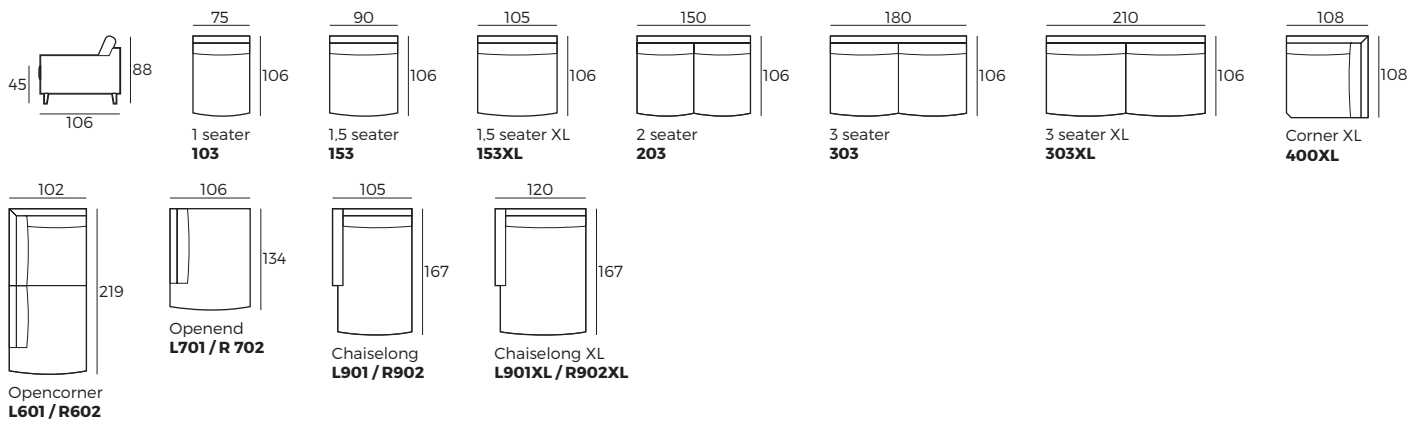

Lumi

Half sets

Scale 1:100

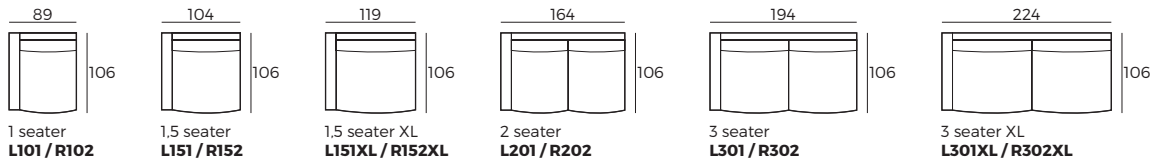

Sets

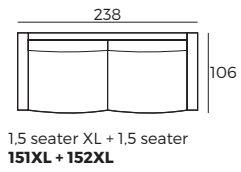
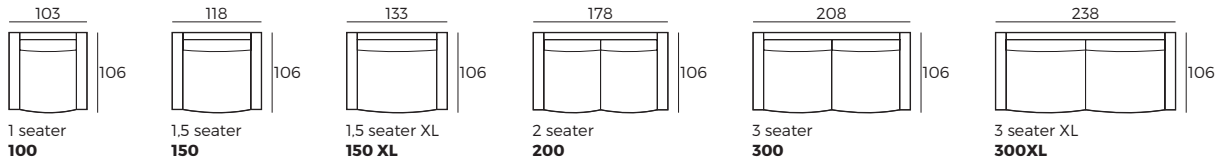

Accessories

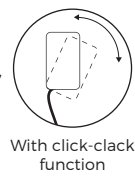
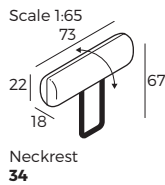
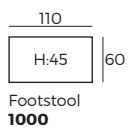

Maison



Maison



Comfort

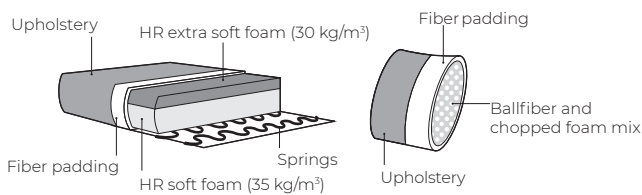

1. Upholstery



* Leather covers may require more stitches than fabric covers.

2. Armrests



3. Legs



IMPORTANT:

Upholstered furniture is handmade using soft materials therefore measurements may vary up to **+/- 5 cm**.
Parts and sets shown in 2D drawings are left-sided. Parts and sets can be mirrored from

Single parts (Measurements with Maison armrest)

Scale 1:100

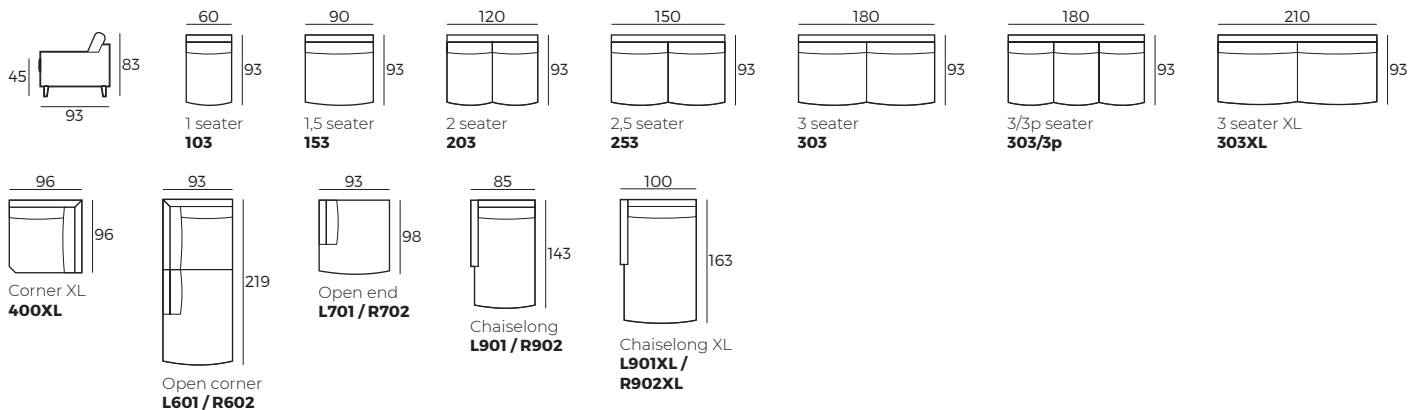

Maison

Half sets (Measurements with Maison armrest)

Scale 1:100

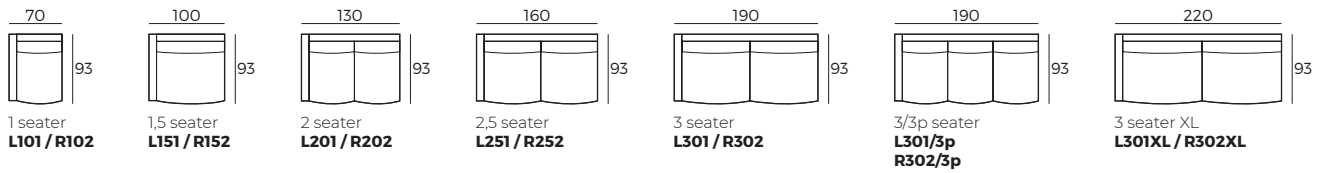

Sets (Measurements with Maison armrest)

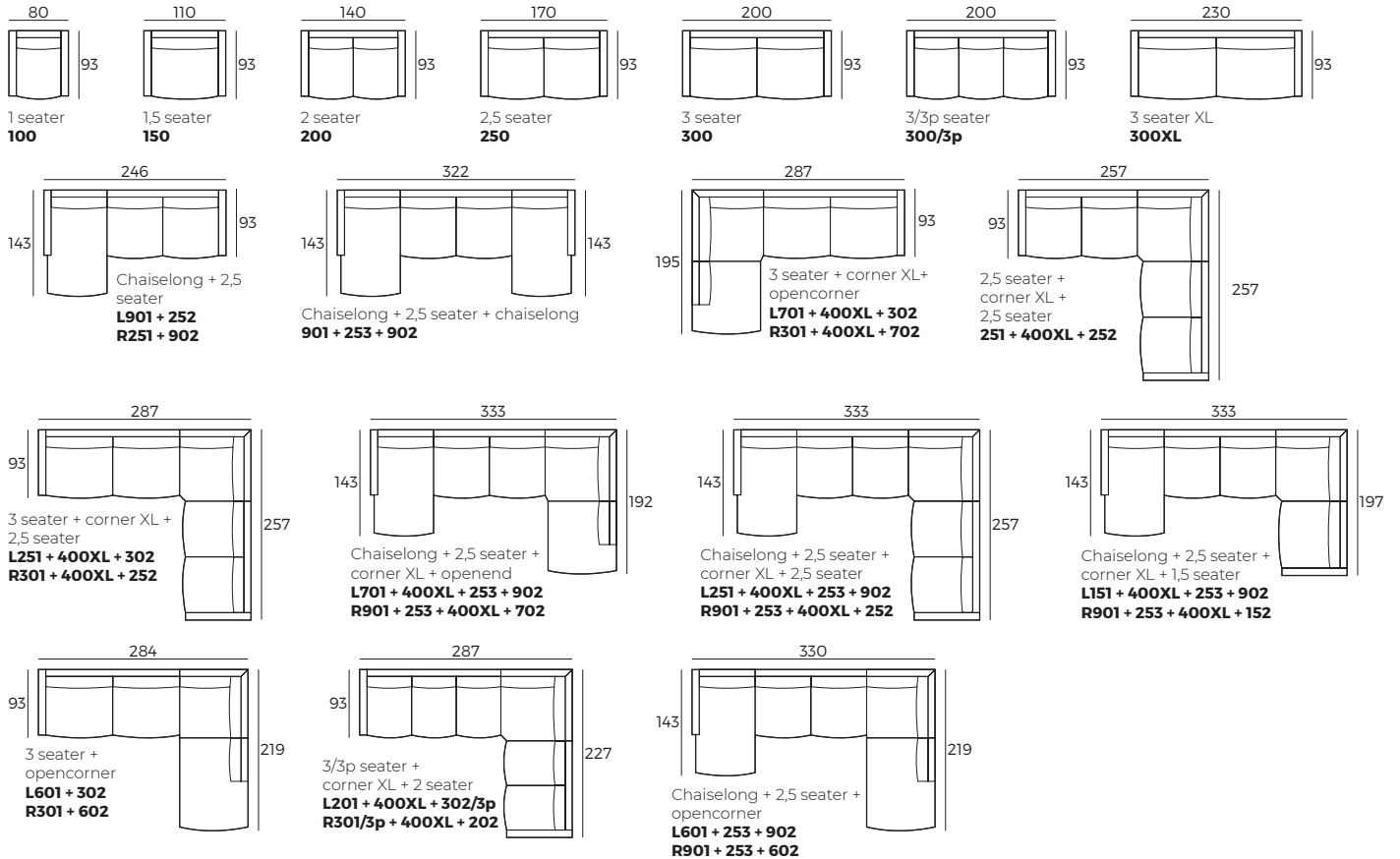

Accessories

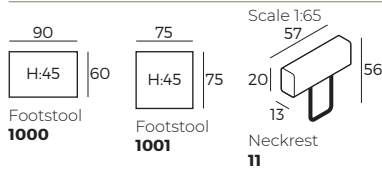

Malmo

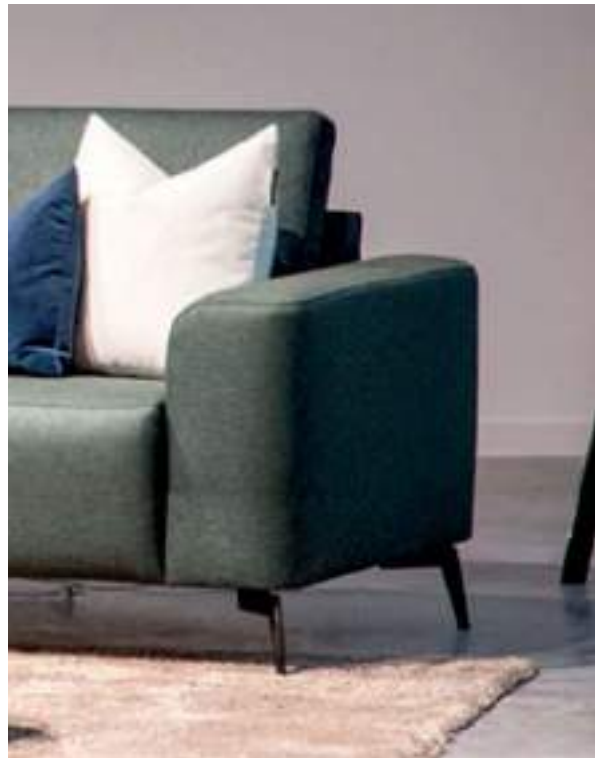

Malmo



Comfort

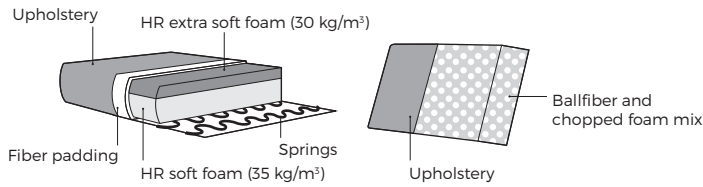

1. Upholstery



Fabric

2. Bi-Color option



3. Legs



IMPORTANT:

Upholstered furniture is handmade using soft materials therefore measurements may vary up to +/- 5 cm.
Parts and sets shown in 2D drawings are left-sided. Parts and sets can be mirrored from left to right.

Single parts

Scale 1:100

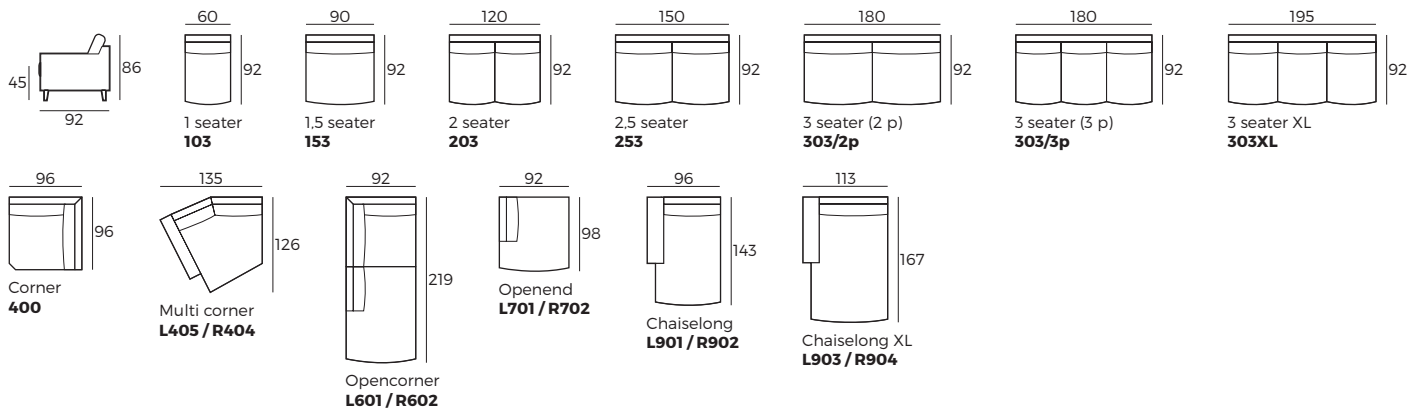

Malmo

Half sets

Scale 1:100

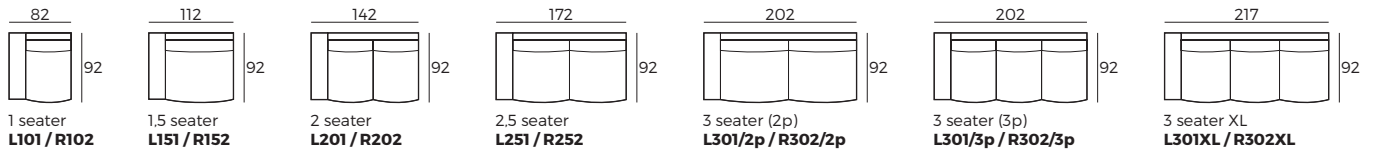

Sets

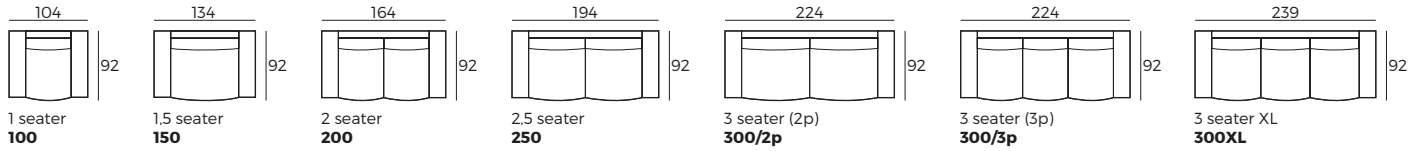

Accessories

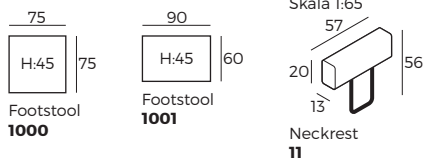

Mantanas



Mantanas



Comfort

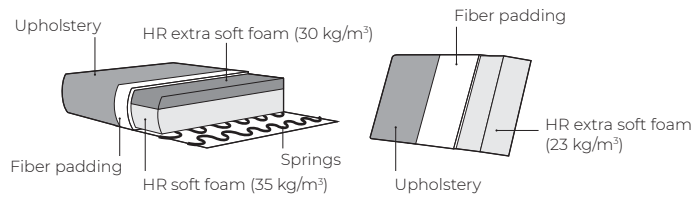

1. Upholstery



* Leather covers may require more stitches than fabric covers.

2. Headrest & seat type

*Measures with fully opened mechanism

1 Electrical

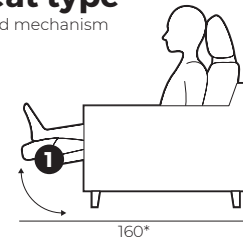

3. Armrests



4. Legs



IMPORTANT:

Upholstered furniture is handmade using soft materials therefore measurements may vary up to +/- 5 cm.
Parts and sets shown in 2D drawings are left-sided. Parts and sets can be mirrored from left to right.

Single parts

Scale 1:100

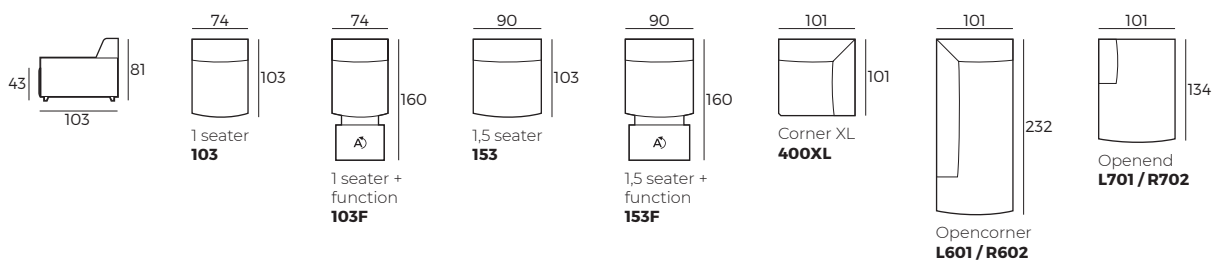

CUSTOM MADE COMFORT

Mantanas

Scale 1:100

Single parts

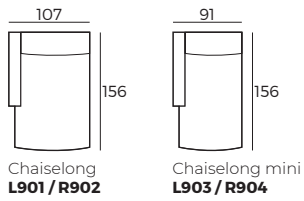

Half sets

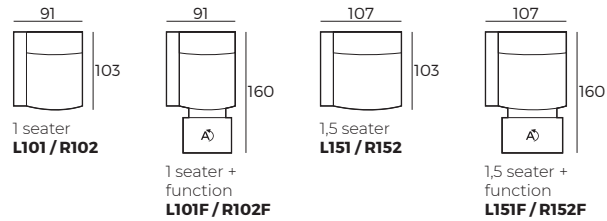

Sets

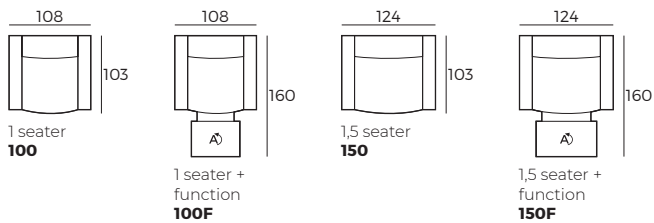

Accessories

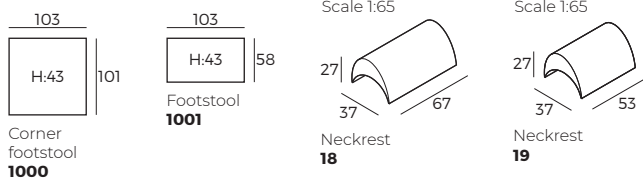

⌚ - electrical *F - single electric function

Martine



Martine



Comfort

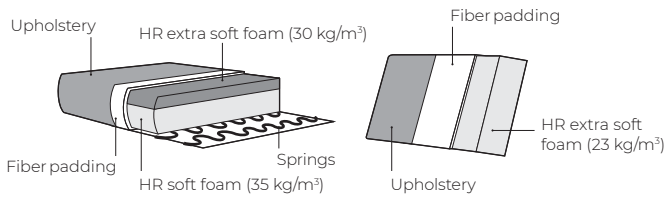

1. Upholstery



* Leather covers may require more stitches than fabric covers.

2. Headrest & seat type

*Measures with fully opened mechanism

- 1 Manual ↻ / Electrical ⏻
- 2 Electrical ⏻

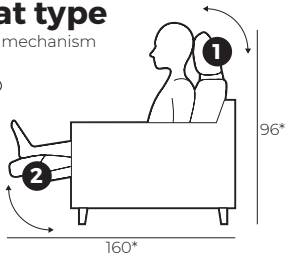

3. Bi-Color option

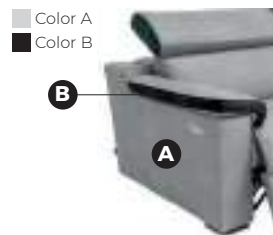

4. Legs



IMPORTANT:

Upholstered furniture is handmade using soft materials therefore measurements may vary up to +/- 5 cm.
Parts and sets shown in 2D drawings are left-sided. Parts and sets can be mirrored from left to right.

Single parts

Scale 1:100

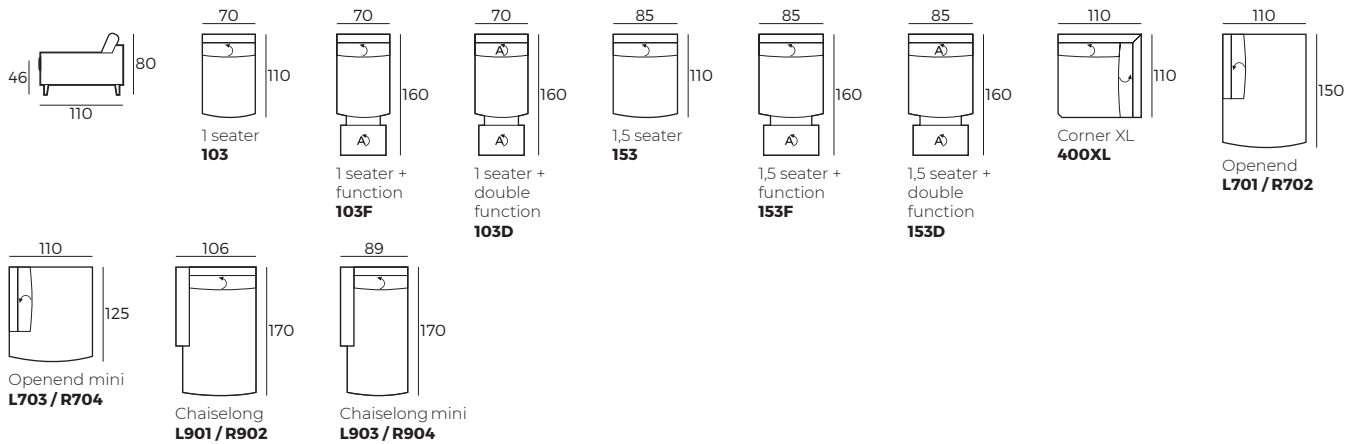

Martine

Scale 1:100

Half sets

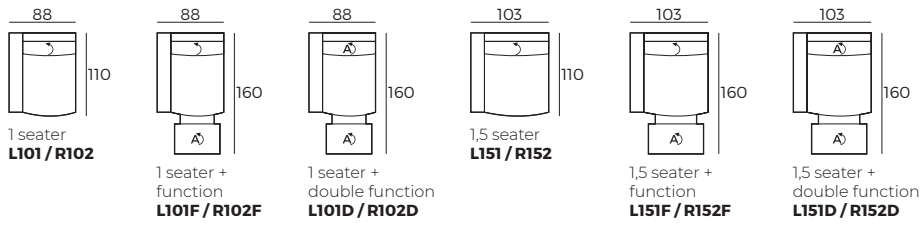

Sets

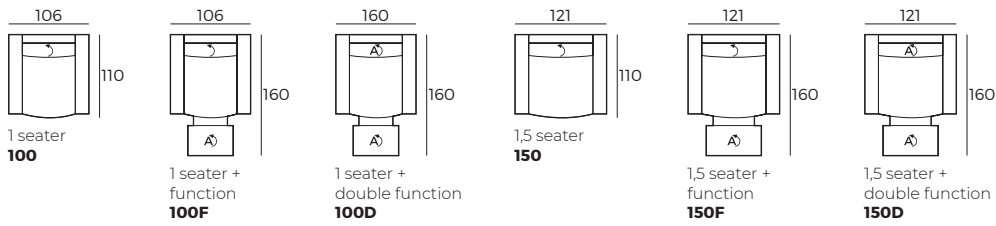

Accessories

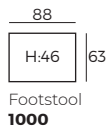

↷ - manual; ⚡ - electrical *F - single electric function; *D - double electric function

Menson



Menson



Comfort

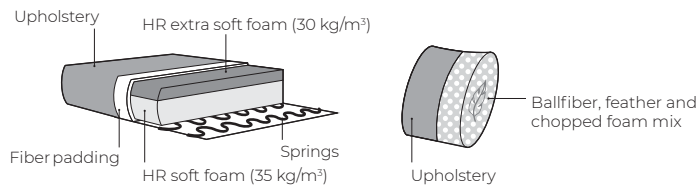

1. Upholstery



Fabric

2. Legs



IMPORTANT:

Upholstered furniture is handmade using soft materials therefore measurements may vary up to **+/- 5 cm**.
Parts and sets shown in 2D drawings are left-sided. Parts and sets can be mirrored from left to right.

Single parts

Scale 1:100

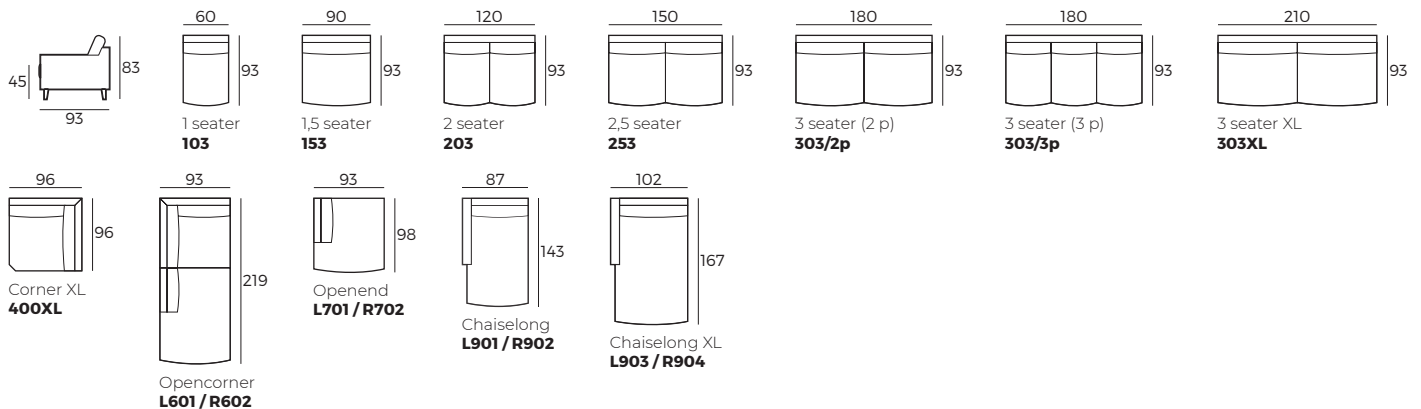

Menson

Half sets

Scale 1:100

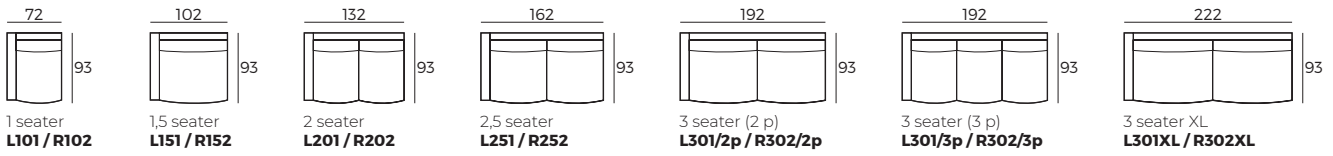

Sets

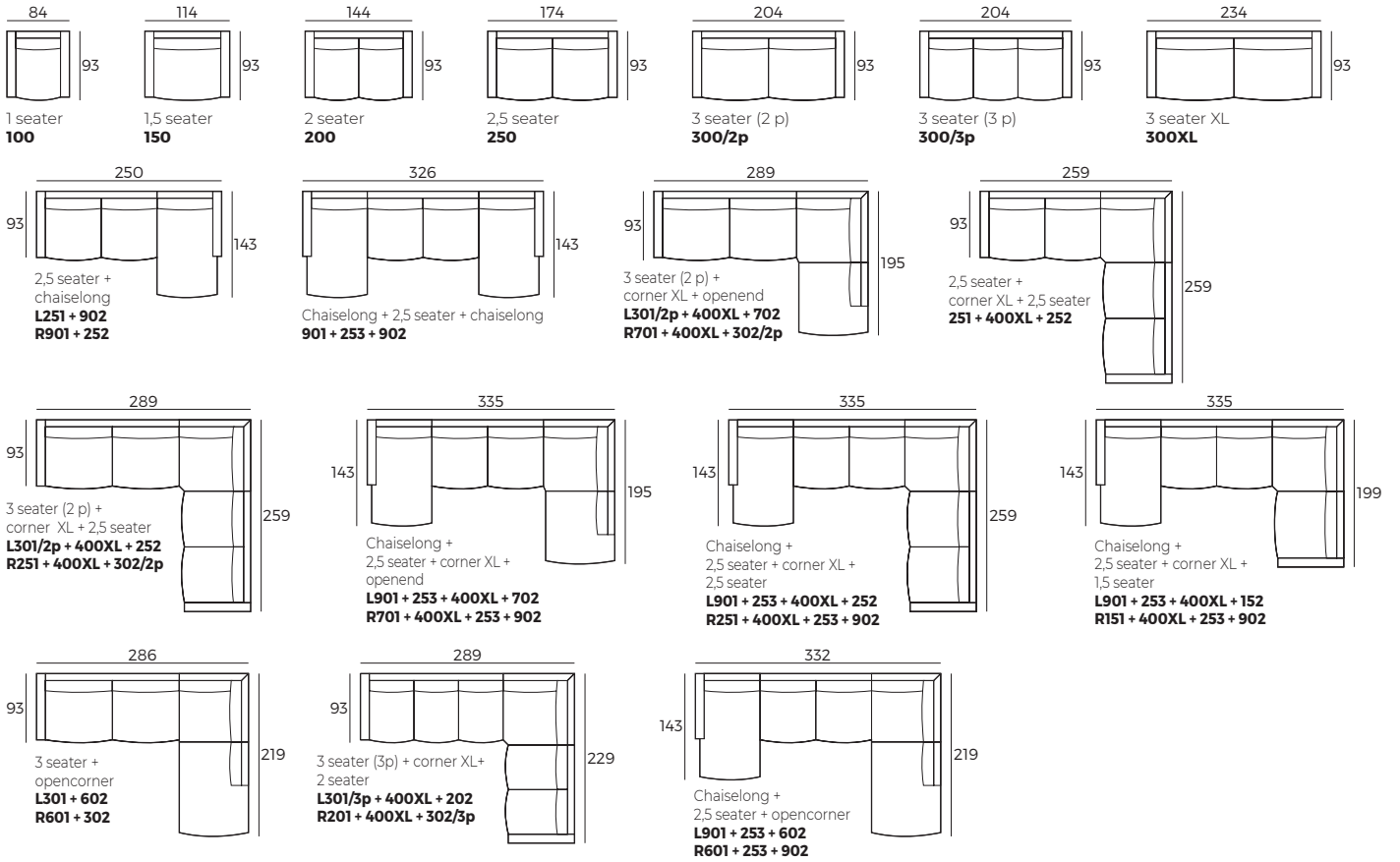

Accessories

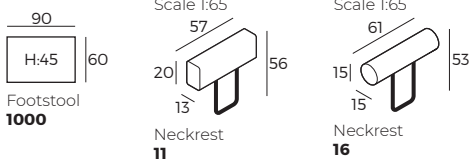

Milla



Milla



Comfort

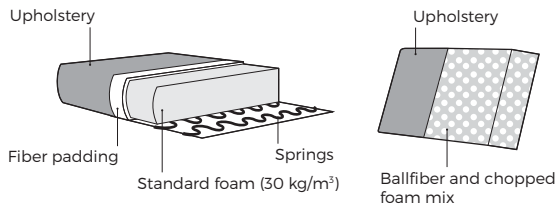

1. Upholstery



Fabric

2. Legs



IMPORTANT:

Upholstered furniture is handmade using soft materials therefore measurements may vary up to **+/- 5 cm**.
Parts and sets shown in 2D drawings are left-sided. Parts and sets can be mirrored from left to right.

Sets

Scale 1:100

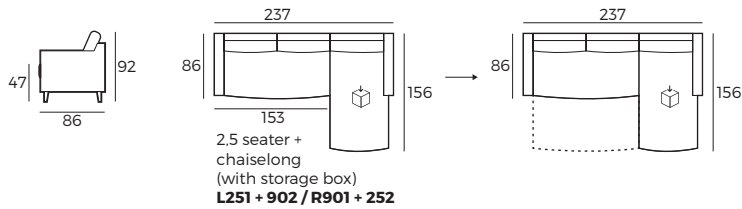

2.5 seater +
chaiselong
(with storage box)
L251 + 902 / R901 + 252

Molte



Molte



Comfort

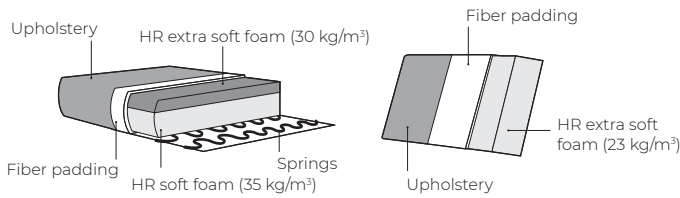

1. Upholstery



* Leather covers may require more stitches than fabric covers.

3. Legs



IMPORTANT:

Upholstered furniture is handmade using soft materials therefore measurements may vary up to **+/- 5 cm**.
Parts and sets shown in 2D drawings are left-sided. Parts and sets can be mirrored from left to right.

Single parts

Scale 1:100

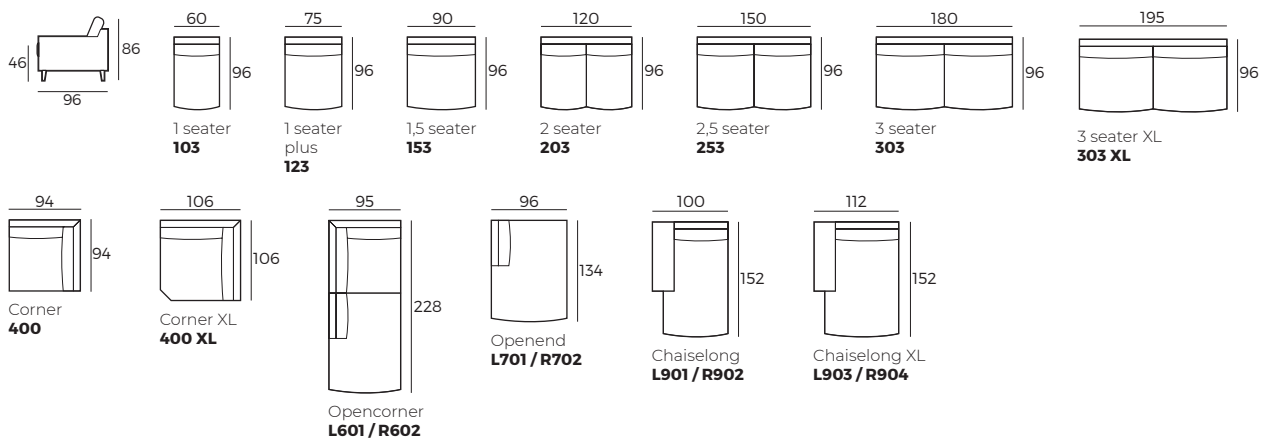

Molte

Half sets

Scale 1:100

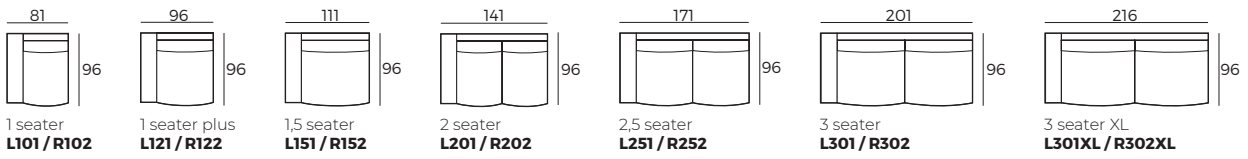

Sets (Measurements with Grande armrest)

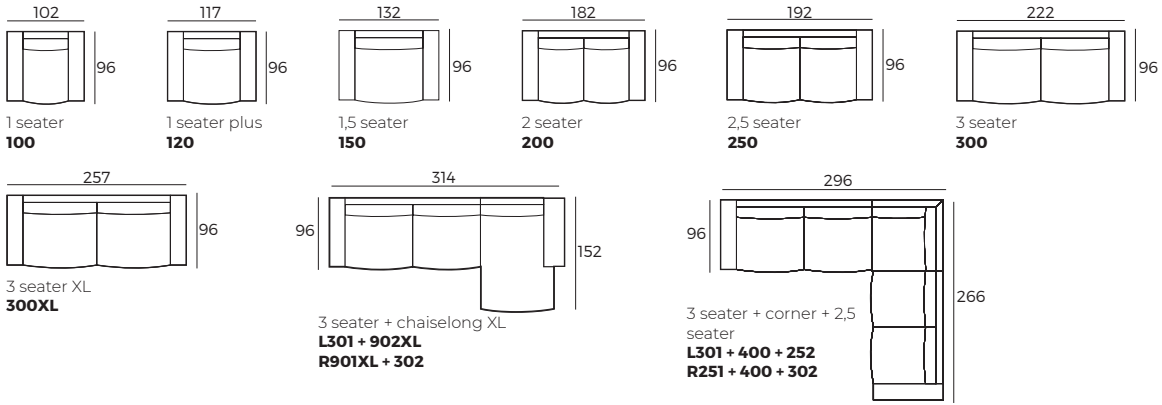

Accessories

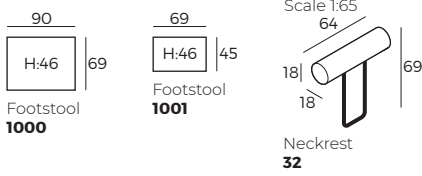

Montreal



Montreal



Comfort

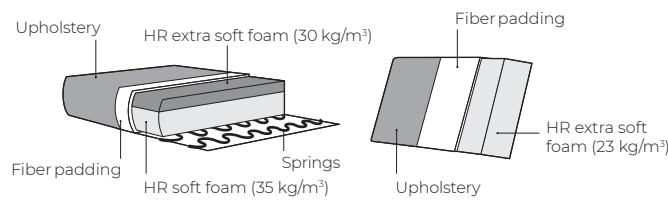

1. Upholstery



* Leather covers may require more stitches than fabric covers.

2. Headrest & seat type

*Measures with fully opened mechanism

- 1 Manual ↗ / Electrical ⌂
- 2 Electrical ⌂

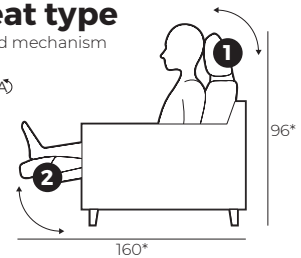

3. Armrests



Martine
W 18 x D 104 x H 61

Montreal
W 21 x D 111 x H 57

4. Multicolor option



5. Legs



IMPORTANT:

Upholstered furniture is handmade using soft materials therefore measurements may vary up to +/- 5 cm.
Parts and sets shown in 2D drawings are left-sided. Parts and sets can be mirrored from left to right.
Single parts both sides are fully upholstered.

Single parts (Measurements with Montreal armrest)

Scale 1:100

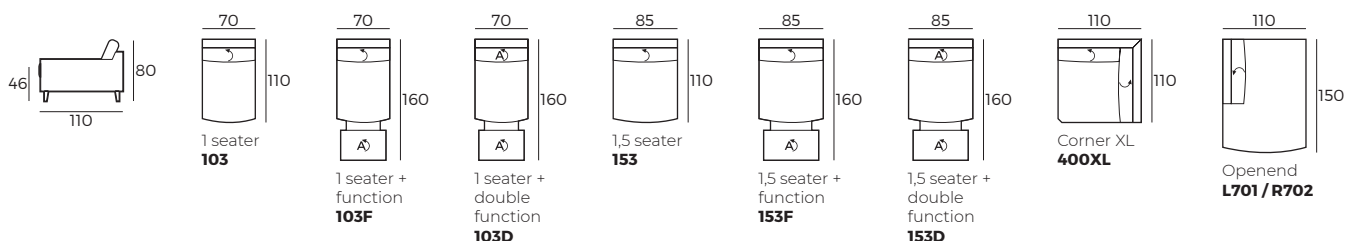

CUSTOM MADE COMFORT

Montreal

Half sets (Measurements with Montreal armrest)

Scale 1:100

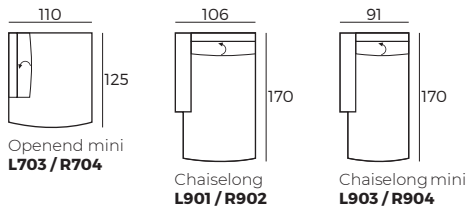

Half sets (Measurements with Montreal armrest)

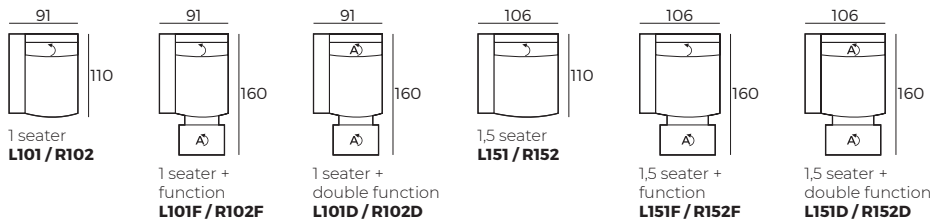

Sets (Measurements with Montreal armrest)

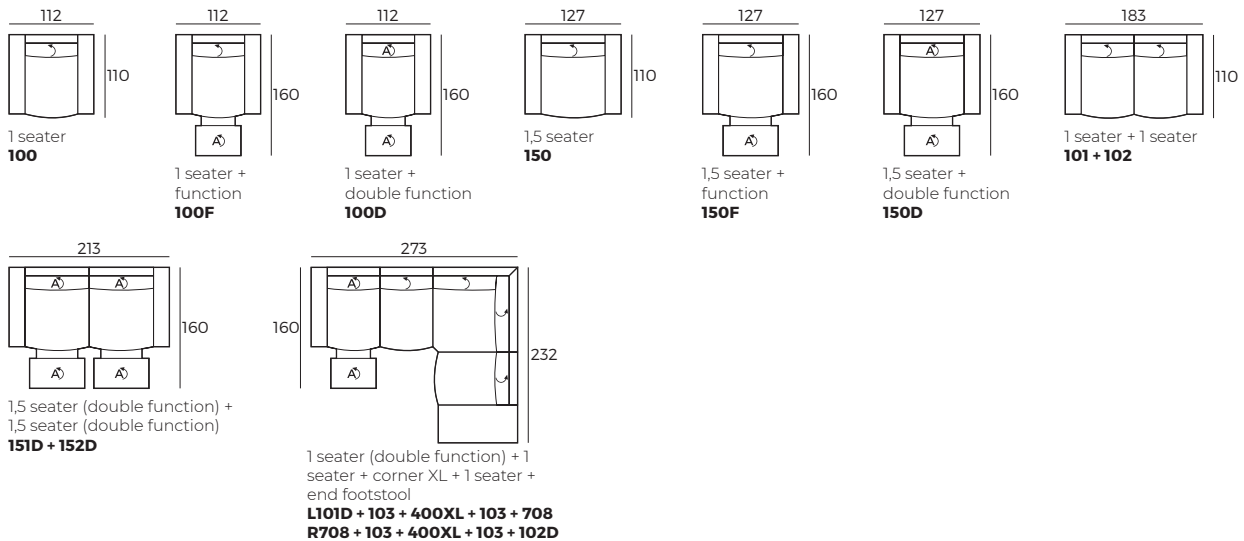

Accessories

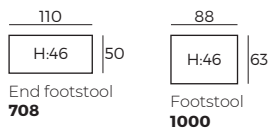

↶ - manual; ⚡ - electrical *F - single electric function; *D - double electric function

Moody

modular



Moody modular



Comfort

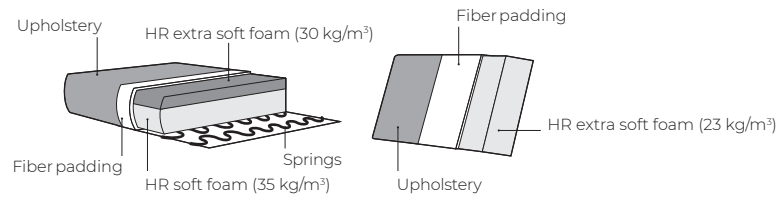

1. Upholstery



Leather*

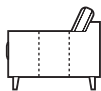

Fabric

* Leather covers may require more stitches than fabric covers.

2. Headrest & seat type

*Measures with fully opened mechanism

- 1 Manual ↗
- 2 Electrical ↕

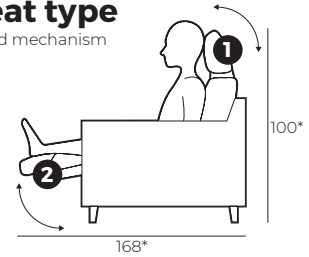

3. Armrest function



Fully closed W 11 x D 95 x H 66 **Fully opened** W 21 x D 95 x H 54

4. Multicolor option



5. Legs



IMPORTANT:

Upholstered furniture is handmade using soft materials therefore measurements may vary up to +/- 5 cm.
Parts and sets shown in 2D drawings are left-sided. Parts and sets can be mirrored from left to right.

Single parts (Measurements with fully opened armrest)

Scale 1:100

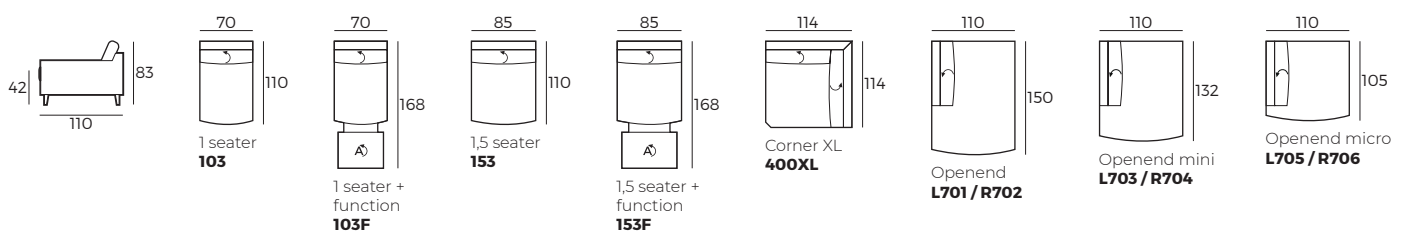

CUSTOM MADE COMFORT

Single parts (Measurements with fully opened armrest)

Scale 1:100

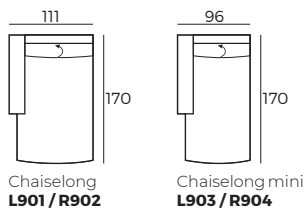

Chaiselong
L901 / R902

Chaiselong mini
L903 / R904

Half sets (Measurements with fully opened armrest)

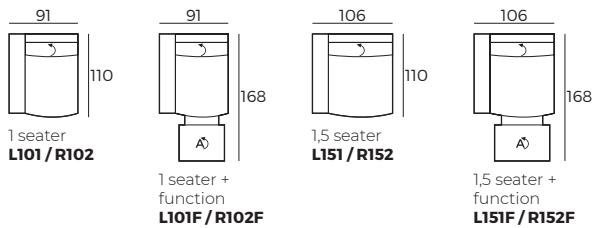

Sets (Measurements with fully opened armrest)

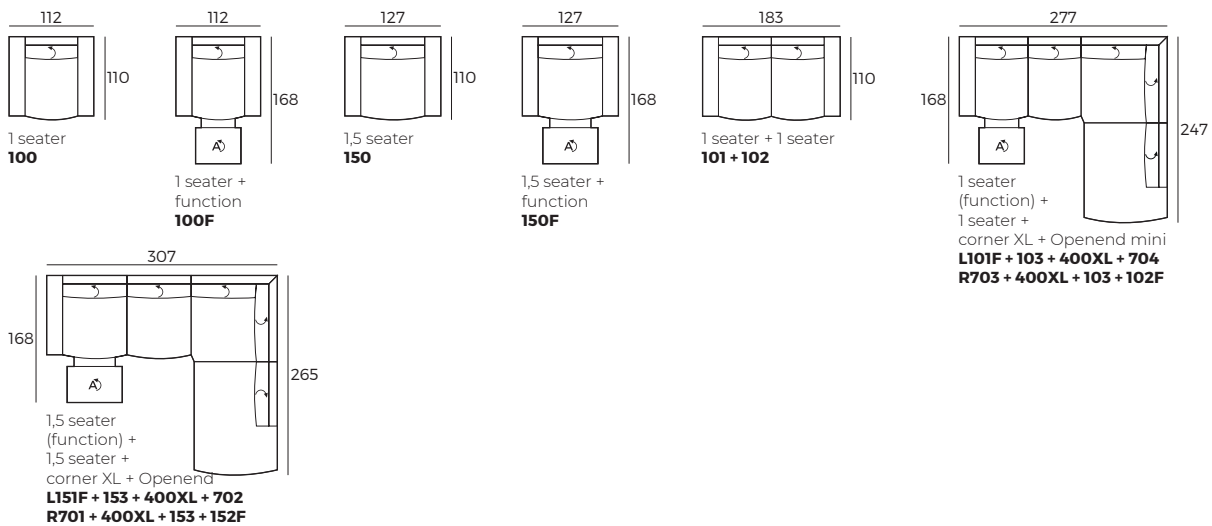

Accessories

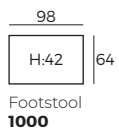

Footstool
1000

↵ - manual; ⚡ - electrical *F - single electric function

Moody



Moody



Comfort

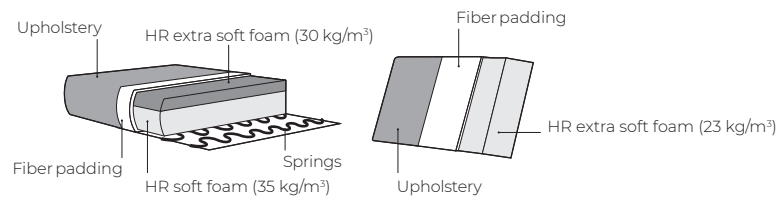

1. Upholstery



* Leather covers may require more stitches than fabric covers.

2. Headrest & seat type

*Measures with fully opened mechanism

- 1 Manual ↷
- 2 Electrical ⚡

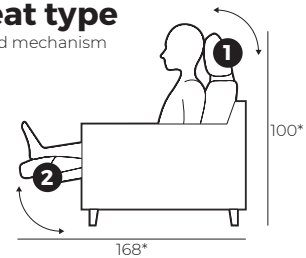

3. Armrest function



Fully closed W 11 x D 95 x H 66
Fully opened W 21 x D 95 x H 54

4. Bi-Color option



5. Legs



IMPORTANT:

Upholstered furniture is handmade using soft materials therefore measurements may vary up to +/- 5 cm.
 Parts and sets shown in 2D drawings are left-sided. Parts and sets can be mirrored from left to right.

Single parts (Measurements with fully opened armrest)

Scale 1:100

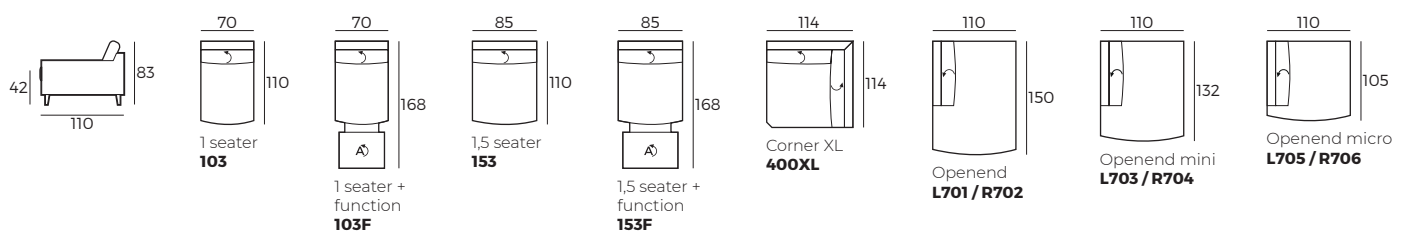

Moody

Single parts (Measurements with fully opened armrest)

Scale 1:100

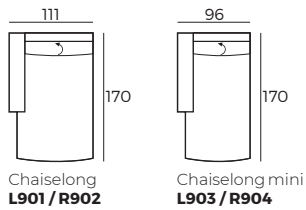

Half sets (Measurements with fully opened armrest)

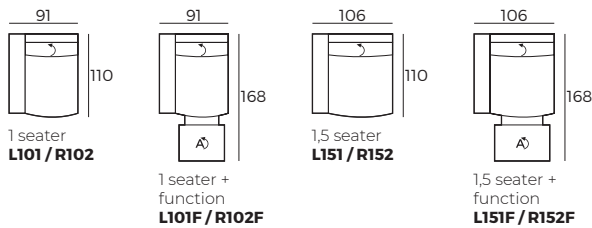

Sets (Measurements with fully opened armrest)

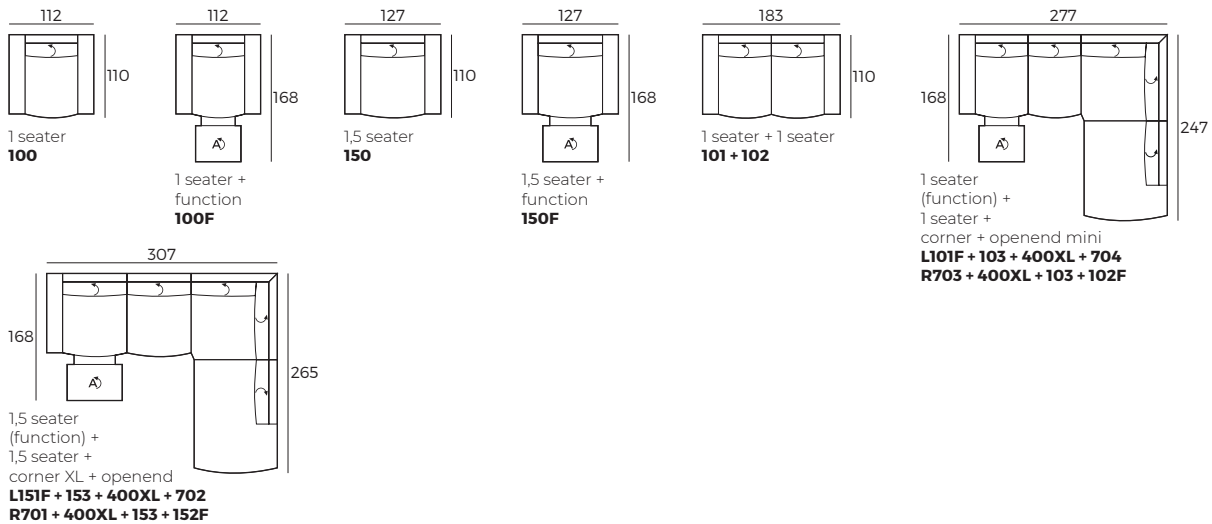

Accessories

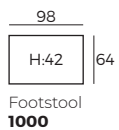

↵ - manual; ⚡ - electrical *F - single electric function

More plus



More plus



Comfort

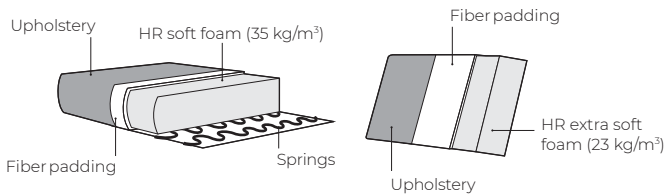

1. Upholstery



* Leather covers may require more stitches than fabric covers.

2. Armrests



Omega* W 3 x D 96 x H 65
Polo W 17 x D 96 x H 52
Bento W 21 x D 96 x H 59
Gusta W 22 x D 96 x H 66
Como W 29 x D 96 x H 56
Grande W 31 x D 96 x H 57

*Not suitable for chaiselong

3. Legs

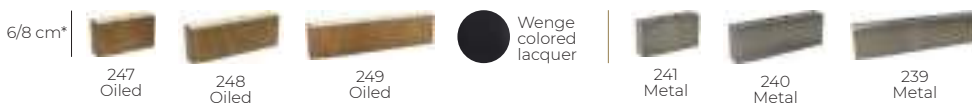

* The height of all legs can be either 6 cm or 8 cm.

IMPORTANT:

Upholstered furniture is handmade using soft materials therefore measurements may vary up to +/- 5 cm.
 Parts and sets shown in 2D drawings are left-sided. Parts and sets can be mirrored from left to right.

Single parts

Scale 1:100

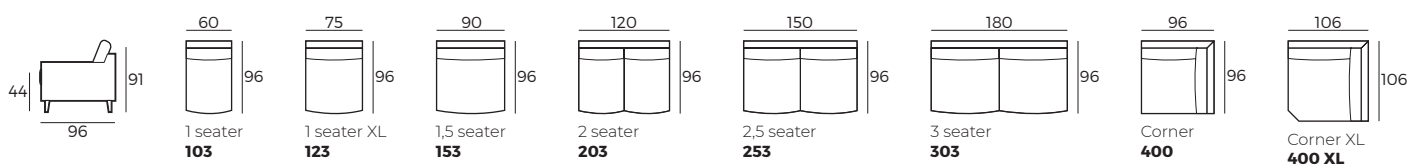

CUSTOM MADE COMFORT

More plus

Single parts

Scale 1:100

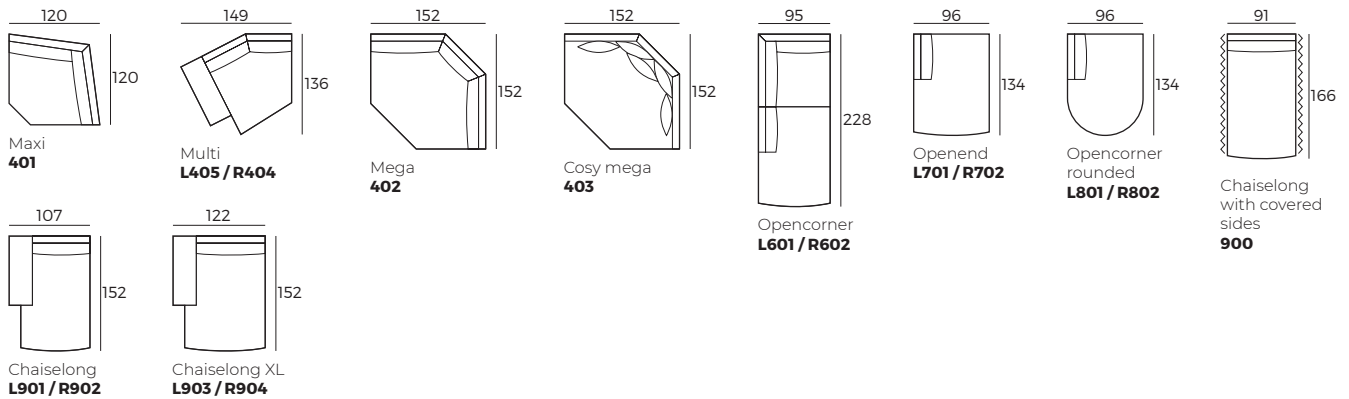

Half sets

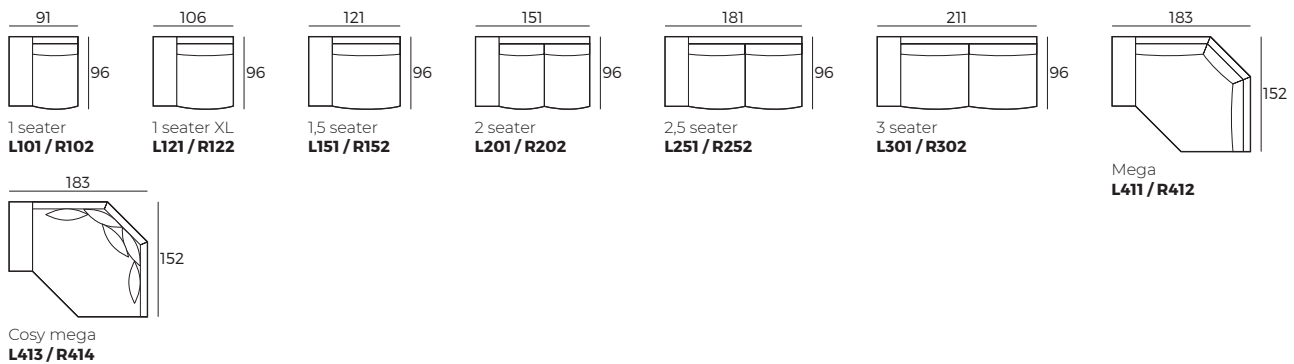

Sets

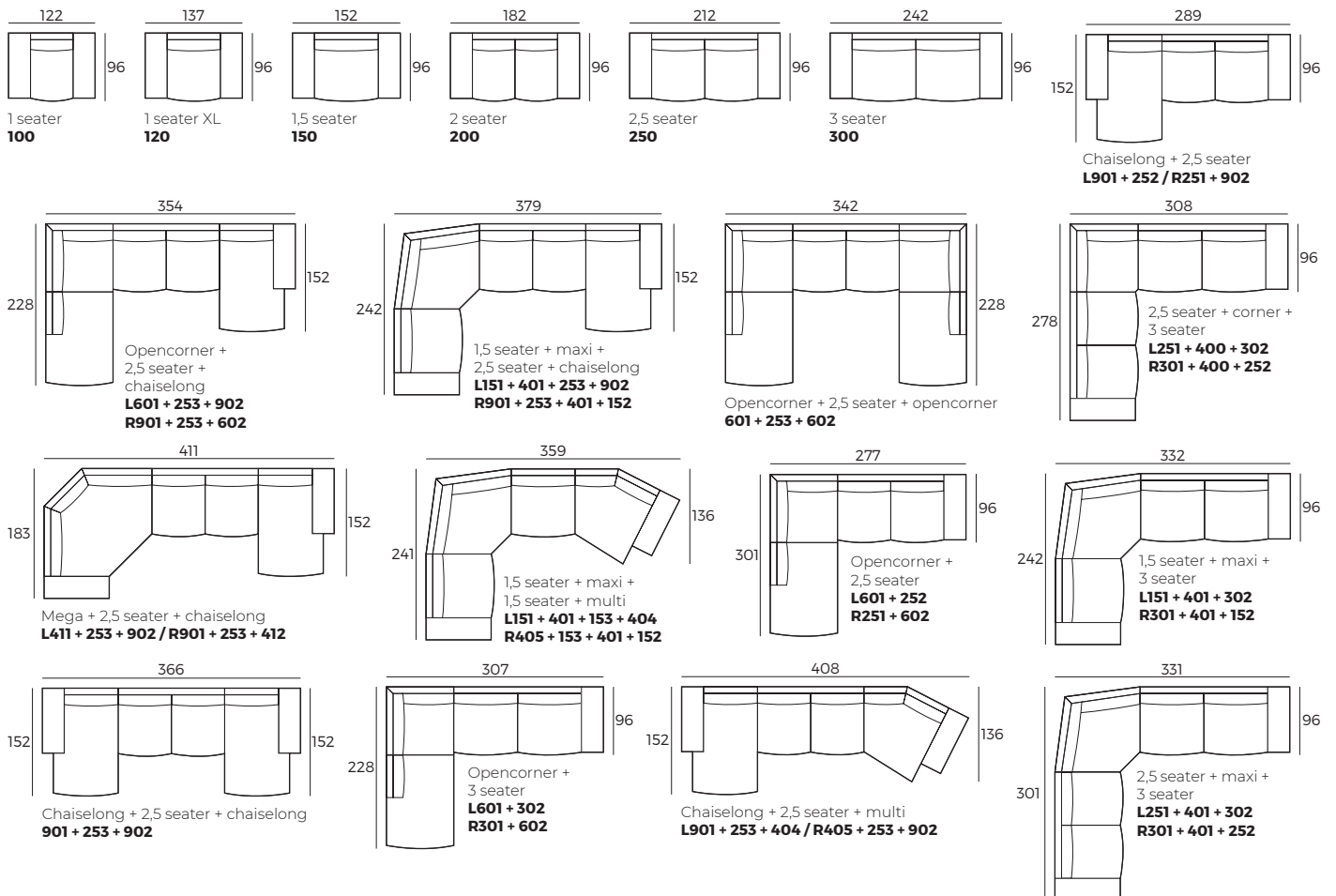

More plus

Sets (Measurements with Grande armrest)

Scale 1:100

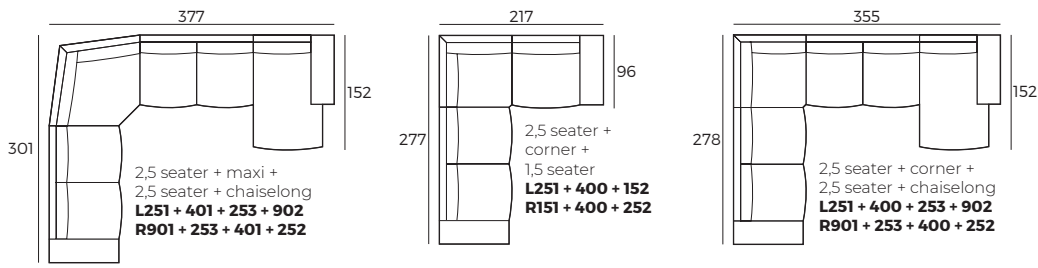

Accessories

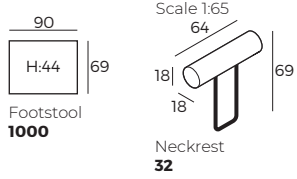

More



More



Comfort

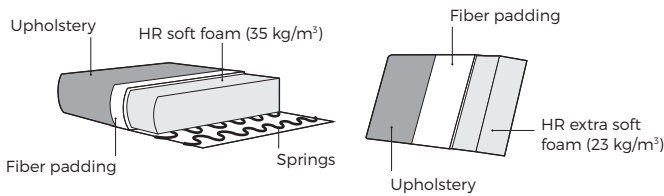

1. Upholstery

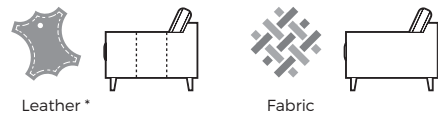

* Leather covers may require more stitches than fabric covers.

2. Armrests



3. Legs

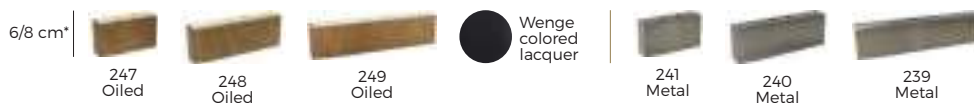

* The height of all legs can be either 6 cm or 8 cm.

IMPORTANT:

Upholstered furniture is handmade using soft materials therefore measurements may vary up to +/- 5 cm.
Parts and sets shown in 2D drawings are left-sided. Parts and sets can be mirrored from left to right.

Single parts (Measurements with Grande armrest)

Scale 1:100

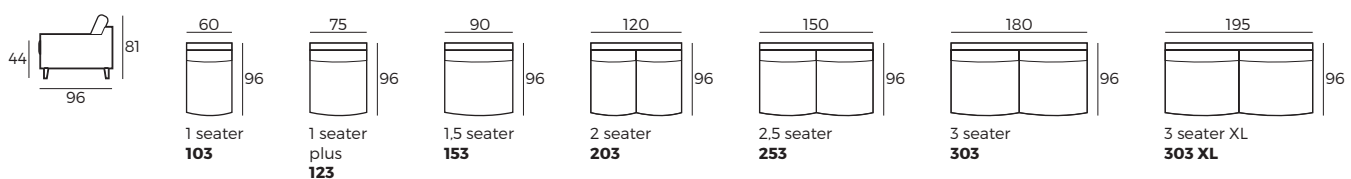

CUSTOM MADE COMFORT

More

Single parts (Measurements with Grande armrest)

Scale 1:100

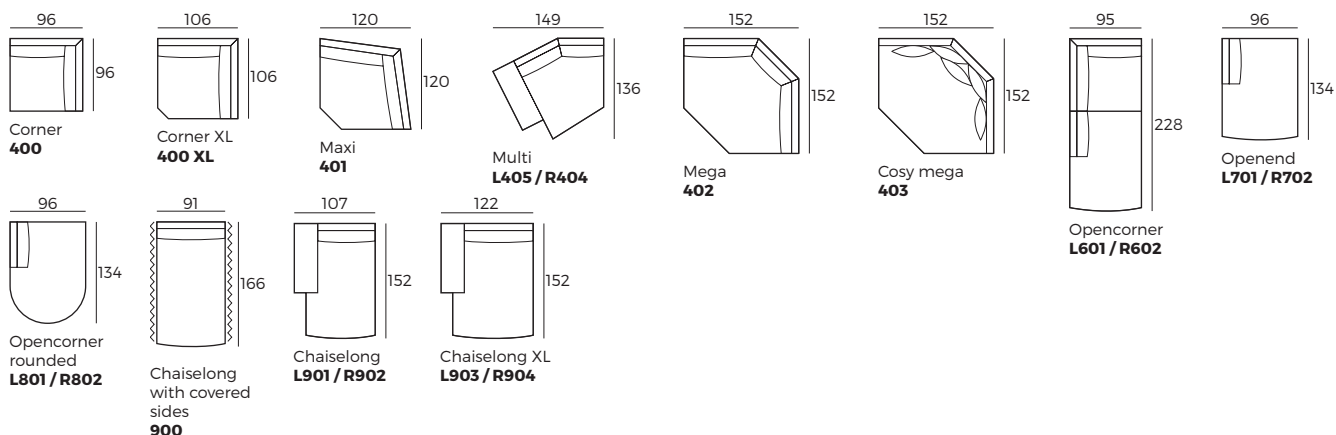

Half sets (Measurements with Grande armrest)

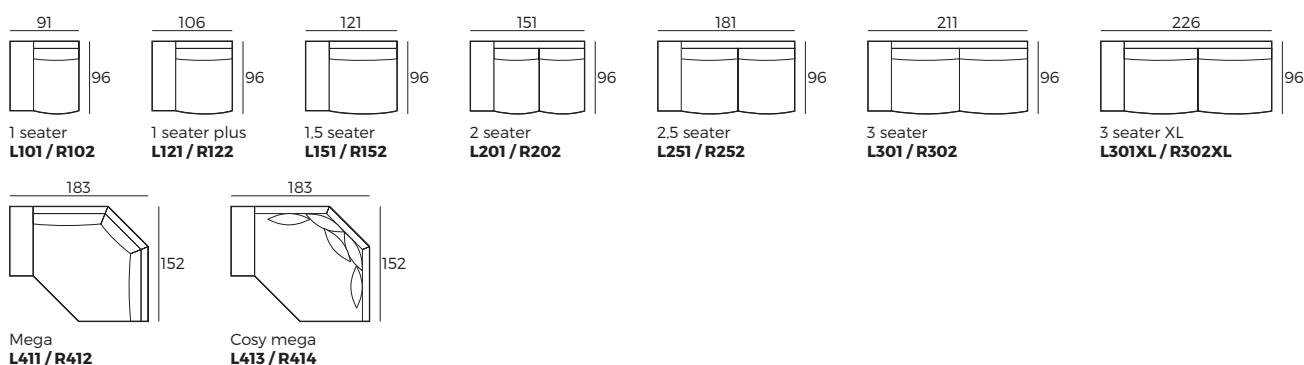

Sets (Measurements with Grande armrest)

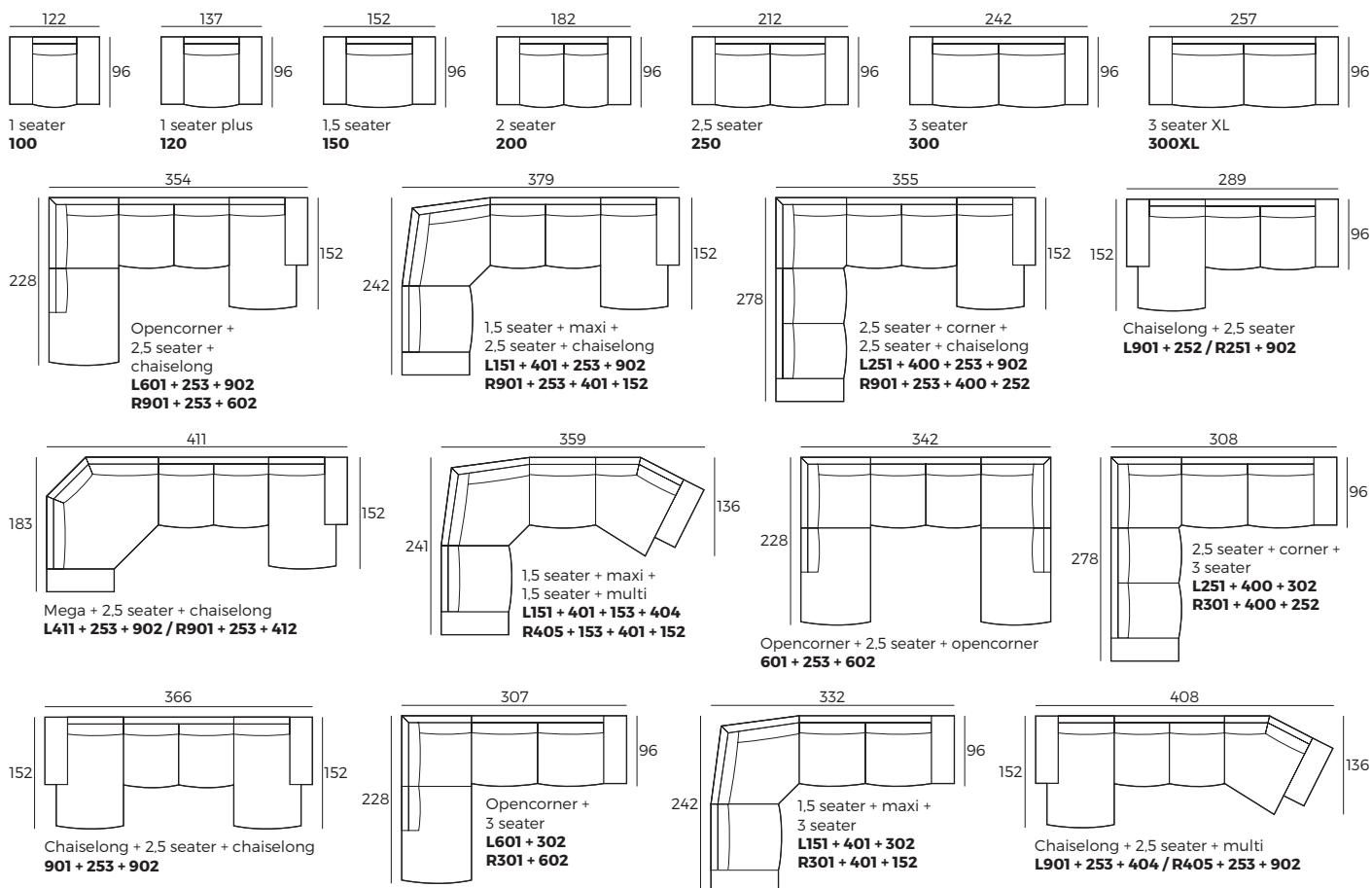

More

Sets (Measurements with Grande armrest)

Scale 1:100

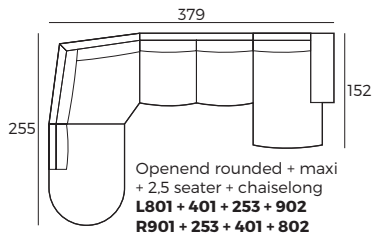

Accessories

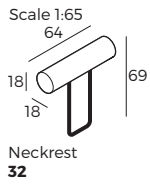
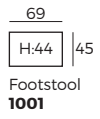
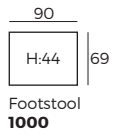

Noa



Noa



Comfort

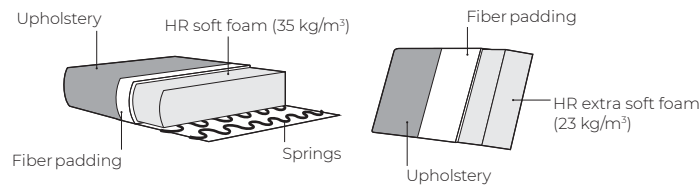

1. Upholstery



* Leather covers may require more stitches than fabric covers.

2. Legs

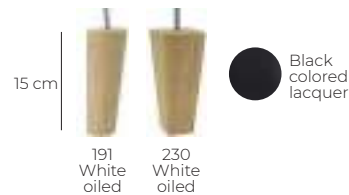

Chaiselong footstool assembly

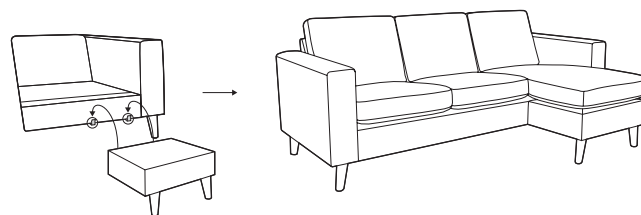

IMPORTANT:

Upholstered furniture is handmade using soft materials therefore measurements may vary up to +/- 5 cm.
Parts and sets shown in 2D drawings are left-sided. Parts and sets can be mirrored from left to right.

Sets

Scale 1:100

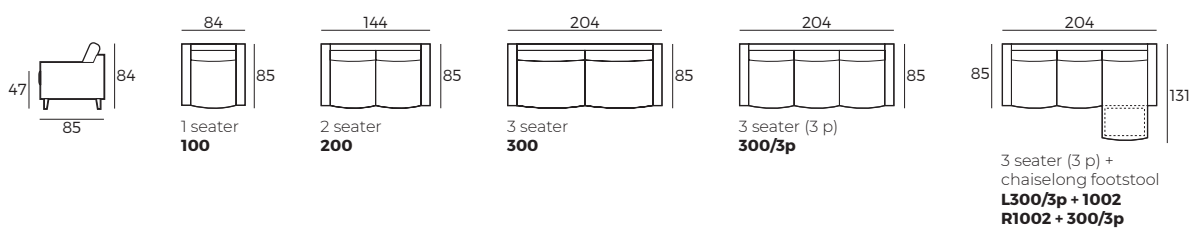

CUSTOM MADE COMFORT

Noa

Sets

Scale 1:100

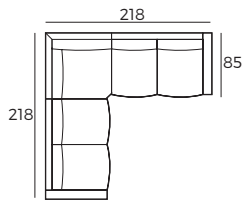

2 seater + corner XL +
2 seater
201 + 400 + 202

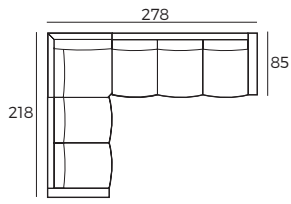

2 seater + corner XL + 3 seater (3 p)
L201 + 400XL + 302/3p
R301/3p + 400XL + 202

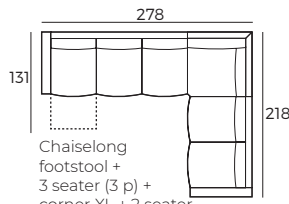

Chaiselong
footstool +
3 seater (3 p) +
corner XL + 2 seater
L1002 + 301/3p + 400XL + 202
R201 + 400XL + 302/3p + 1002

Accessories



Footstool
1000

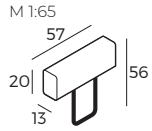

Neckrest
11

Nordic plus



Nordic plus



Comfort

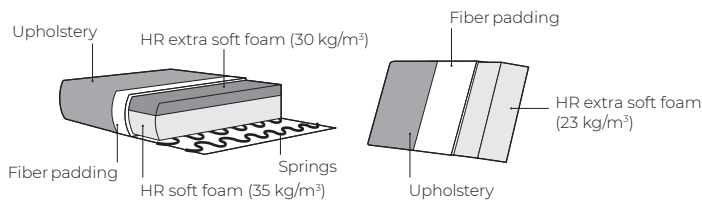

1. Upholstery



* Leather covers may require more stitches than fabric covers.

2. Armrests



Omega* W 3 x D 90 x H 53 **Style** W 9 x D 90 x H 53 **Slim** W 9 x D 90 x H 53 **Fancy** W 11 x D 90 x H 53 **Less** W 12 x D 90 x H 48 **Polo** W 13 x D 90 x H 53 **Share** W 16 x D 90 x H 48 **Duo** W 20 x D 90 x H 53 **Evo** W 20 x D 90 x H 49

3. Legs

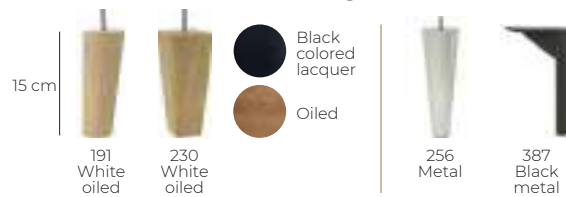

IMPORTANT:

Upholstered furniture is handmade using soft materials therefore measurements may vary up to +/- 5 cm.
Parts and sets shown in 2D drawings are left-sided. Parts and sets can be mirrored from left to right.

Single parts (Measurements with Share armrest)

Scale 1:100

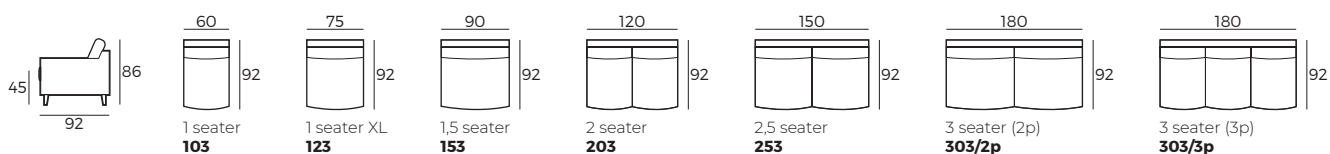

Nordic plus

Single parts (Measurements with Share armrest)

Scale 1:100

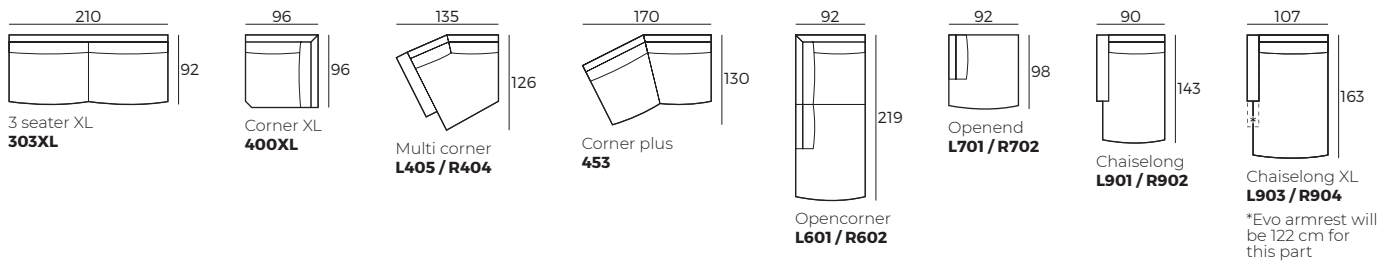

Half sets (Measurements with Share armrest)

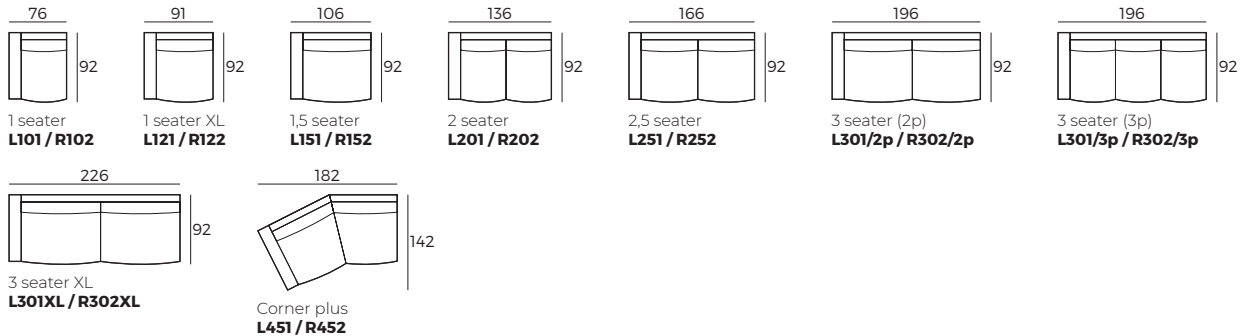

Sets (Measurements with Share armrest)

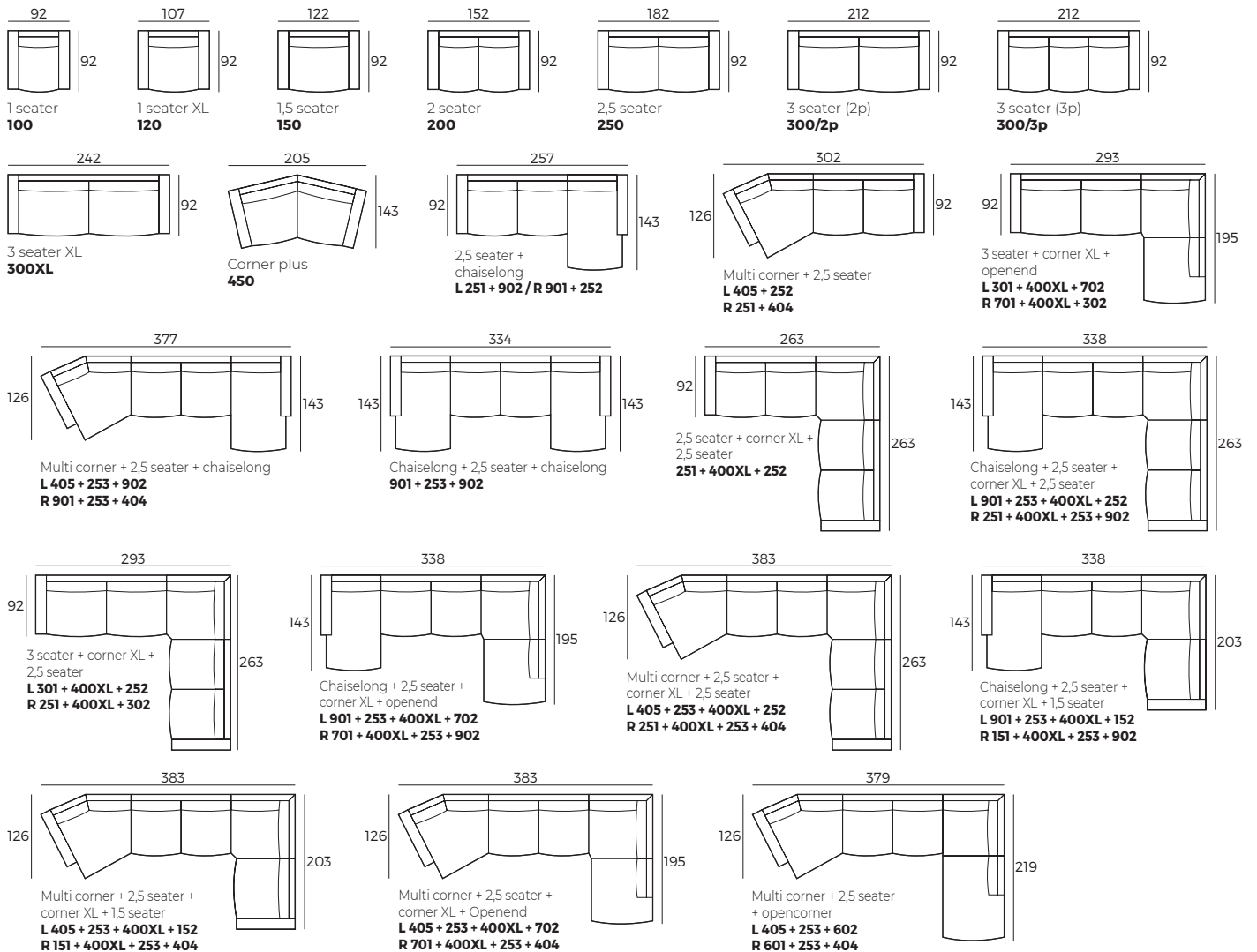

Nordic plus

Sets (Measurements with Share armrest)

Scale 1:100

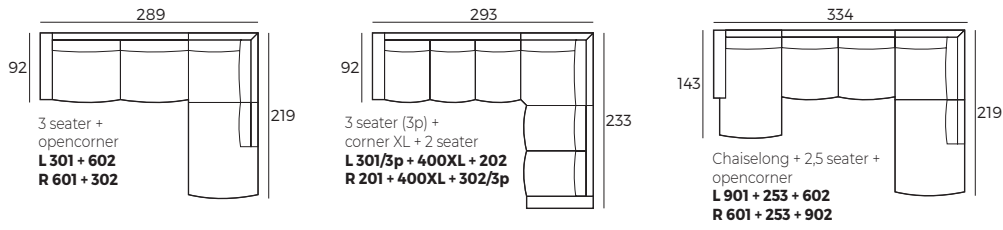

Accessories

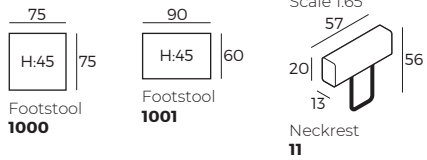

Nordic



Nordic



Comfort

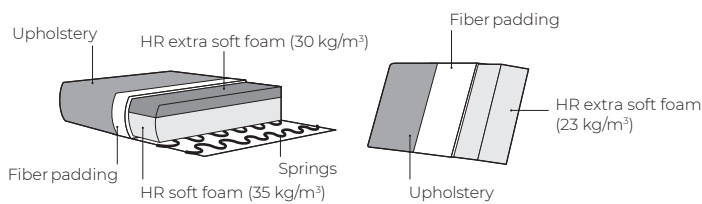

1. Upholstery



* Leather covers may require more stitches than fabric covers.

2. Armrests



Omega* W 3 x D 90 x H 53 **Style** W 9 x D 90 x H 53 **Slim** W 9 x D 90 x H 53 **Fancy** W 11 x D 90 x H 53 **Less** W 12 x D 90 x H 48 **Polo** W 13 x D 90 x H 53 **Share** W 16 x D 90 x H 48 **Duo** W 20 x D 90 x H 53 **Evo** W 20 x D 90 x H 49

3. Legs



IMPORTANT:

Upholstered furniture is handmade using soft materials therefore measurements may vary up to **+/- 5 cm**.
Parts and sets shown in 2D drawings are left-sided. Parts and sets can be mirrored from left to right.

Single parts (Measurements with Share armrest)

Scale 1:100

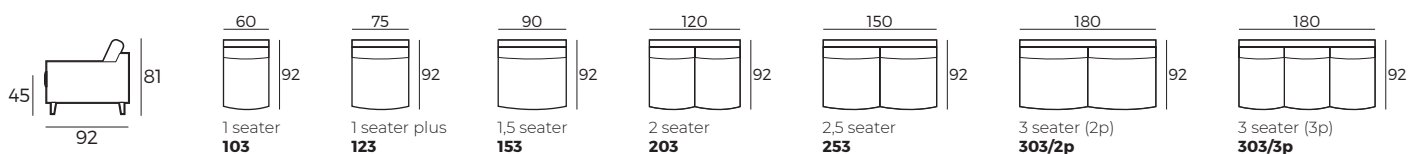

Nordic

Single parts (Measurements with Share armrest)

Scale 1:100

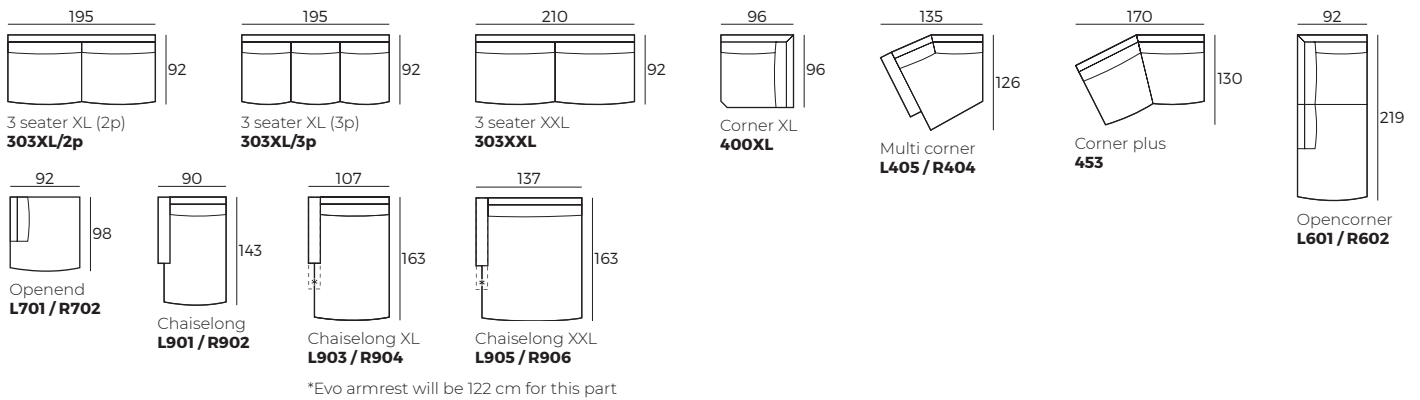

Half sets (Measurements with Share armrest)

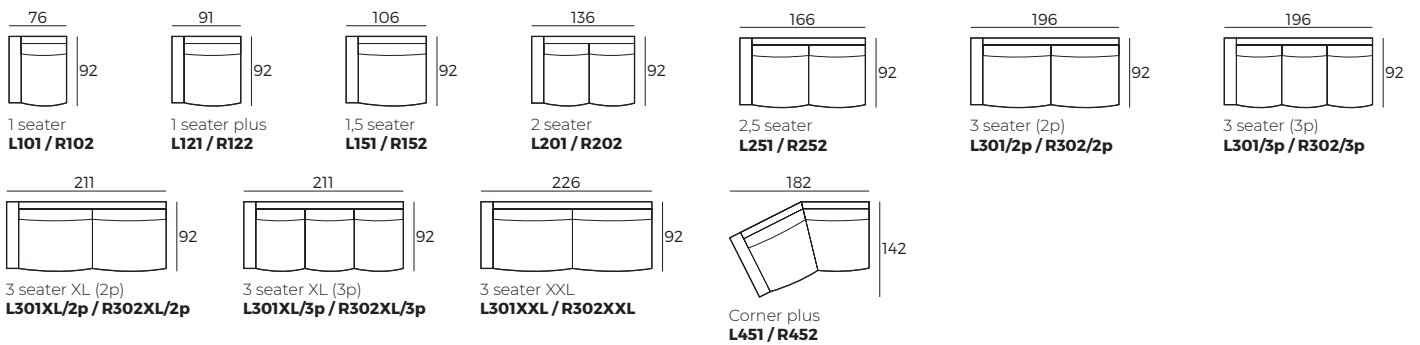

Sets (Measurements with Share armrest)

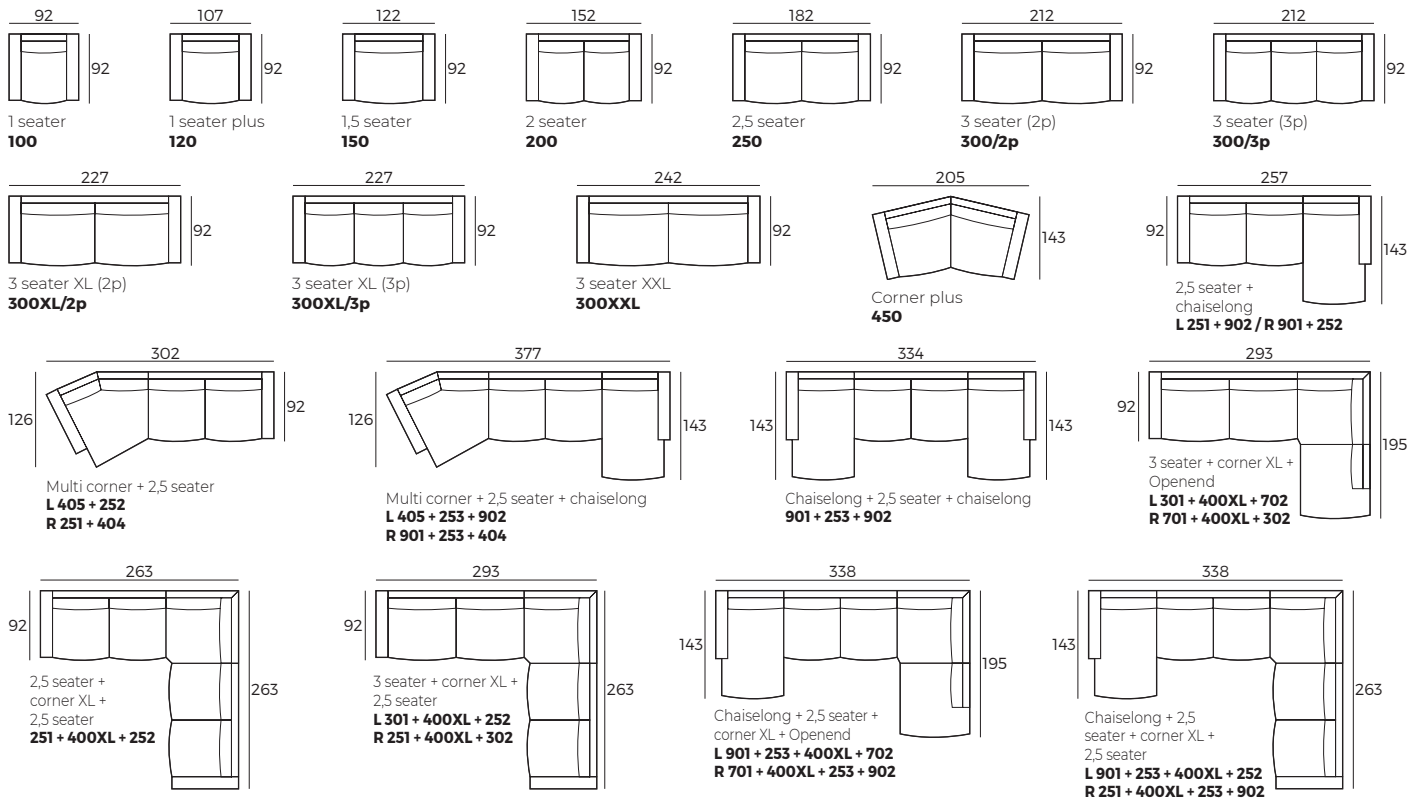

Nordic

Sets (Measurements with Share armrest)

Scale 1:100

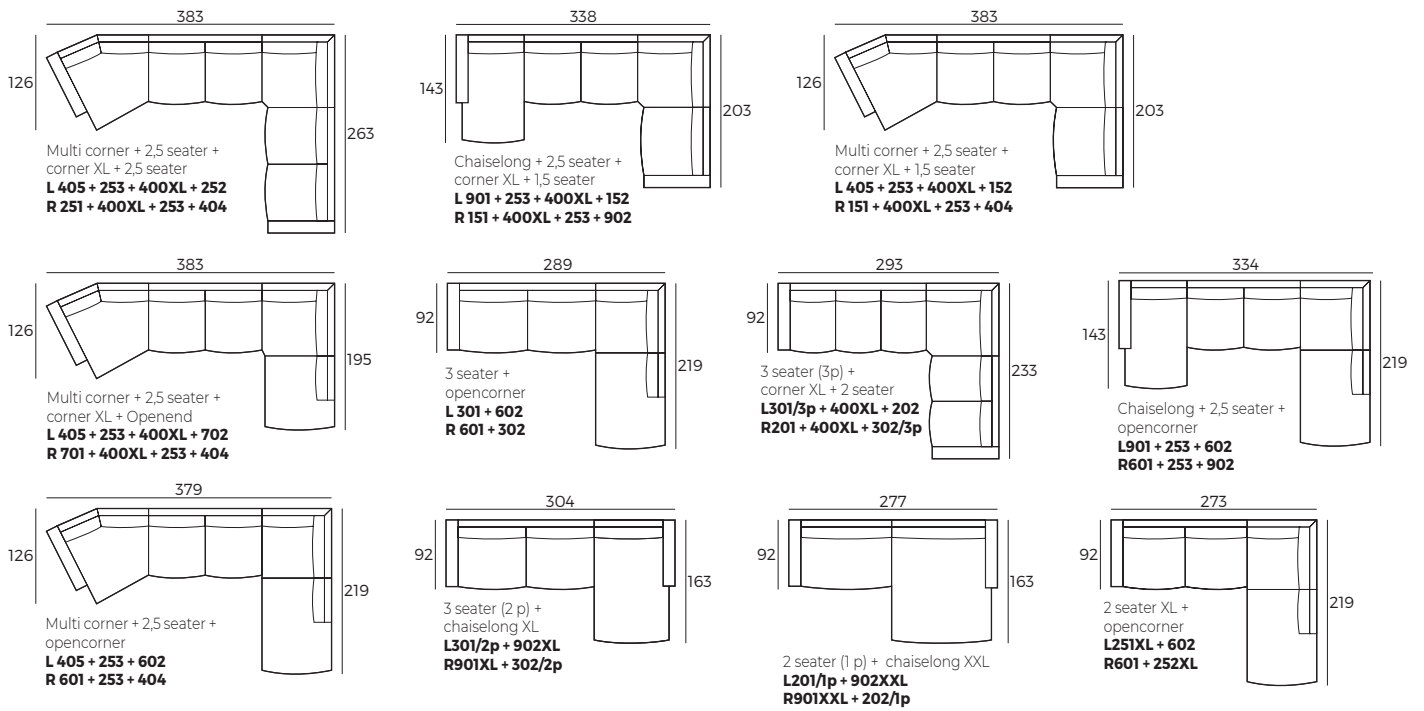

Accessories

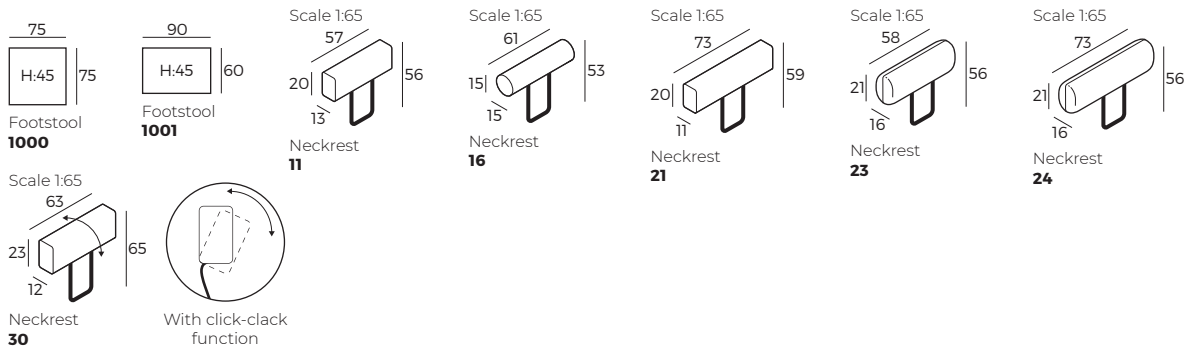

Odense



Odense



Comfort

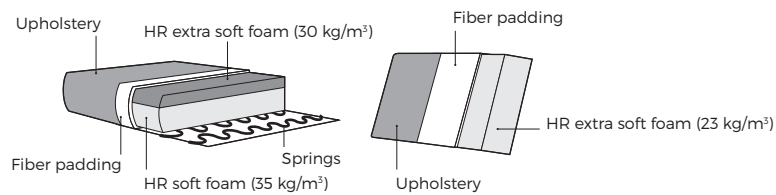

1. Upholstery

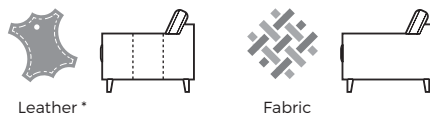

* Leather covers may require more stitches than fabric covers.

2. Legs



IMPORTANT:

Upholstered furniture is handmade using soft materials therefore measurements may vary up to +/- 5 cm.
Parts and sets shown in 2D drawings are left-sided. Parts and sets can be mirrored from left to right.

Single parts

Scale 1:100

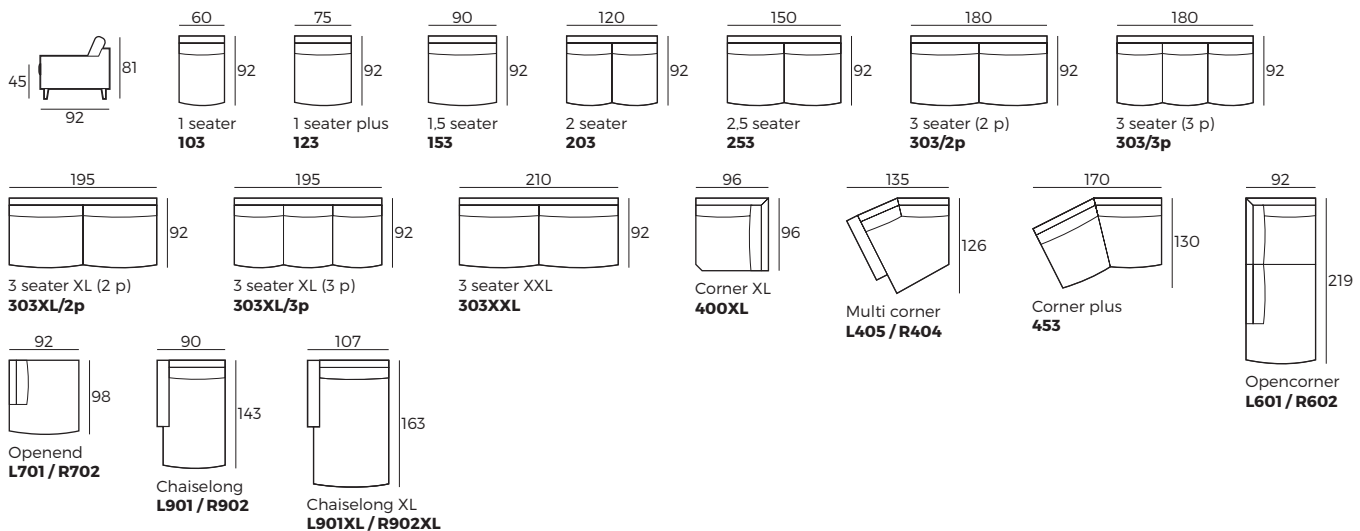

Odense

Half sets

Scale 1:100

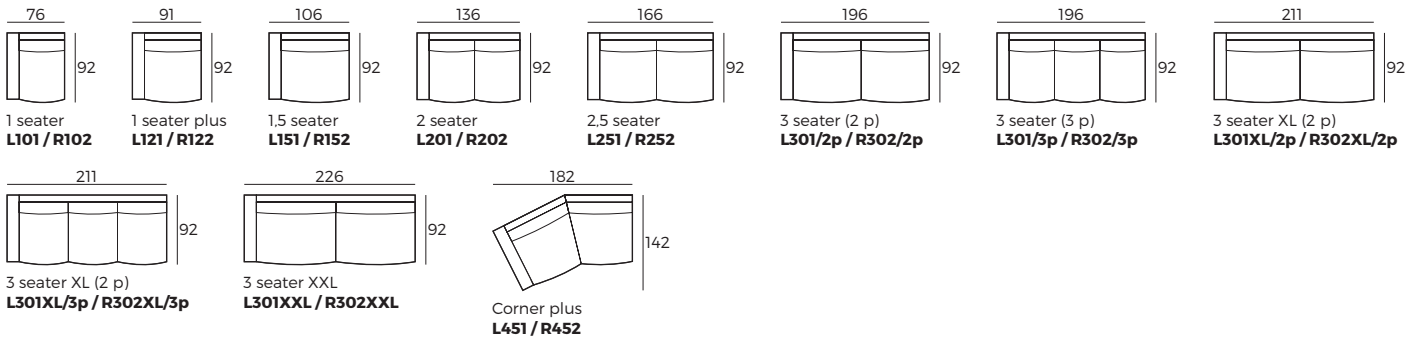

Sets

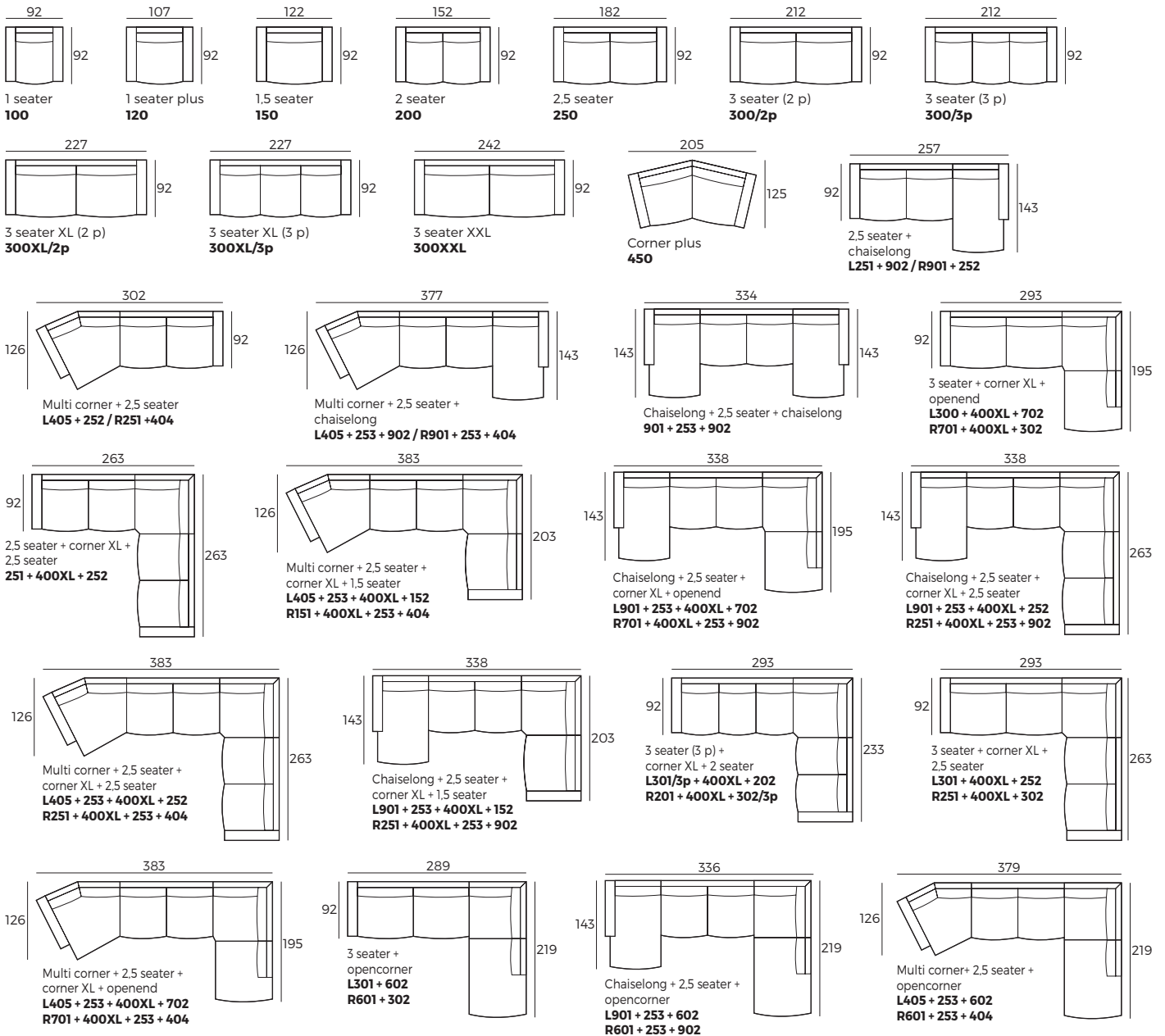

Odense

Accessories

Scale 1:100

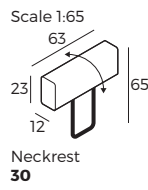
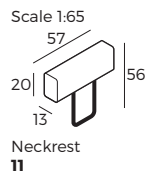
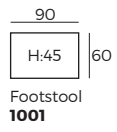
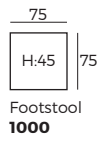

Pony



Pony



Comfort

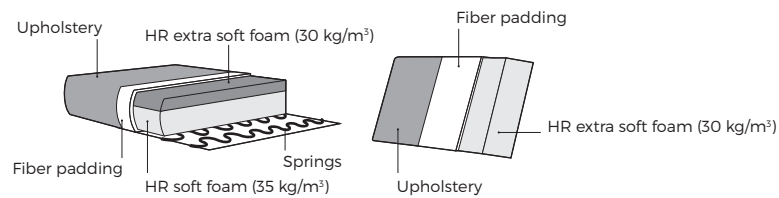

1. Upholstery

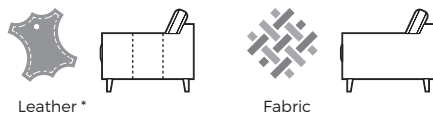

* Leather covers may require more stitches than fabric covers.

2. Headrest & seat type

*Measures with fully opened mechanism

- 1 Manual ↶
- 2 Electrical ⚡

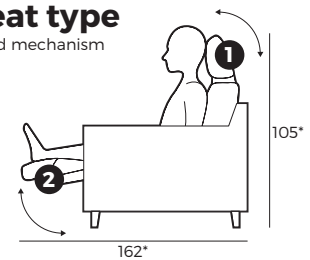

3. Bi-Color option

- Color A
- Color B



4. Legs

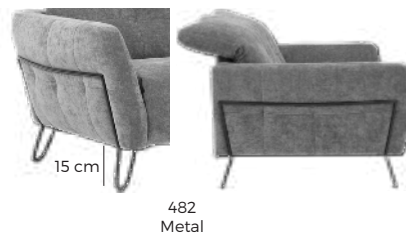

IMPORTANT:

Upholstered furniture is handmade using soft materials therefore measurements may vary up to +/- 5 cm.
Parts and sets shown in 2D drawings are left-sided. Parts and sets can be mirrored from left to right.

Single parts

Scale 1:100

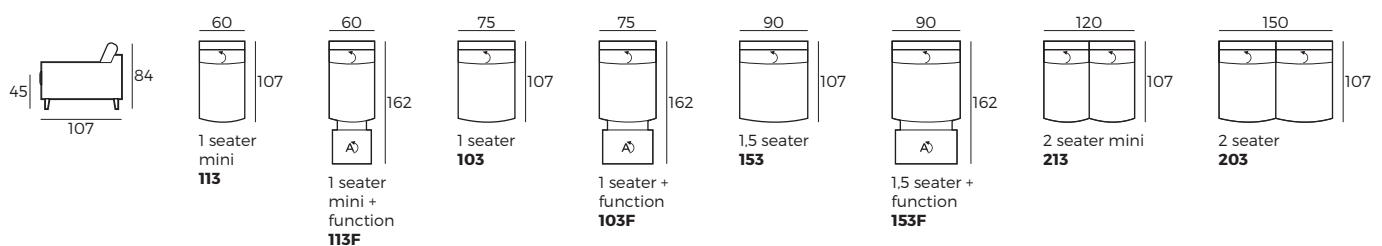

CUSTOM MADE COMFORT

Pony

Scale 1:100

Single parts

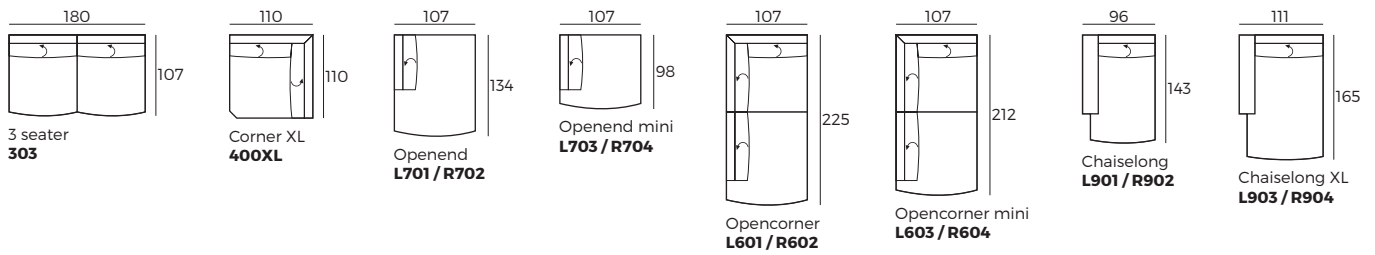

Half sets

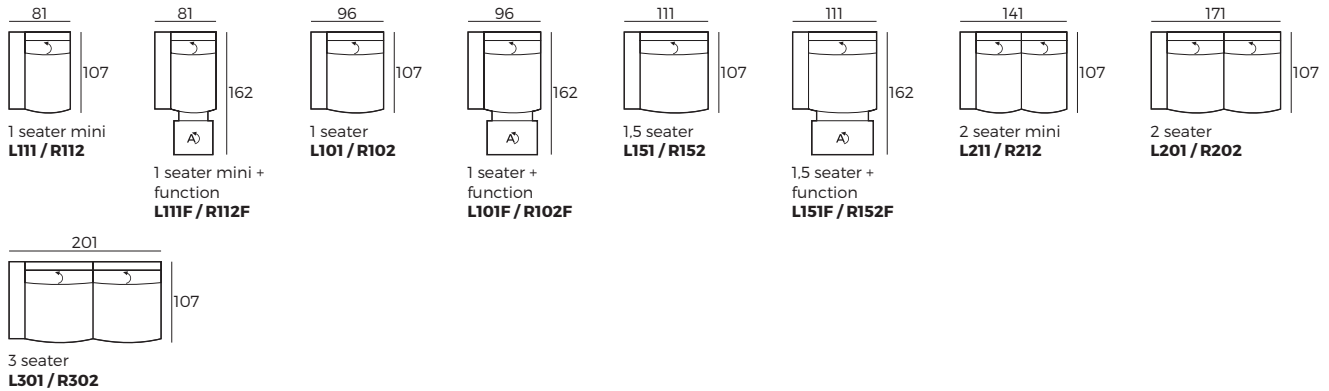

Sets

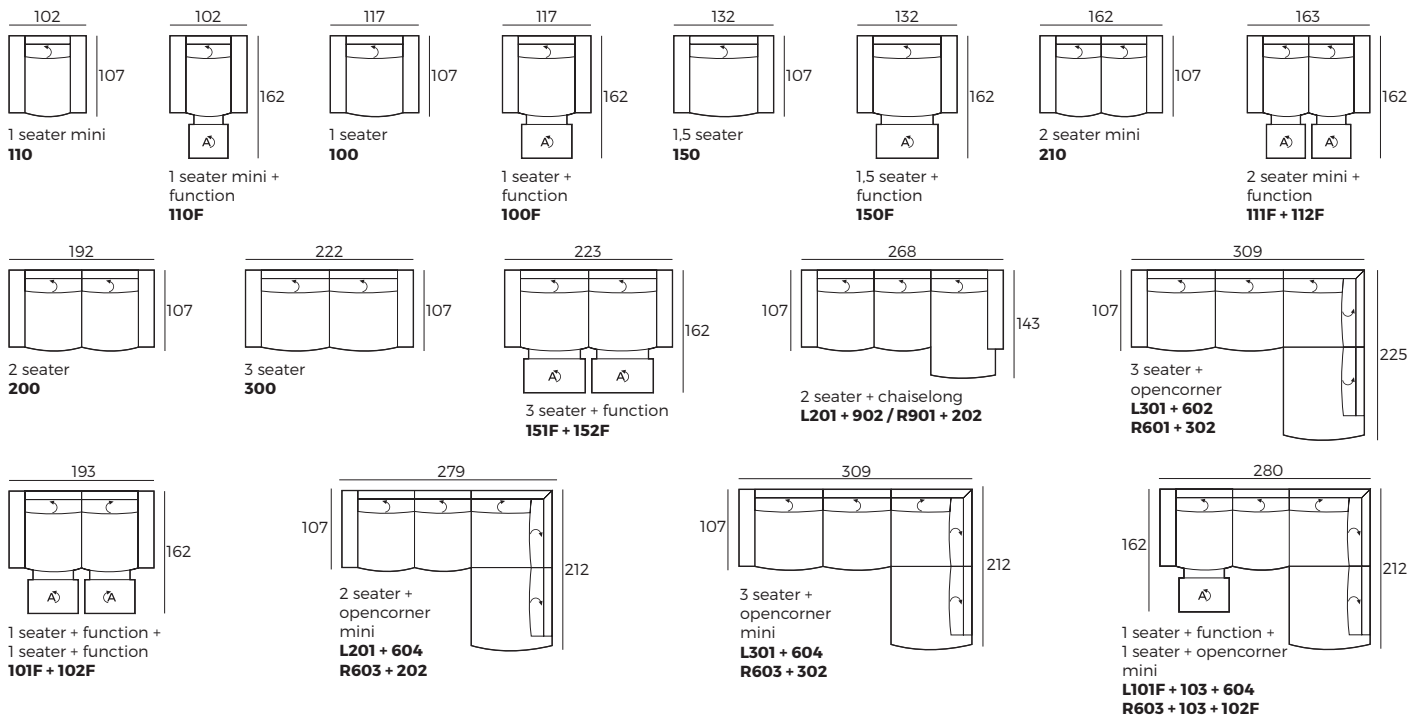

Accessories

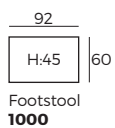

⌋ - manual; Ⓐ - electrical *F - single electric function

Queens



Queens



Comfort

1. Upholstery

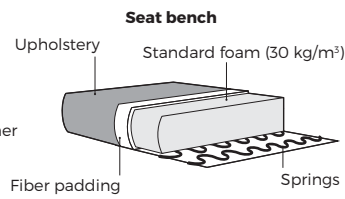
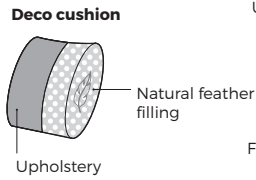
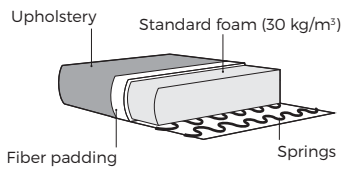

Fabric

2. Bi-Color option

3. Legs

Color A
Color B

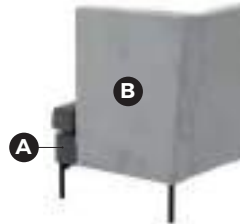
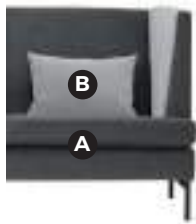

Oiled
Dark chocolate colored lacquer



IMPORTANT:

Upholstered furniture is handmade using soft materials therefore measurements may vary up to +/- 5 cm.

Measurements

Scale 1:50

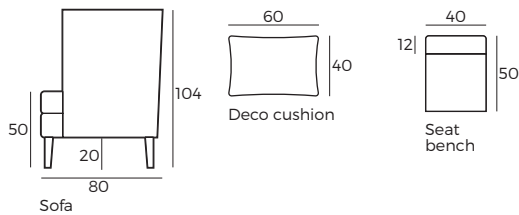

Sets

Scale 1:100

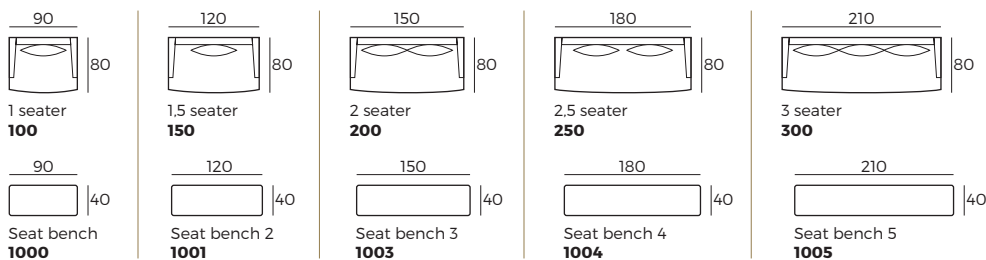

CUSTOM MADE COMFORT

Rolf



Rolf



Comfort

1. Upholstery

2. Legs

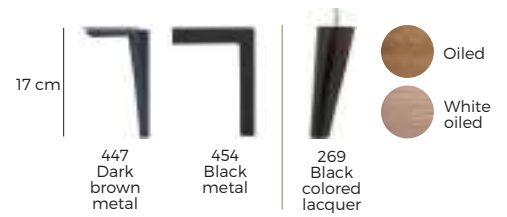
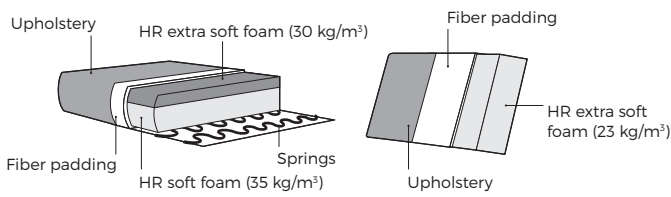

IMPORTANT:

Upholstered furniture is handmade using soft materials therefore measurements may vary up to +/- 5 cm.
Parts and sets shown in 2D drawings are left-sided. Parts and sets can be mirrored from left to right.

Single parts

Scale 1:100

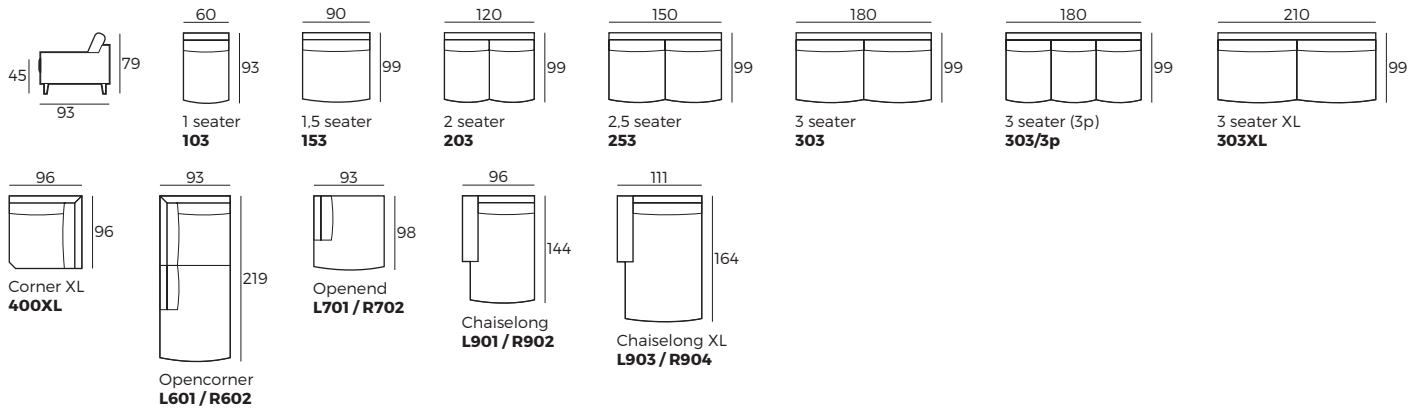

Half sets

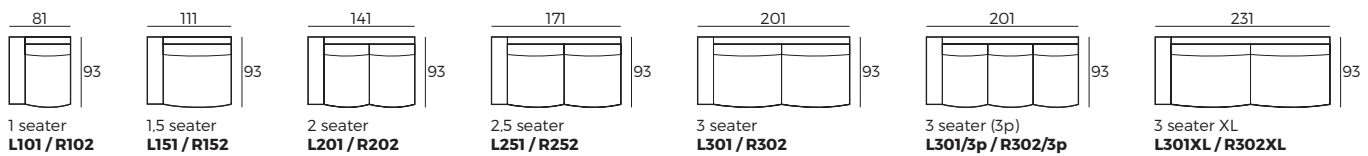

Sets

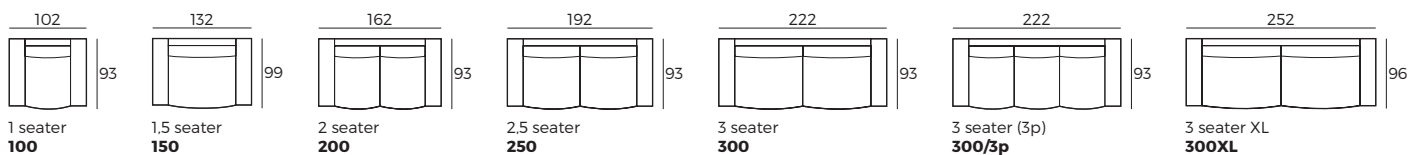

CUSTOM MADE COMFORT

Rolf

Sets

Scale 1:100

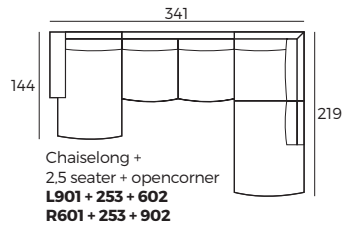
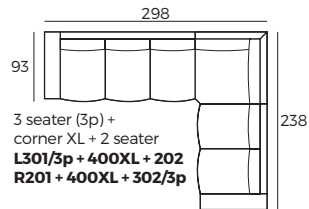
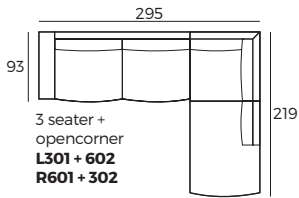
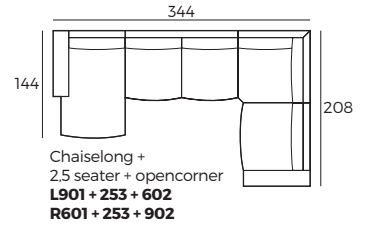
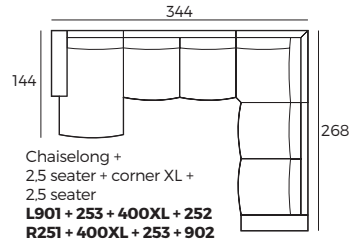
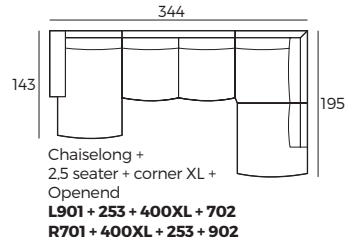
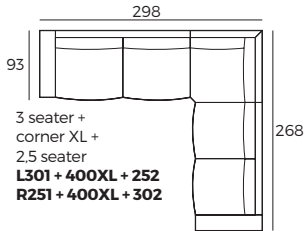
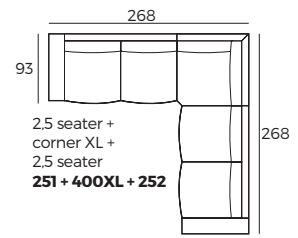
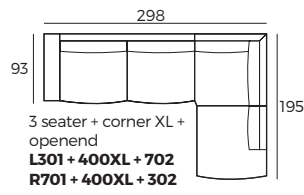
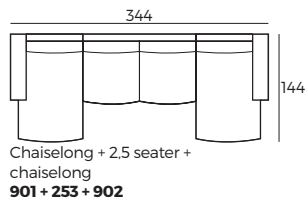
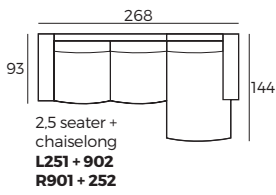

Accessories

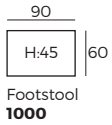

Sally



Sally



Comfort

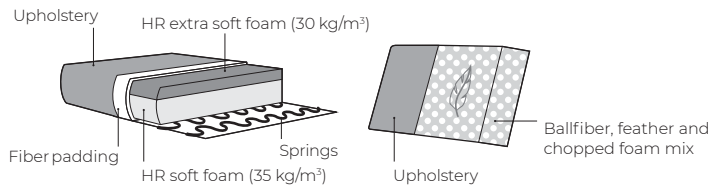

1. Upholstery



Fabric

2. Legs



122 Plastic

IMPORTANT:

Upholstered furniture is handmade using soft materials therefore measurements may vary up to **+/- 5 cm**.
Parts and sets shown in 2D drawings are left-sided. Parts and sets can be mirrored from left to right.

Single parts

Scale 1:100

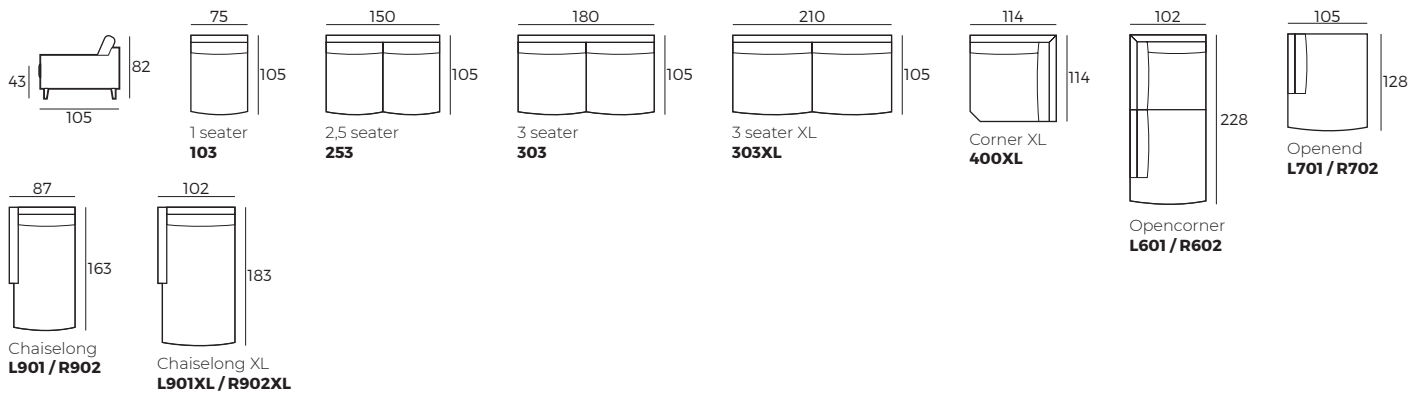

Half sets

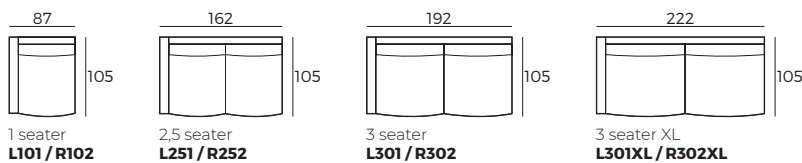

Sets

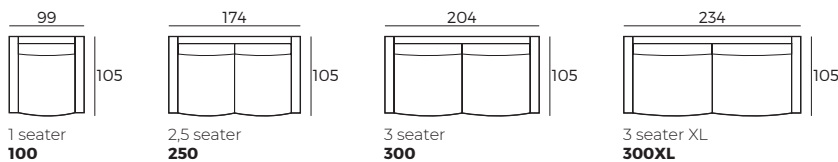

Accessories

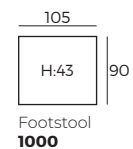

San Francisco



San Francisco



Comfort

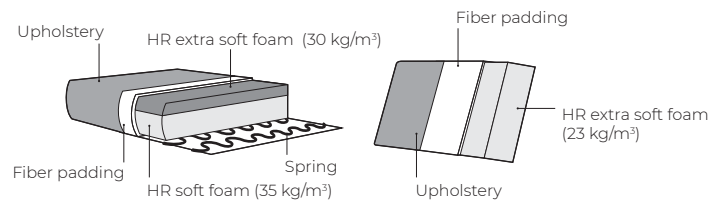

1. Upholstery



* Leather covers may require more stitches than fabric covers.

2. Armrest



Classy
W 17 x D 93 x H 54

Funk
W 31 x D 93 x H 38

Armrest Funk function



3. Legs

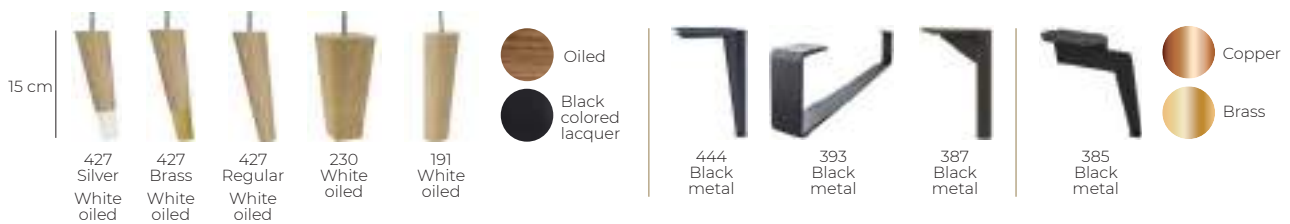

IMPORTANT:

Upholstered furniture is handmade using soft materials therefore measurements may vary up to +/- 5 cm.
Parts and sets shown in 2D drawings are left-sided. Parts and sets can be mirrored from left to right.

Single parts (Measurements with Funk armrest)

Scale 1:100

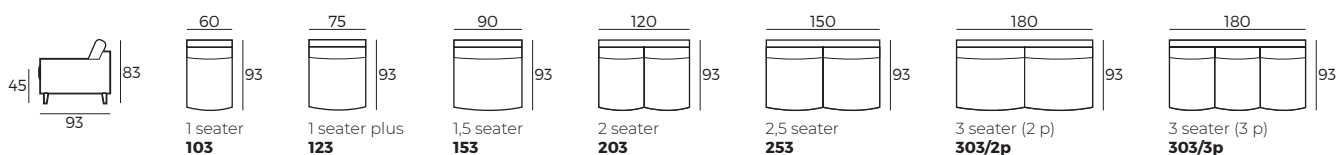

San Francisco

Single parts (Measurements with Funk armrest)

Scale 1:100

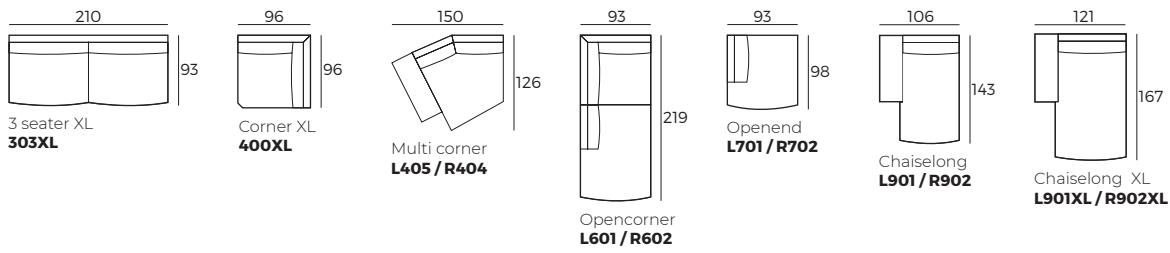

Half sets (Measurements with Funk armrest)

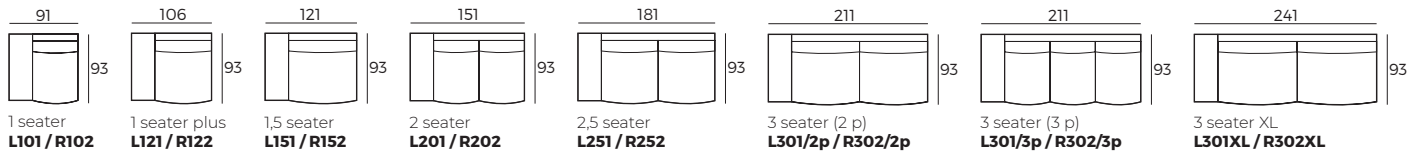

Sets (Measurements with Funk armrest)

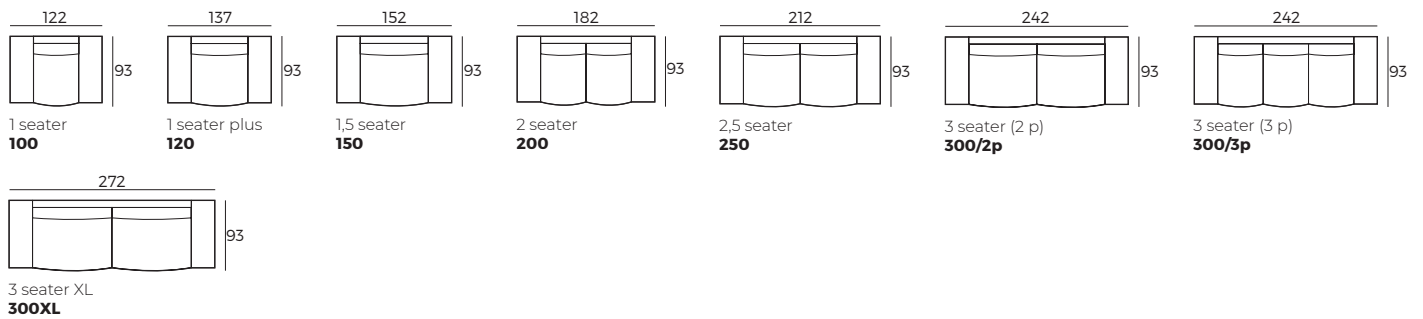

Accessories

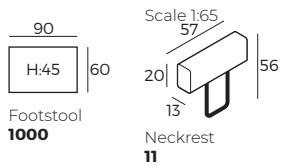

Sanna



Sanna



Comfort

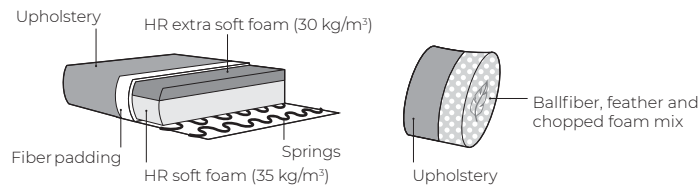

1. Upholstery



* Leather and fabric upholstery contains the same number of stitches.

2. Legs



IMPORTANT:

Upholstered furniture is handmade using soft materials therefore measurements may vary up to +/- 5 cm.
Parts and sets shown in 2D drawings are left-sided. Parts and sets can be mirrored from left to right.

Single parts

Scale 1:100

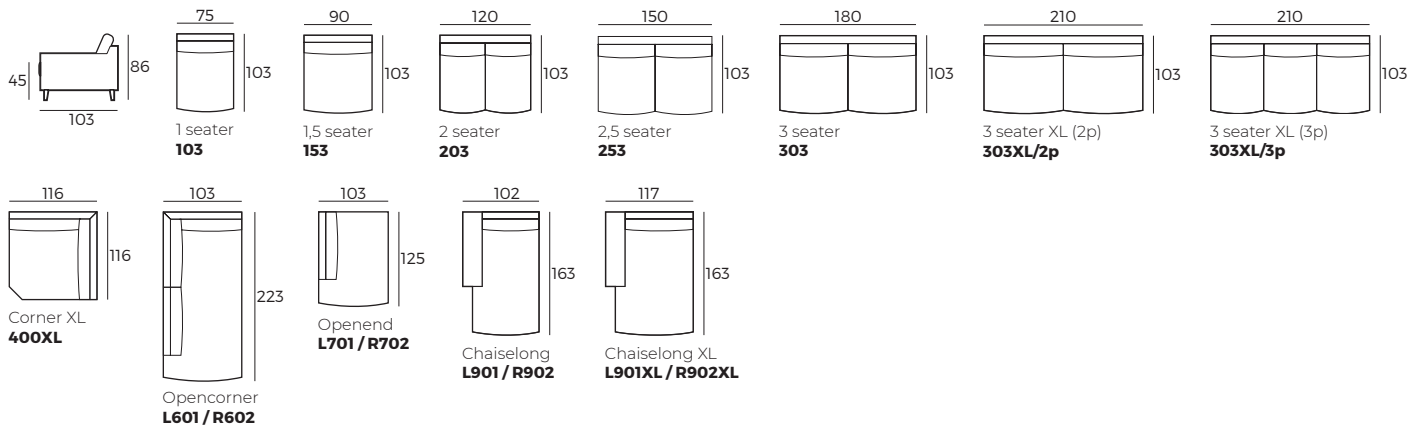

Sanna

Half sets

Scale 1:100

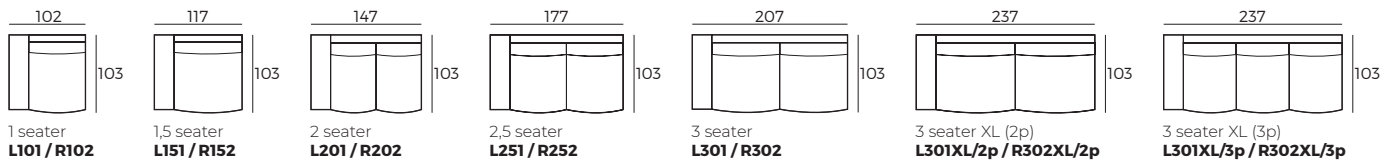

Sets

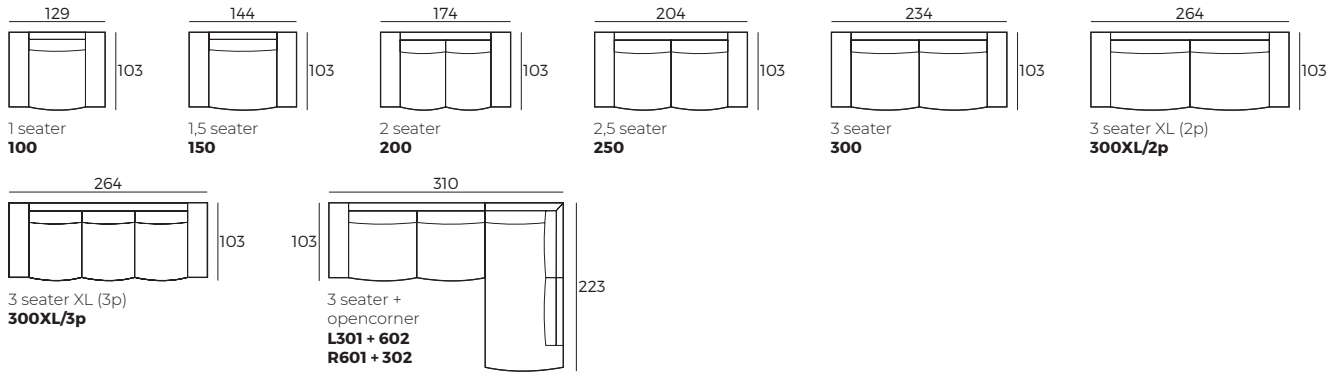

Accessories

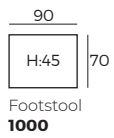

Scandy



Scandy



Comfort

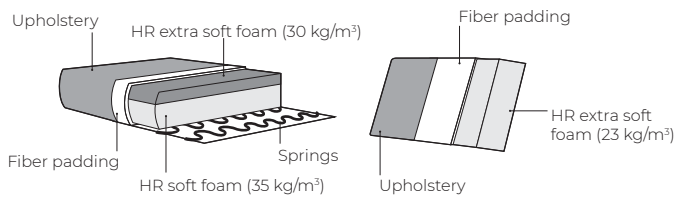

1. Upholstery

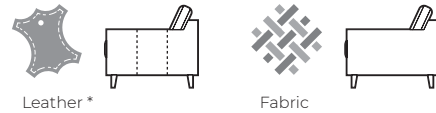

* Leather covers may require more stitches than fabric covers.

2. Armrests



Omega W 3 x D 90 x H 53 **Style** W 9 x D 90 x H 53 **Slim** W 9 x D 90 x H 53 **Fancy** W 11 x D 90 x H 53 **Less** W 12 x D 90 x H 48 **Liv** W 12/20 x D 90 x H 51 **Share** W 16 x D 90 x H 48 **Duo** W 20 x D 90 x H 53 **Evo** W 20 x D 90 x H 49

3. Legs

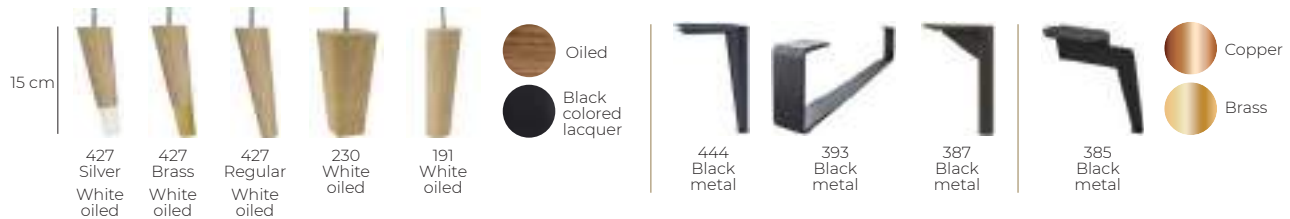

IMPORTANT:

Upholstered furniture is handmade using soft materials therefore measurements may vary up to **+/- 5 cm**;
Parts and sets shown in 2D drawings are left-sided. Parts and sets can be mirrored from left to right.

Single parts (Measurements with Share armrest)

Scale 1:100

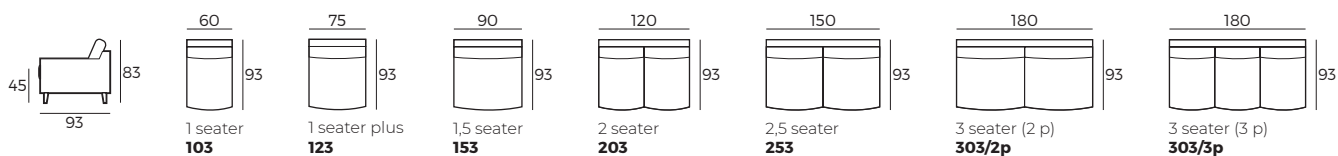

Scandy

Single parts (Measurements with Share armrest)

Scale 1:100

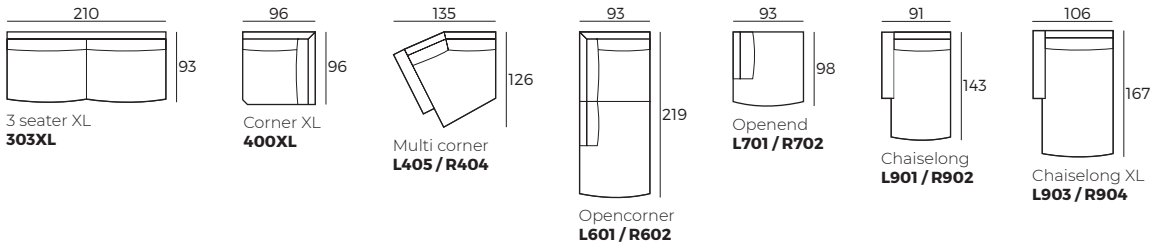

Half sets (Measurements with Share armrest)

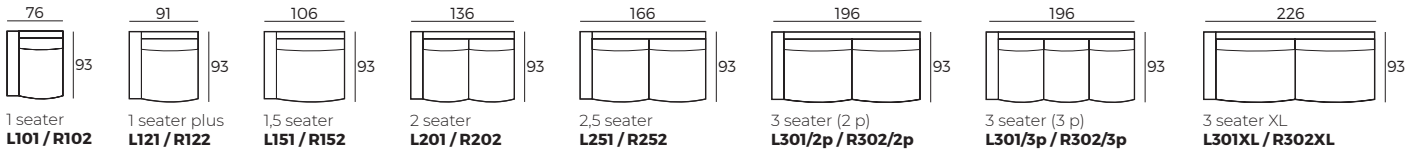

Sets (Measurements with Share armrest)

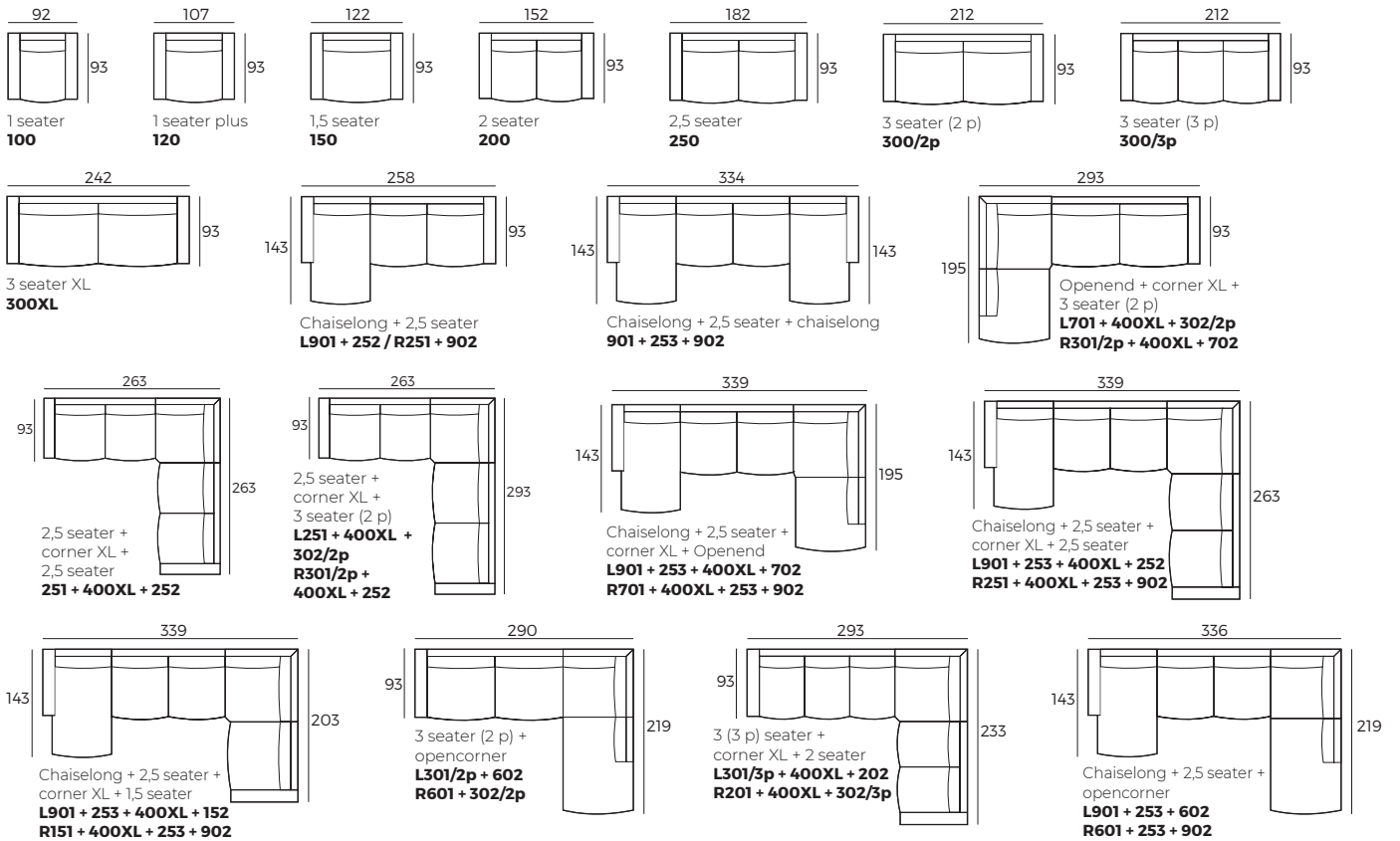

Accessories

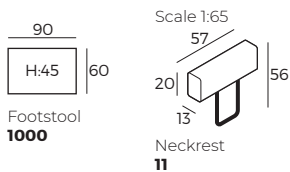

Selena



Selena



Comfort

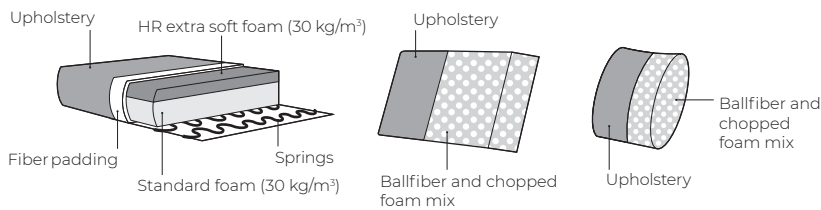

1. Upholstery



* Leather covers may require more stitches than fabric covers.

2. Armrests

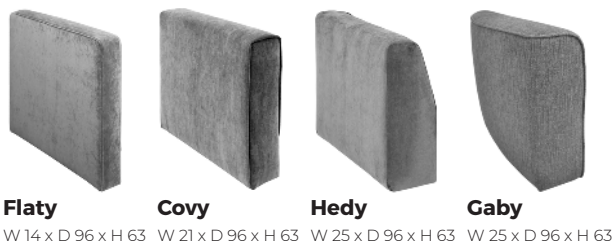

W 14 x D 96 x H 63 W 21 x D 96 x H 63 W 25 x D 96 x H 63 W 25 x D 96 x H 63

3. Bi-Color option

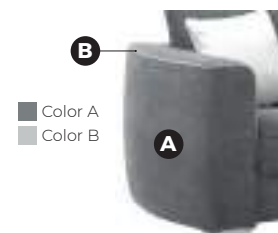

4. Choose pillows

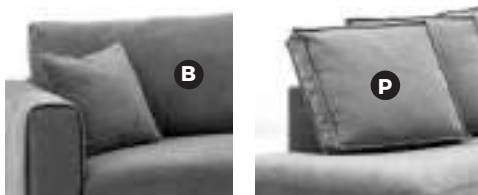

Pillow **B**

Pillow **P***

* Only fabric option for this pillow.

5. Legs



IMPORTANT:

Upholstered furniture is handmade using soft materials therefore measurements may vary up to +/- 5 cm.
Parts and sets shown in 2D drawings are left-sided. Parts and sets can be mirrored from left to right.

Single parts (Measurements with Gaby armrest)

Scale 1:100

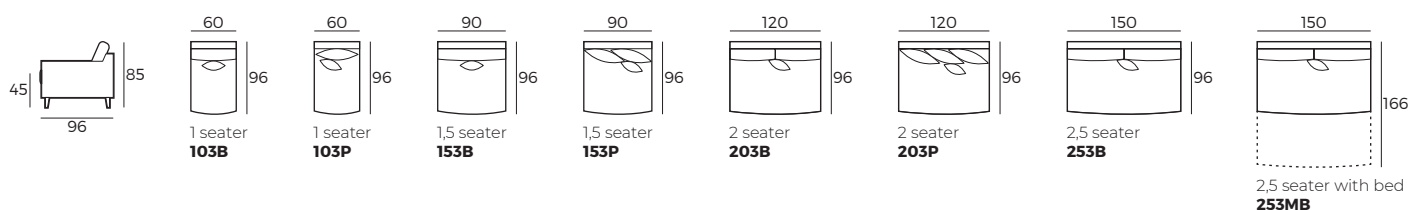

CUSTOM MADE COMFORT

Selena

Single parts (Measurements with Gaby armrest)

Scale 1:100

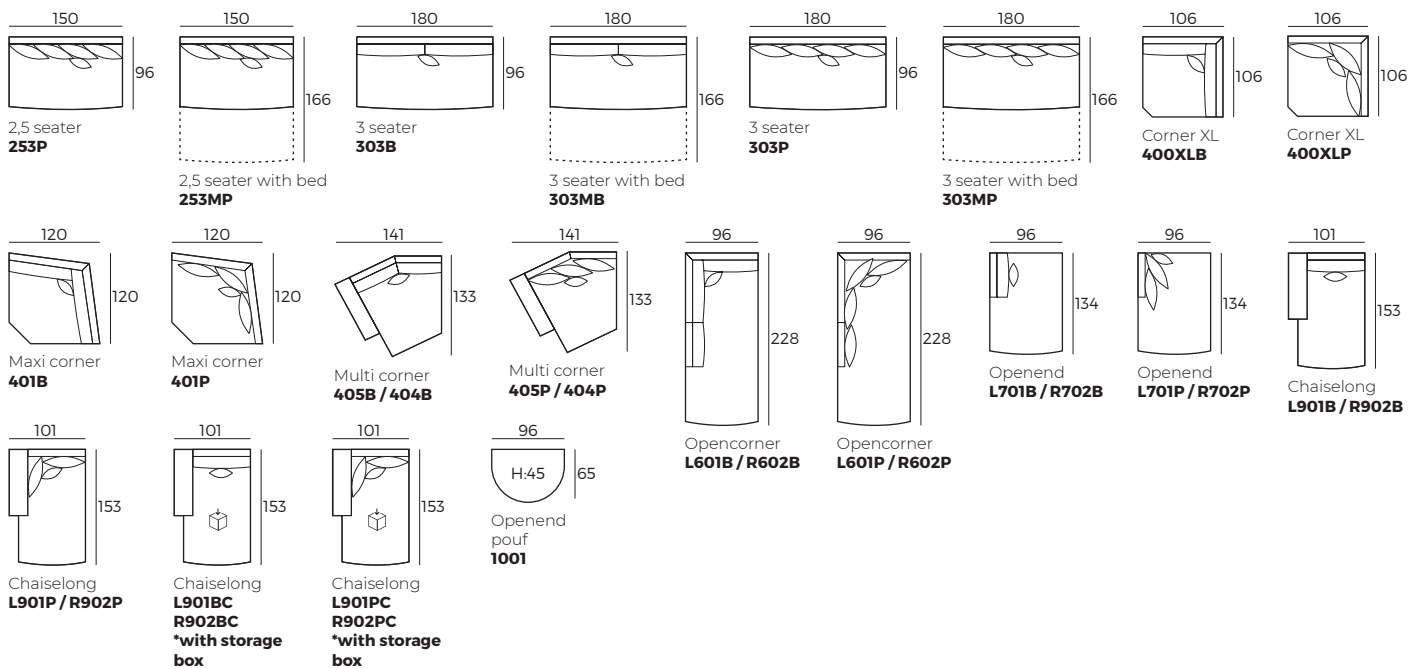

Half-sets (Measurements with Gaby armrest)

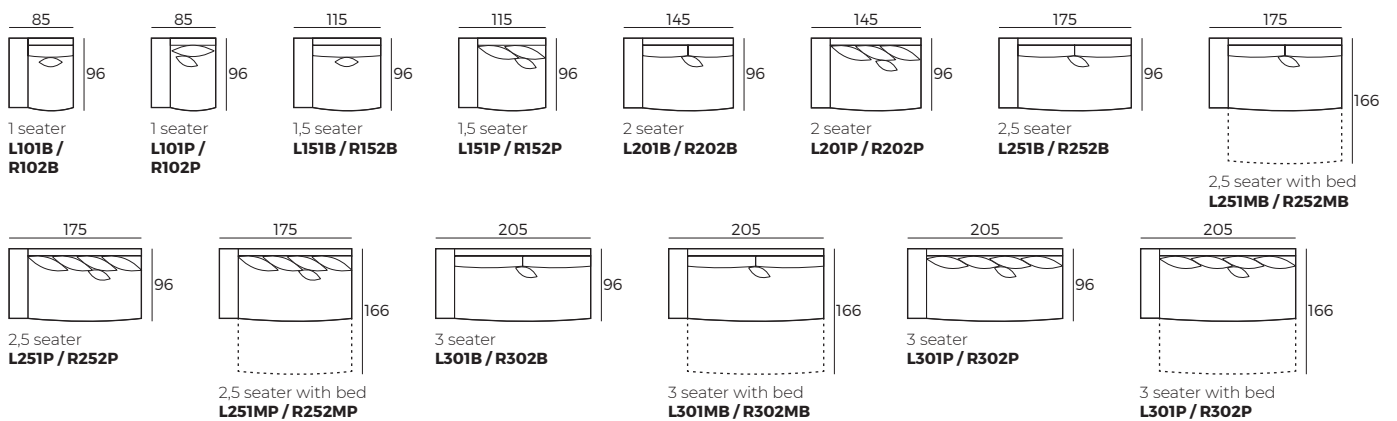

Sets (Measurements with Gaby armrest)

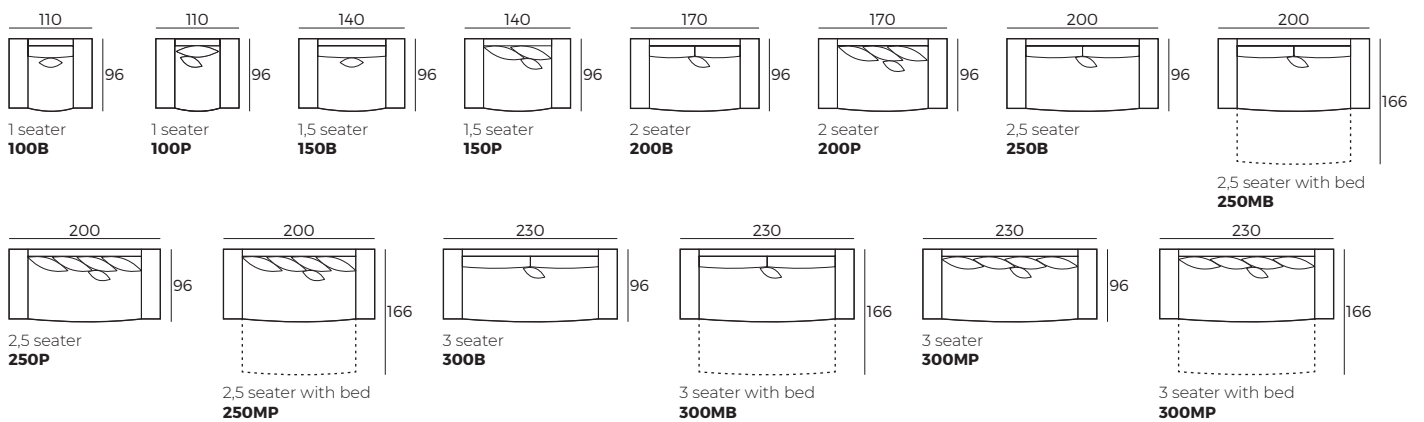

Accessories

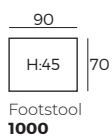

Shiny



Shiny



Comfort

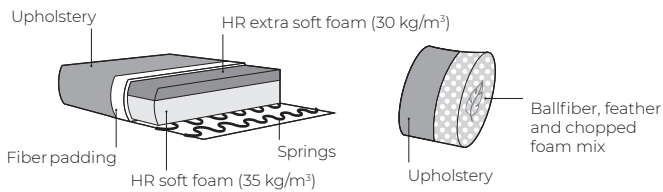

1. Upholstery



* Leather covers may require more stitches than fabric covers.

2. Bi-Color option

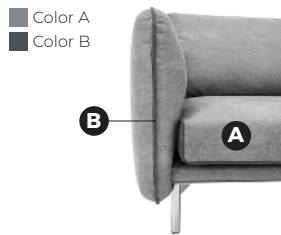

2. Legs

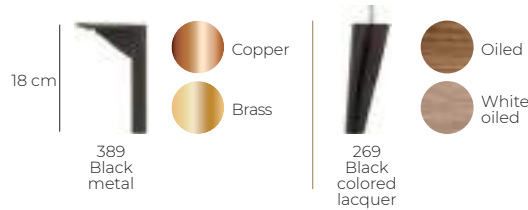

IMPORTANT:

Upholstered furniture is handmade using soft materials therefore measurements may vary up to +/- 5 cm.
Parts and sets shown in 2D drawings are left-sided. Parts and sets can be mirrored from left to right.

Single parts

Scale 1:100

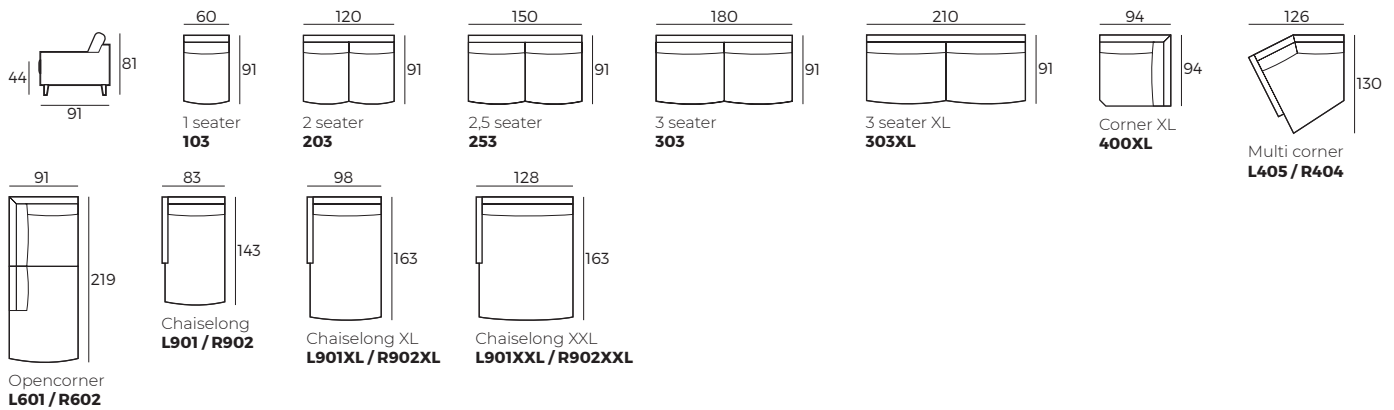

Shiny

Scale 1:100

Half sets



Sets

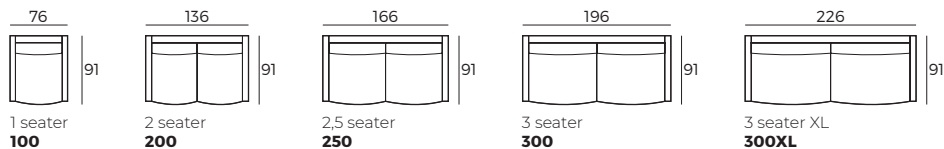

Accessories

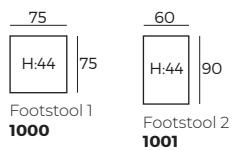

Signature



Signature



Comfort

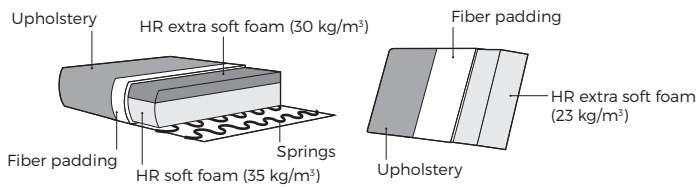

1. Upholstery



* Leather covers may require more stitches than fabric covers.

2. Headrest type

*Measures with fully opened mechanism

1 Manual ↻

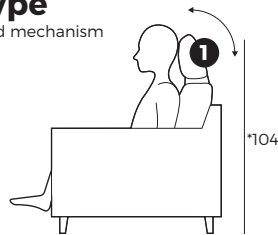

3. Movable back

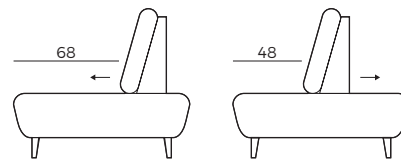

4. Bi-Color option

■ Color A
■ Color B

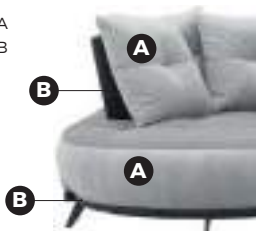

5. Armrest



W 19 x D 101 x H 53

6. Legs



394
Black
metal

IMPORTANT:

Upholstered furniture is handmade using soft materials therefore measurements may vary up to +/- 5 cm.
Parts and sets shown in 2D drawings are left-sided. Parts and sets can be mirrored from left to right.

Single parts

Scale 1:100

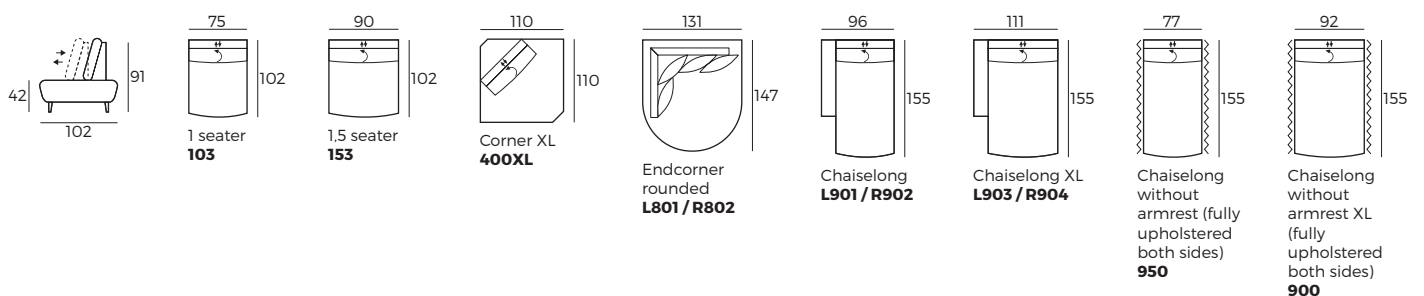

CUSTOM MADE COMFORT

Signature

Sets

Scale 1:100

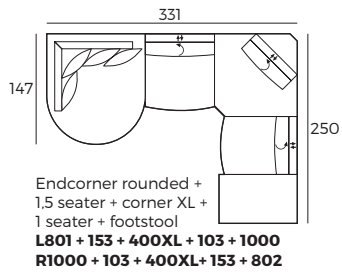

Accessories

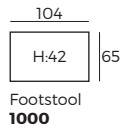

↷ - manual: ↕ - movable back seat depth

Sky



Sky



Comfort

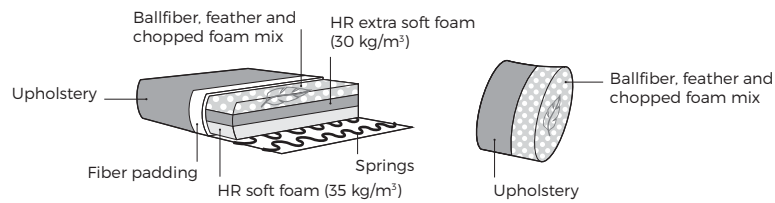

1. Upholstery



2. Legs



IMPORTANT:

Upholstered furniture is handmade using soft materials therefore measurements may vary up to +/- 5 cm.
Parts and sets shown in 2D drawings are left-sided. Parts and sets can be mirrored from left to right.

Single parts

Scale 1:100

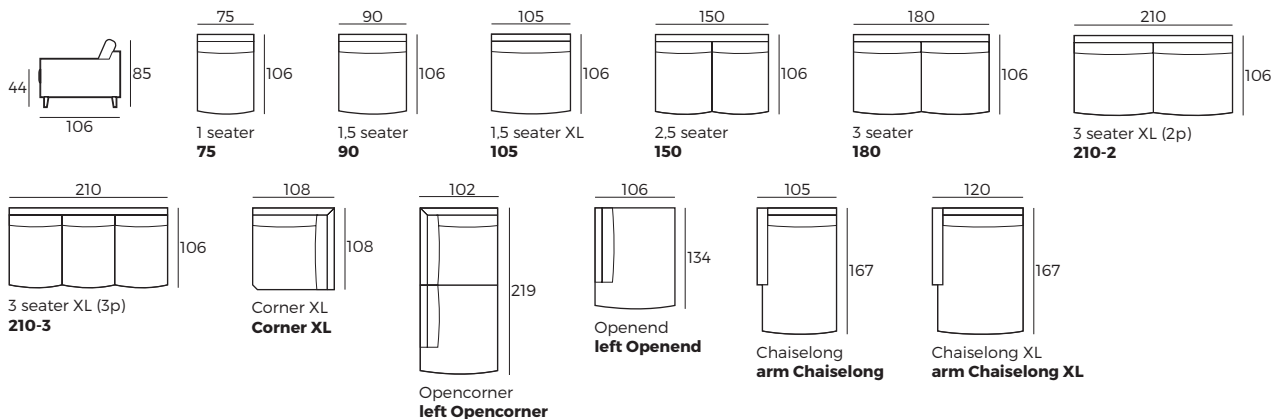

Sky

Half sets

Scale 1:100

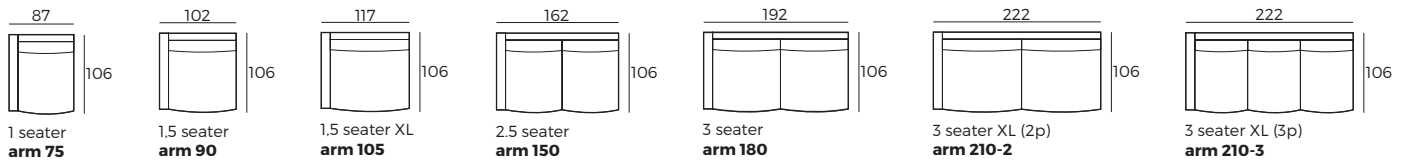

Sets

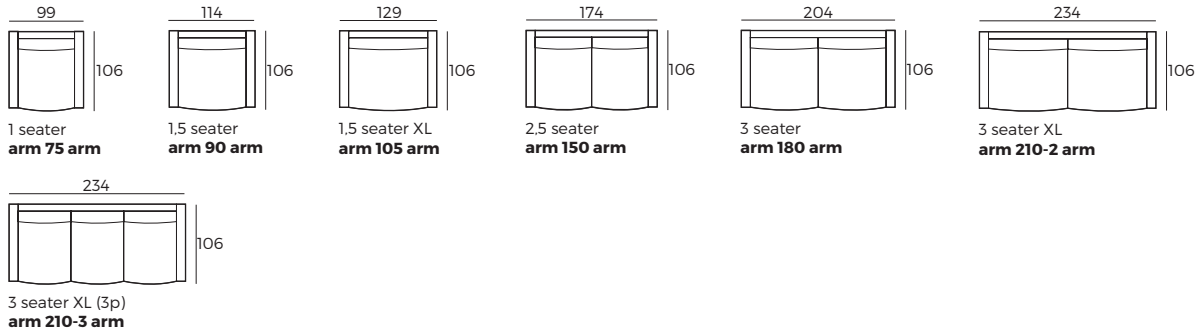

Accessories

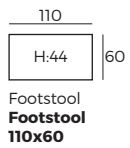

Slim



Slim



Comfort

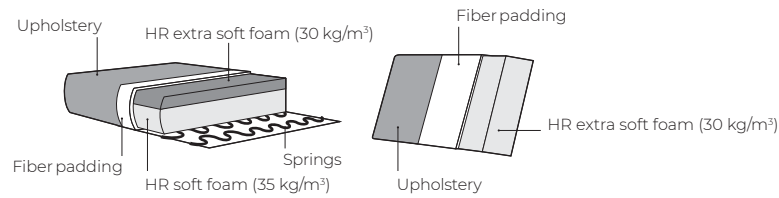

1. Upholstery



* Leather covers may require more stitches than fabric covers.

2. Headrest & seat type

*Measures with fully opened mechanism

- 1 Manual ↶
- 2 Electrical ⚡

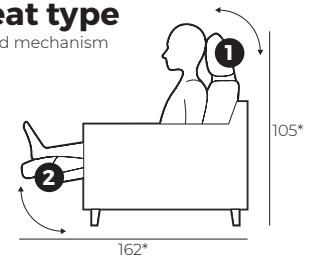

3. Bi-Color option

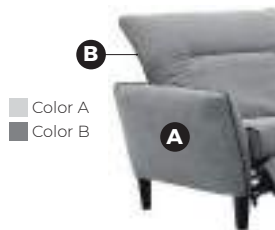

4. Legs

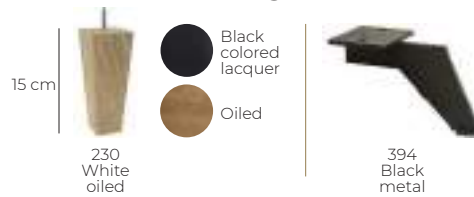

IMPORTANT:

Upholstered furniture is handmade using soft materials therefore measurements may vary up to +/- 5 cm.
Parts and sets shown in 2D drawings are left-sided. Parts and sets can be mirrored from left to right.

Single parts

Scale 1:100

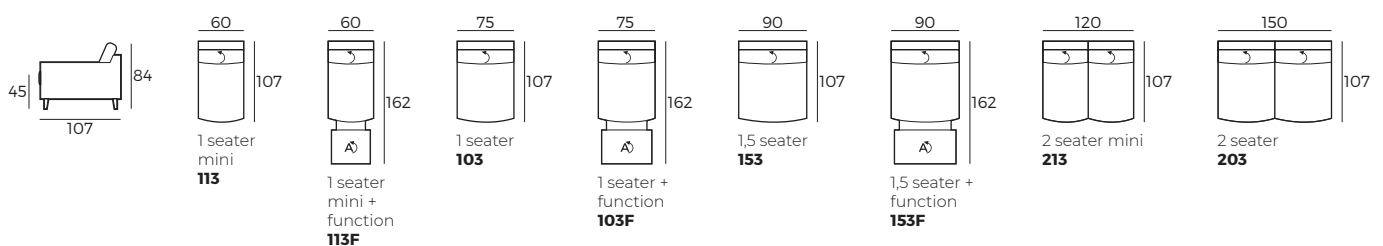

CUSTOM MADE COMFORT

Slim

Scale 1:100

Single parts

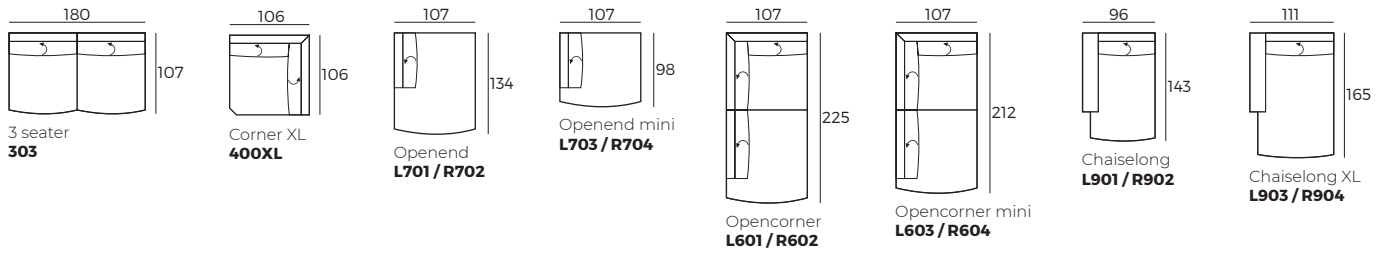

Half sets

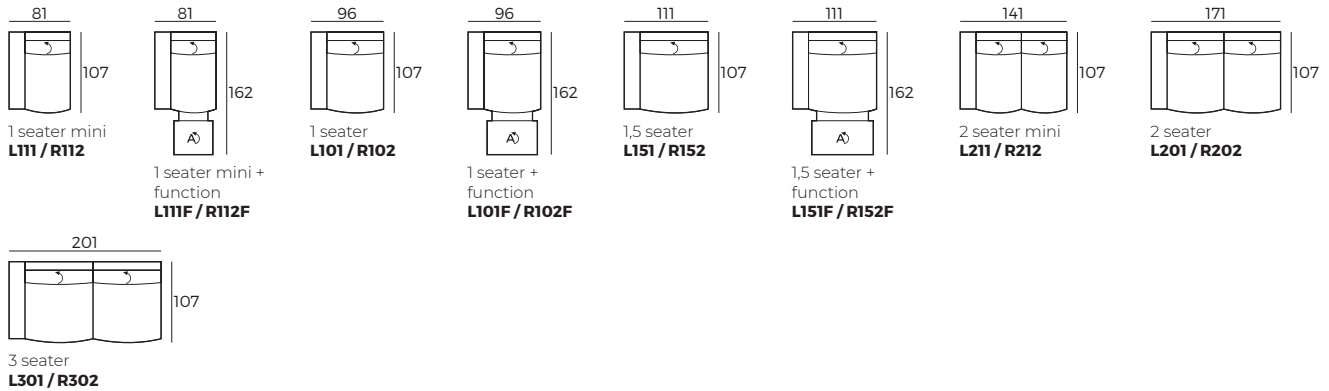

Sets

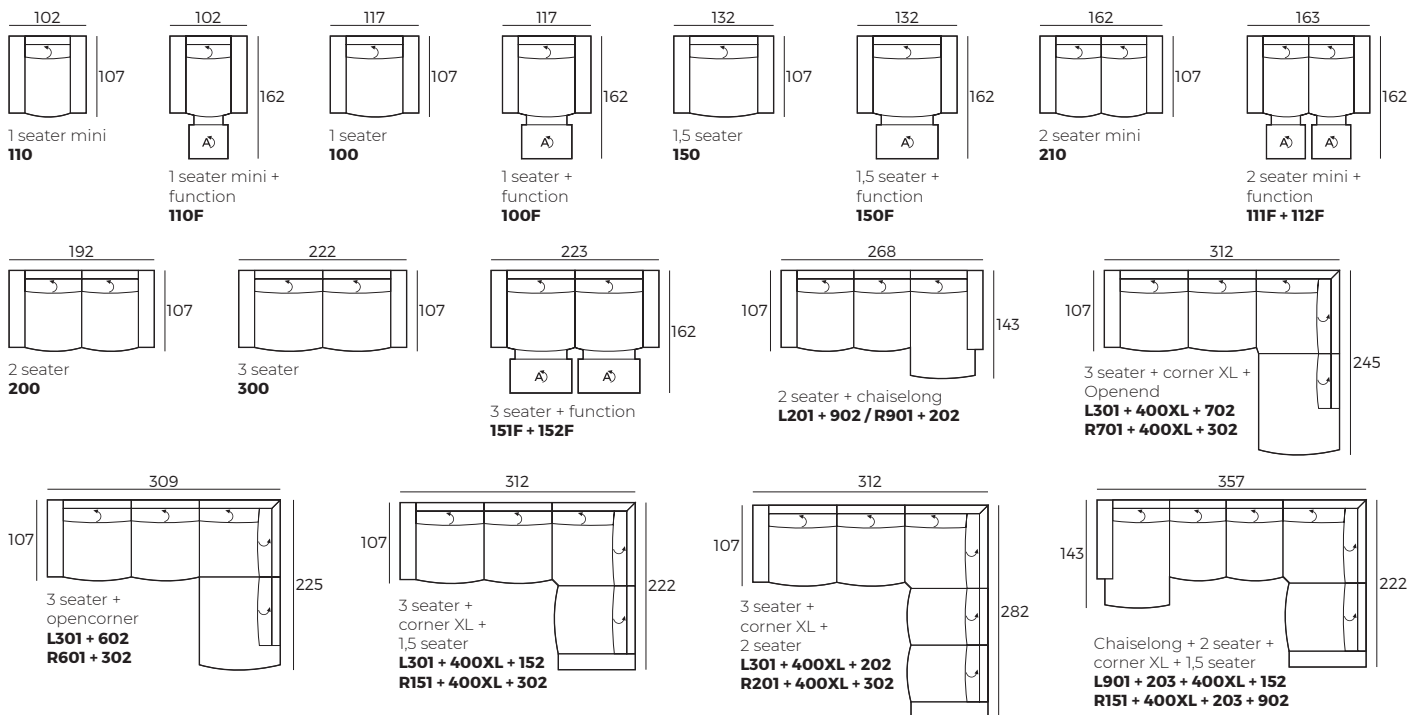

Accessories

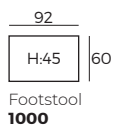

↶ - manual; ↷ - electrical *F - single electric function

Smile



Smile



Comfort

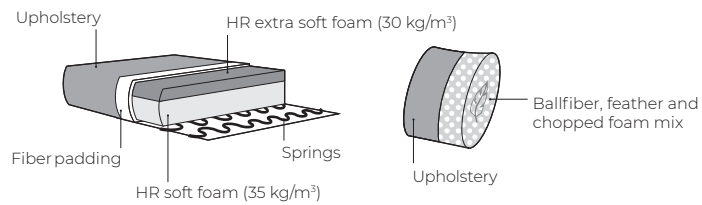

1. Upholstery



* Leather covers may require more stitches than fabric covers.

2. Legs



IMPORTANT:

Upholstered furniture is handmade using soft materials therefore measurements may vary up to +/- 5 cm.
Parts and sets shown in 2D drawings are left-sided. Parts and sets can be mirrored from left to right.

Single parts

Scale 1:100

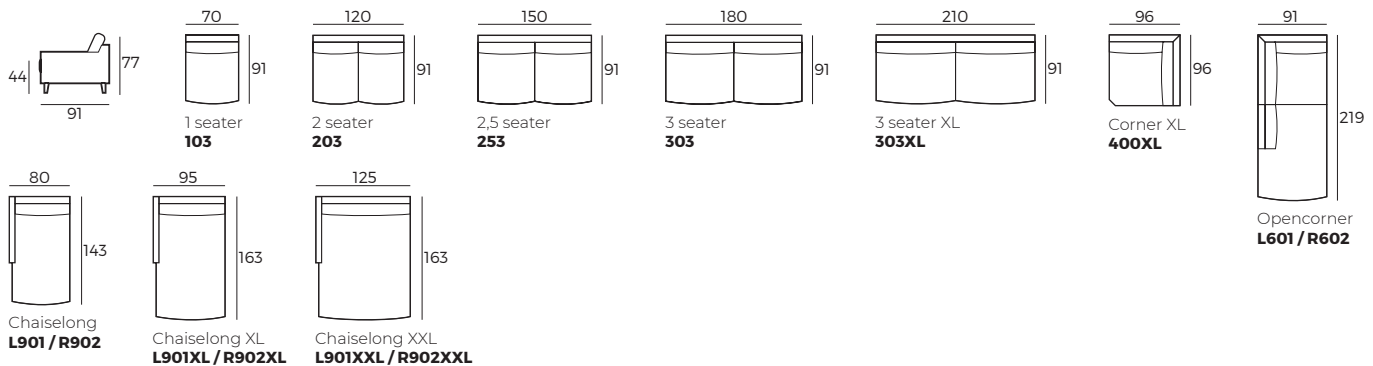

Smile

Scale 1:100

Half sets



Sets

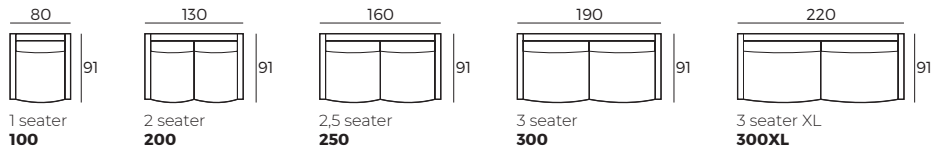

Accessories

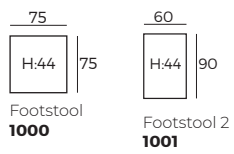

Spring



Spring



Comfort

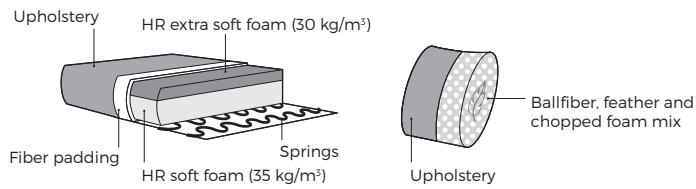

1. Upholstery



Fabric

2. Choose pillows

Multi corner

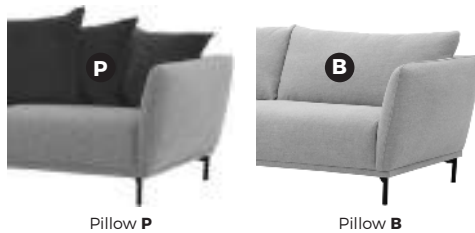

Pillow **P**

Pillow **B**

3. Legs

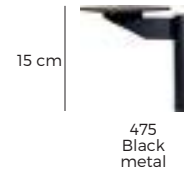

IMPORTANT:

Upholstered furniture is handmade using soft materials therefore measurements may vary up to +/- 5 cm.
Parts and sets shown in 2D drawings are left-sided. Parts and sets can be mirrored from left to right.

Single parts

Scale 1:100

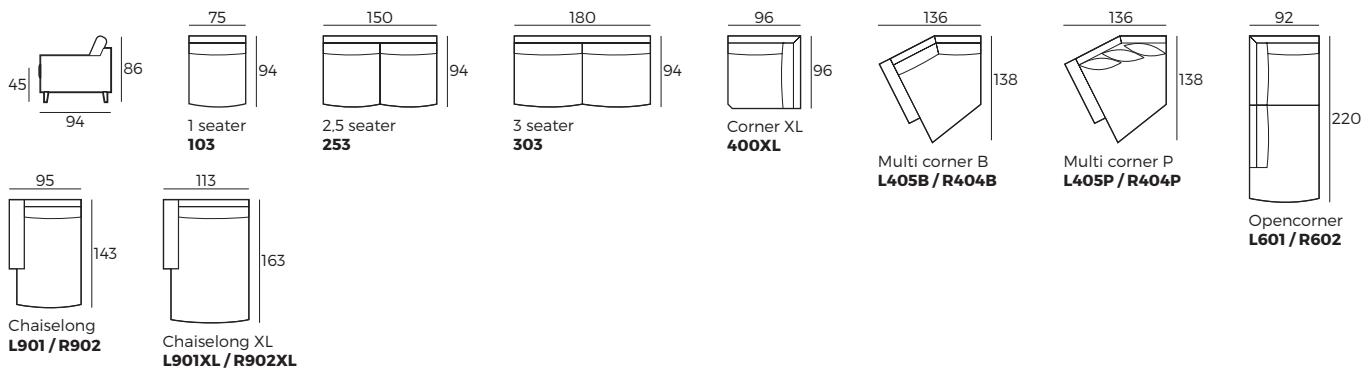

Half sets

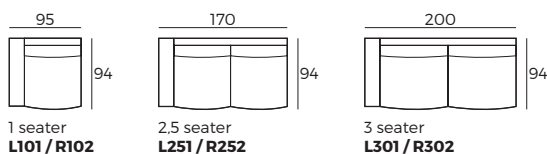

CUSTOM MADE COMFORT

Spring

Sets

Scale 1:100

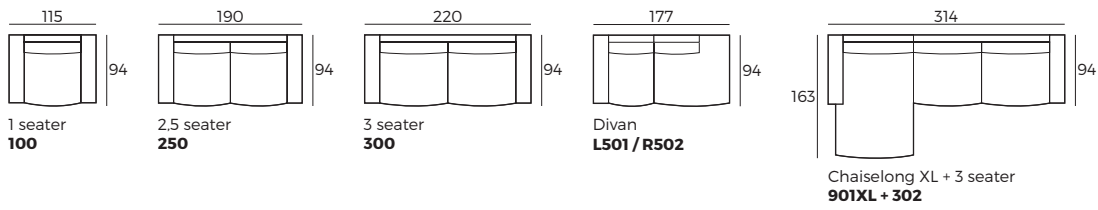

Accessories

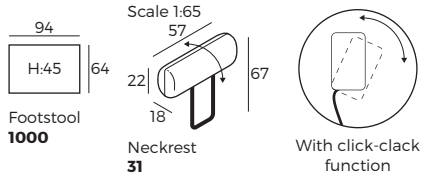

Suny



Suny



Comfort

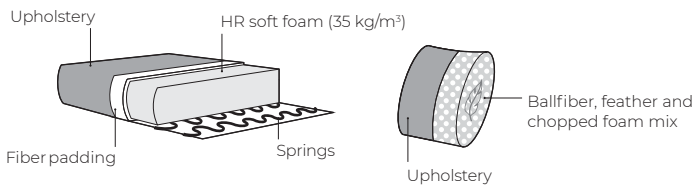

1. Upholstery



*Leather covers may require more stitches than fabric covers.

2. Legs



IMPORTANT:

Upholstered furniture is handmade using soft materials therefore measurements may vary up to +/- 5 cm.
Parts and sets shown in 2D drawings are left-sided. Parts and sets can be mirrored from left to right.

Single parts

Scale 1:100

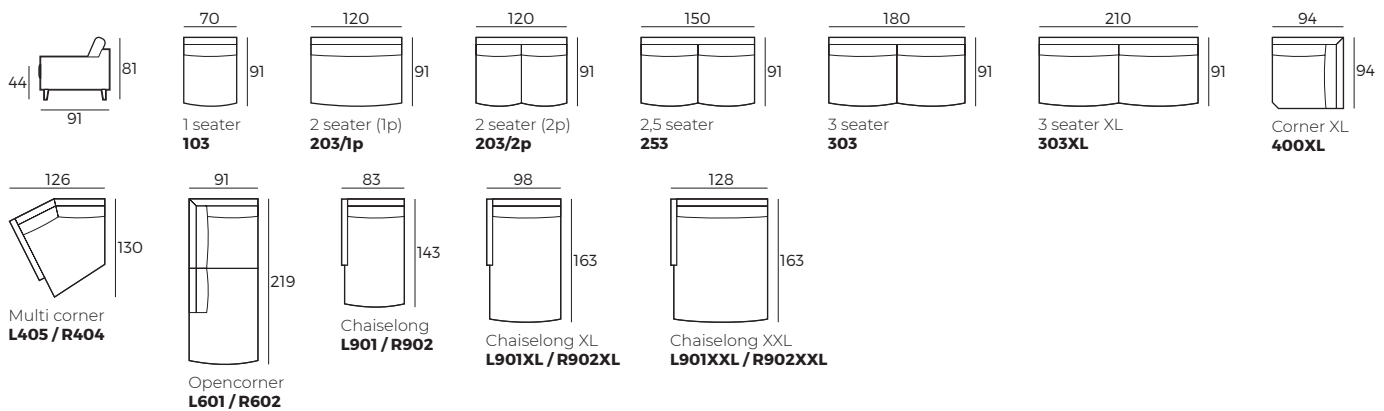

Suny

Scale 1:100

Half sets

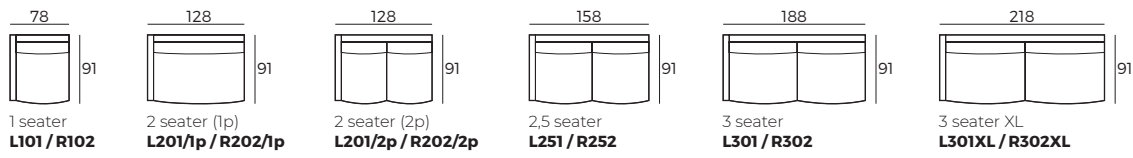

Sets

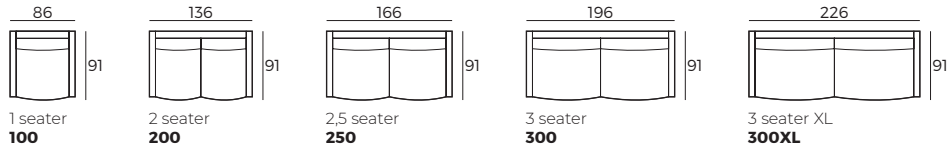

Accessories

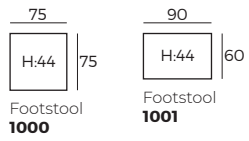

Synergie



Synergie



Comfort

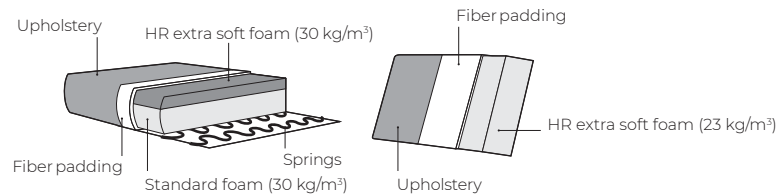

1. Upholstery



* Leather covers may require more stitches than fabric covers.

2. Headrest & seat type

*Measures with fully opened mechanism

- 1 Manual ↶ / Electrical ↷
- 2 Electrical ↷

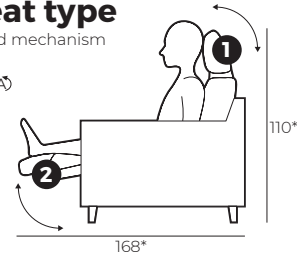

3. Armrest function



Fully closed W 11 x D 98 x H 66
Fully opened W 23 x D 98 x H 51

4. Bi-Color option

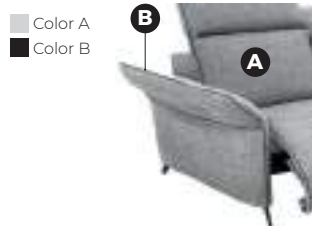

5. Legs



IMPORTANT:

Upholstered furniture is handmade using soft materials therefore measurements may vary up to +/- 5 cm.
 Parts and sets shown in 2D drawings are left-sided. Parts and sets can be mirrored from left to right.

Single parts (Measurements with fully opened armrest)

Scale 1:100

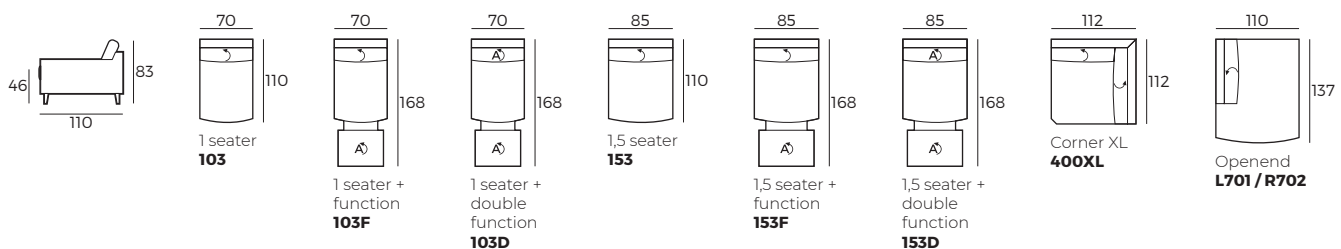

CUSTOM MADE COMFORT

Synergie

Single parts (Measurements with fully opened armrest)

Scale 1:100

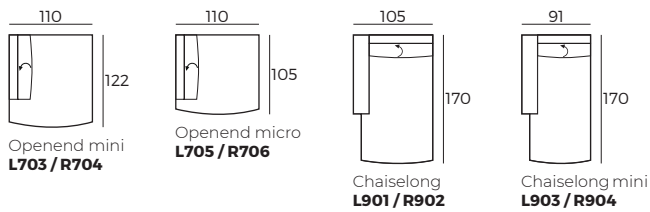

Half sets (Measurements with fully opened armrest)

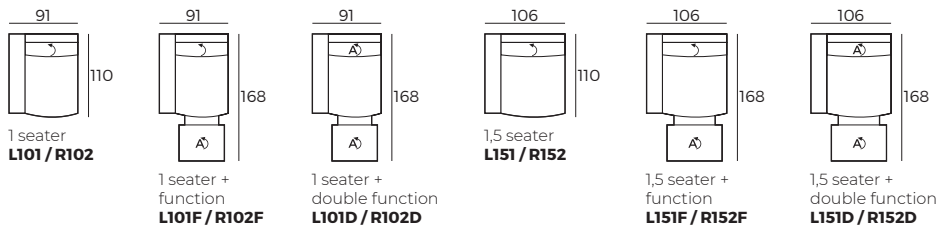

Sets (Measurements with fully opened armrest)

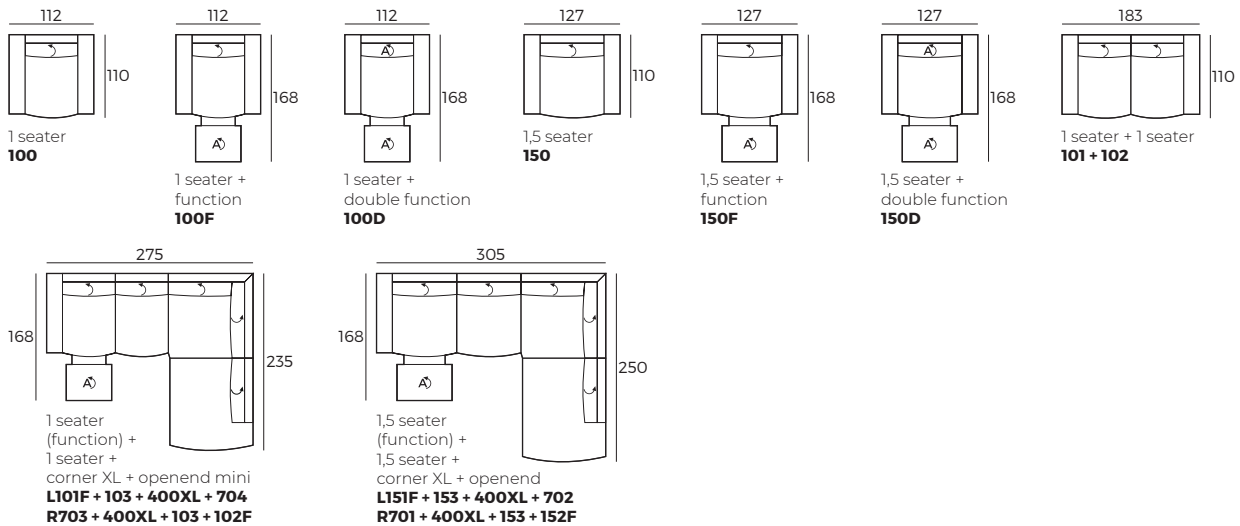

Accessories

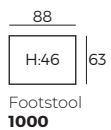

↶ - manual; ↷ - electrical *F - single electric function; *D - double electric function

Tailor S



Tailor S



Comfort

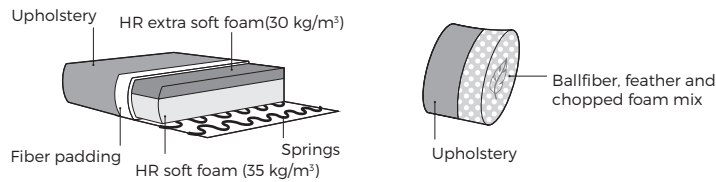

1. Upholstery



Fabric

2. Armrests



Street

W 23 x D 99 x H 52



Viggo

W 27 x D 99 x H 52

3. Legs

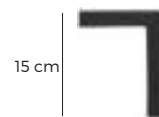

503
Black
Metal

IMPORTANT:

Upholstered furniture is handmade using soft materials therefore measurements may vary up to +/- 5 cm.
Parts and sets shown in 2D drawings are left-sided. Parts and sets can be mirrored from left to right.

Single parts (Measurements with Street armrest)

Scale 1:100

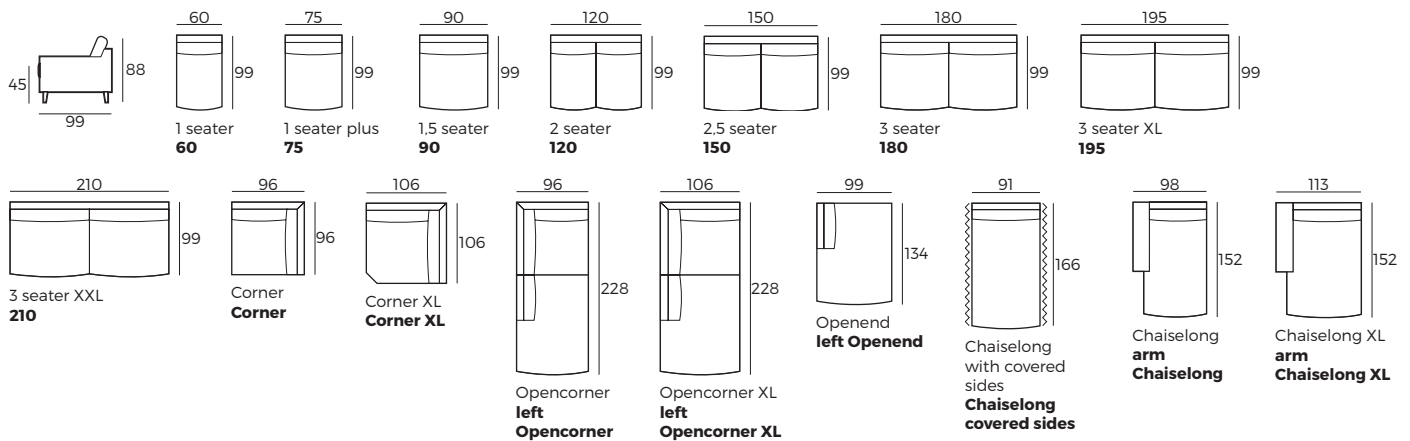

Tailor S

Half sets (Measurements with Street armrest)

Scale 1:100

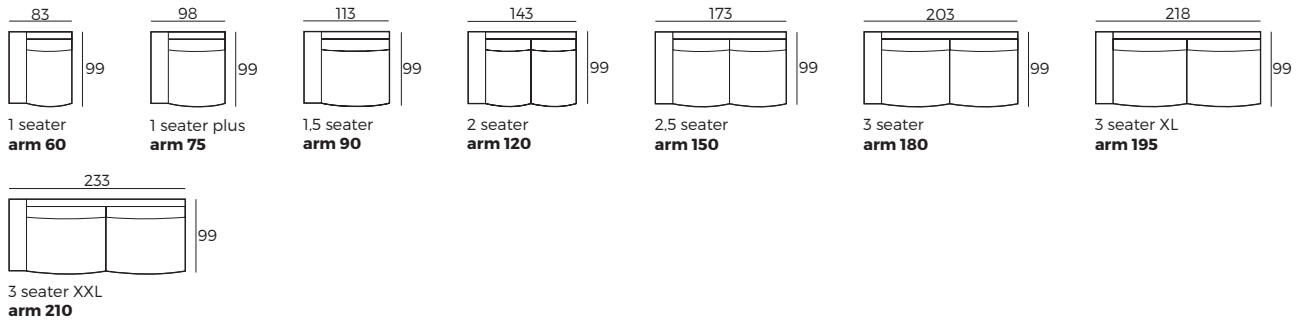

Sets (Measurements with Street armrest)

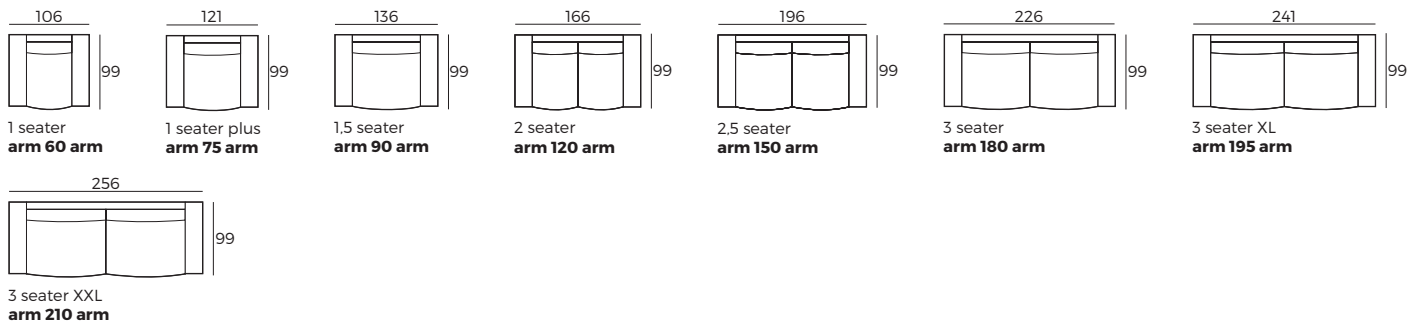

Accessories

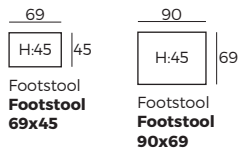

Toronto



Toronto



Comfort

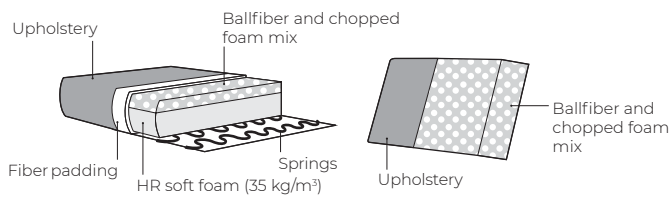

1. Upholstery



Fabric

2. Legs



IMPORTANT:

Upholstered furniture is handmade using soft materials therefore measurements may vary up to **+/- 5 cm**.
Parts and sets shown in 2D drawings are left-sided. Parts and sets can be mirrored from left to right.

Single parts

Scale 1:100

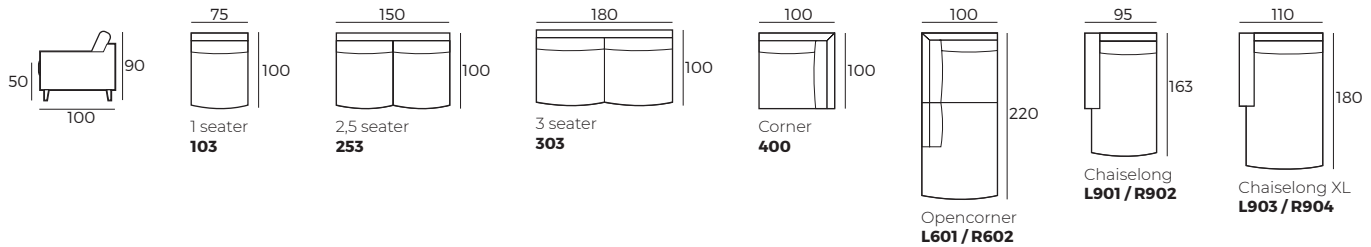

Half sets

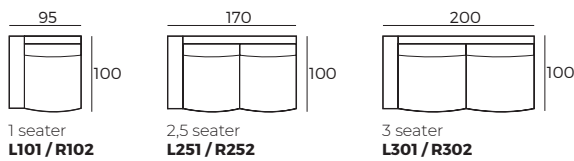

Sets

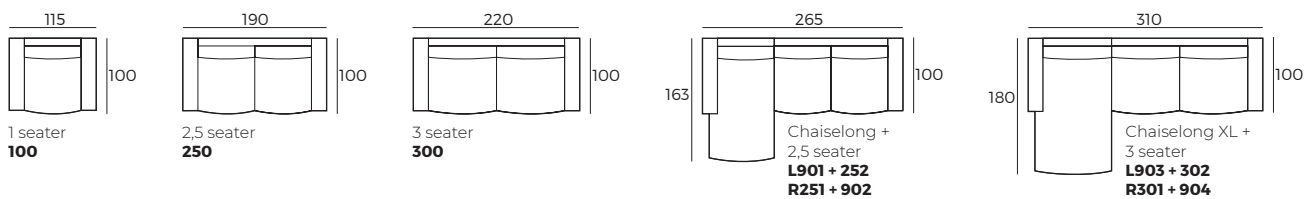

Toronto

Sets

Scale 1:100

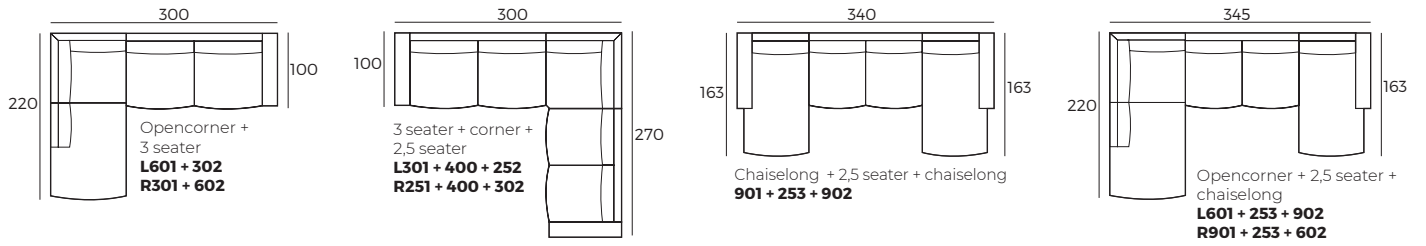

Accessories

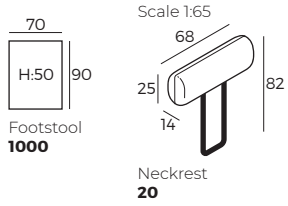

Tradition



Tradition



Comfort

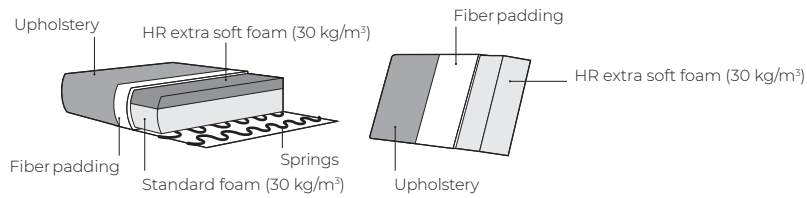

1. Upholstery



* Leather covers may require more stitches than fabric covers.

2. Headrest & seat type

*Measures with fully opened mechanism

- 1 Manual ↷ / Electrical ⤴
- 2 Electrical ⤴

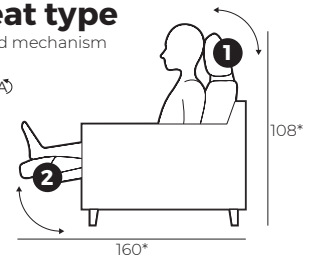

3. Bi-Color option

- Color A
- Color B



4. Armrest function



Fully closed W 11 x L 98 x H 66
Fully opened W 23 x L 98 x H 51

5. Legs



IMPORTANT:

Upholstered furniture is handmade using soft materials therefore measurements may vary up to +/- 5 cm.
 Parts and sets shown in 2D drawings are left-sided. Parts and sets can be mirrored from left to right.

Single parts (Measurements with fully opened armrest)

Scale 1:100

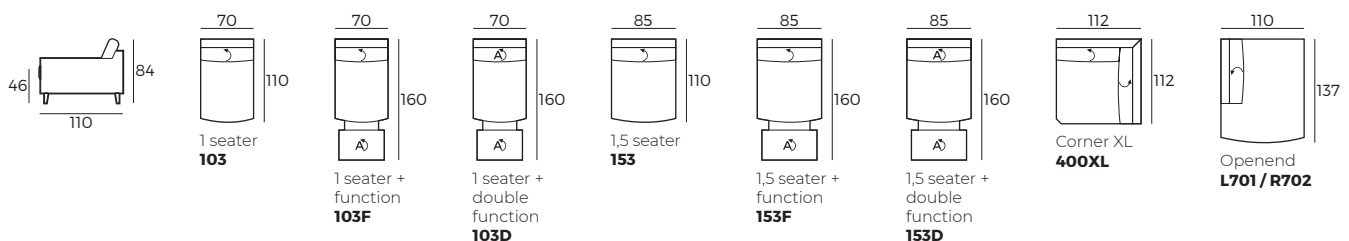

Tradition

Single parts (Measurements with fully opened armrest)

Scale 1:100

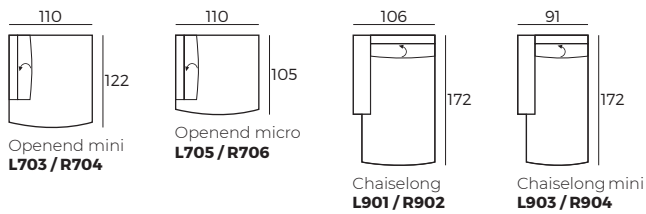

Half sets (Measurements with fully opened armrest)

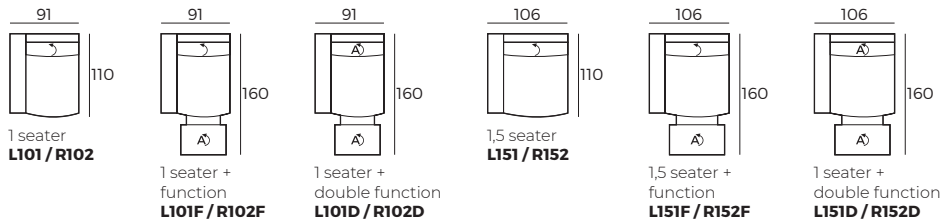

Sets (Measurements with fully opened armrest)

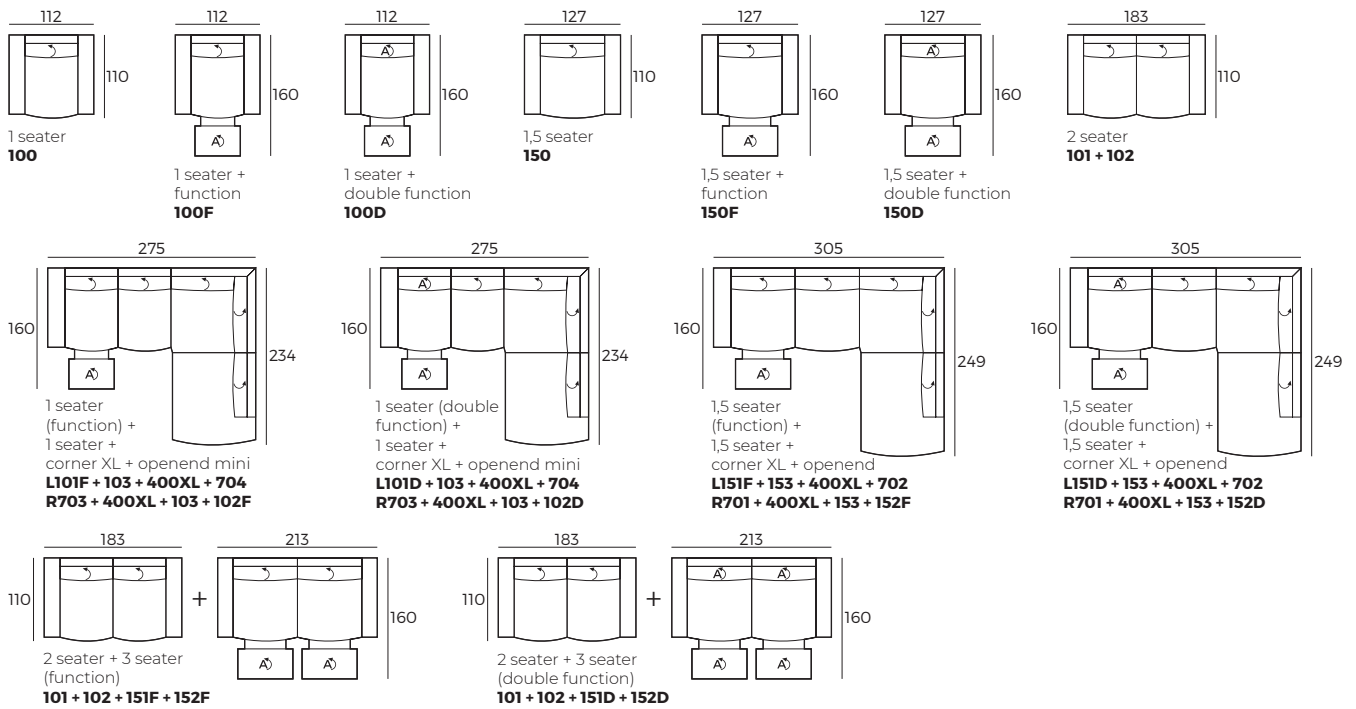

Accessories

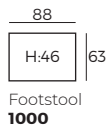

⤴ - manual; ⤵ - electrical *F - single electric function; *D - double electric function

U-design



U-design



Comfort

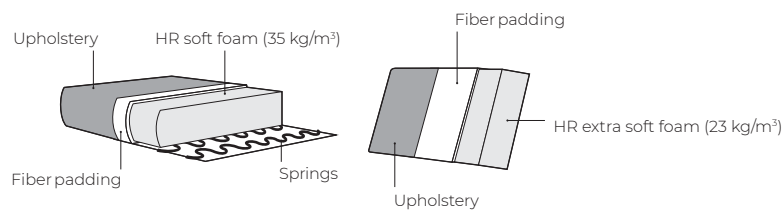

1. Upholstery



* Leather covers may require more stitches than fabric covers.

2. Armrests



A1 Width 9 cm
A2 Width 12 cm
A3 Width 16 cm

3. Front board

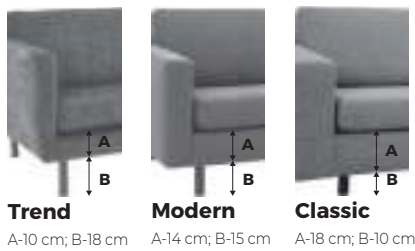

4. Legs

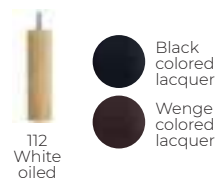

IMPORTANT:

Upholstered furniture is handmade using soft materials therefore measurements may vary up to +/- 5 cm.
 Parts and sets shown in 2D drawings are left-sided. Parts and sets can be mirrored from left to right.

Single parts

Scale 1:100

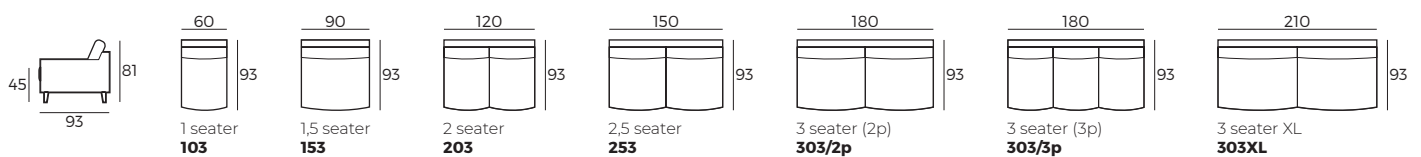

U-design

Scale 1:100

Single parts

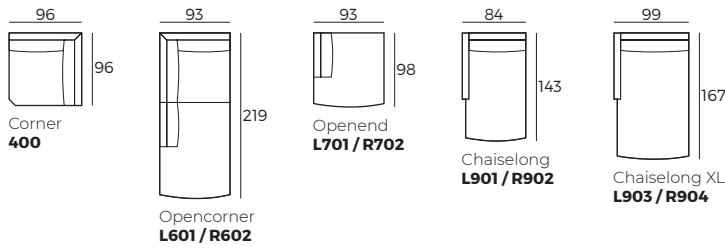

Half sets

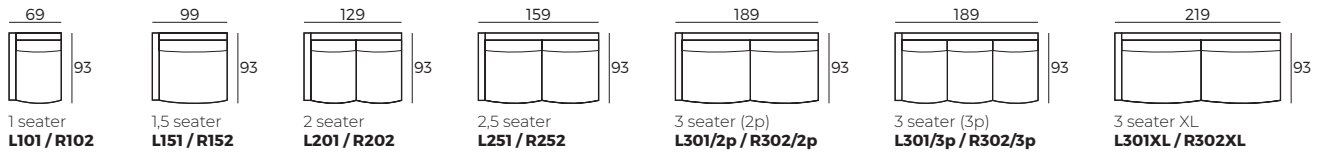

Sets

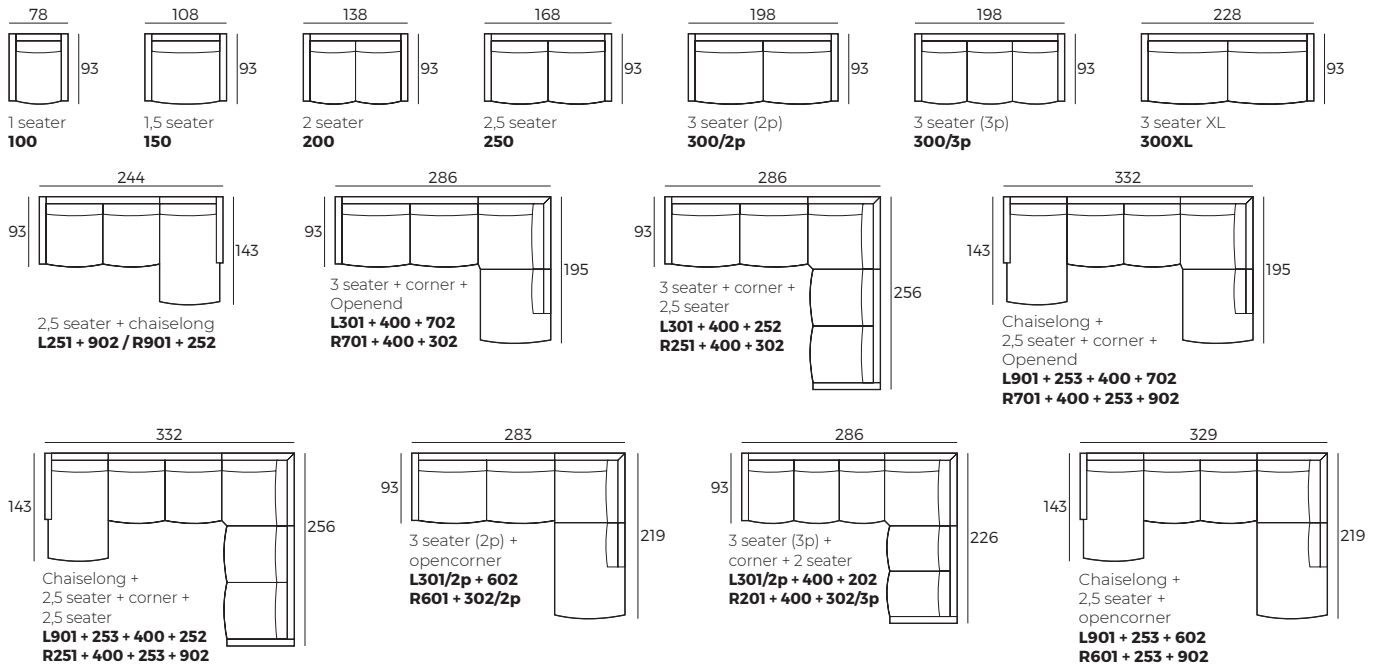

Accessories

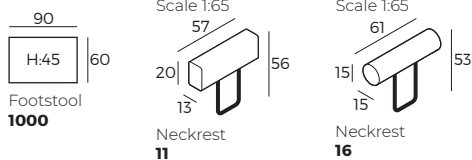

Unique



Unique



Comfort

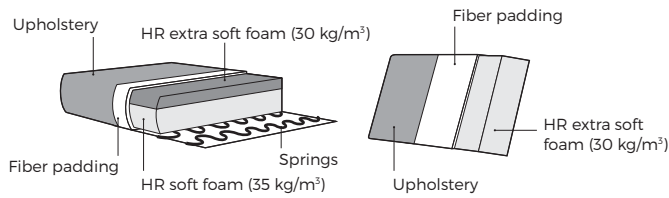

1. Upholstery



2. Headrest & seat type

*Measures with fully opened mechanism

- 1 Manual ↗
- 2 Electrical ↘

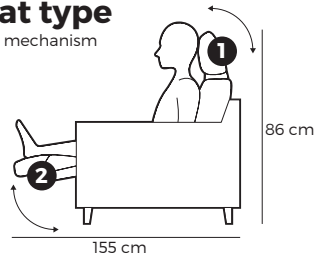

3. Legs

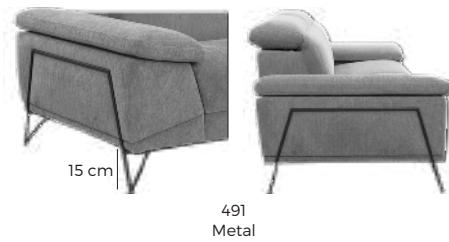

IMPORTANT:

Upholstered furniture is handmade using soft materials therefore measurements may vary up to +/- 5 cm.
Parts and sets shown in 2D drawings are left-sided. Parts and sets can be mirrored from left to right.

Single parts

Scale 1:100

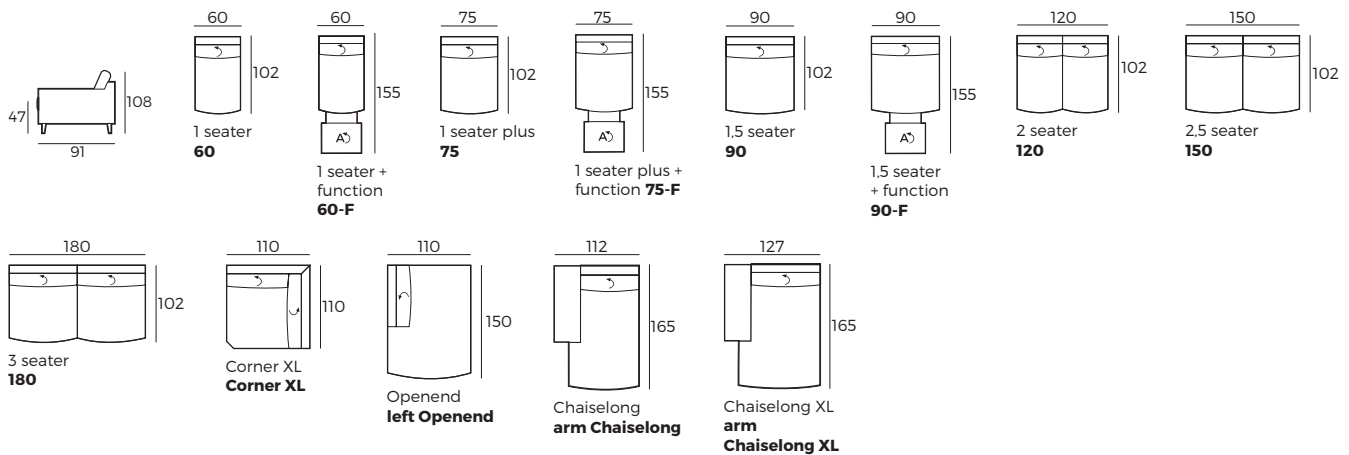

Unique

Half sets

Scale 1:100

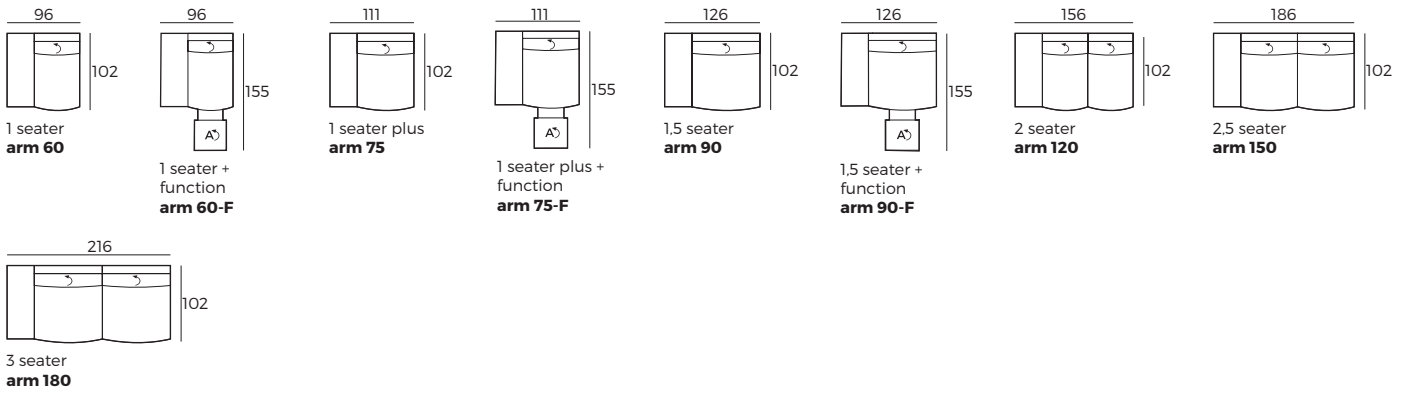

Sets

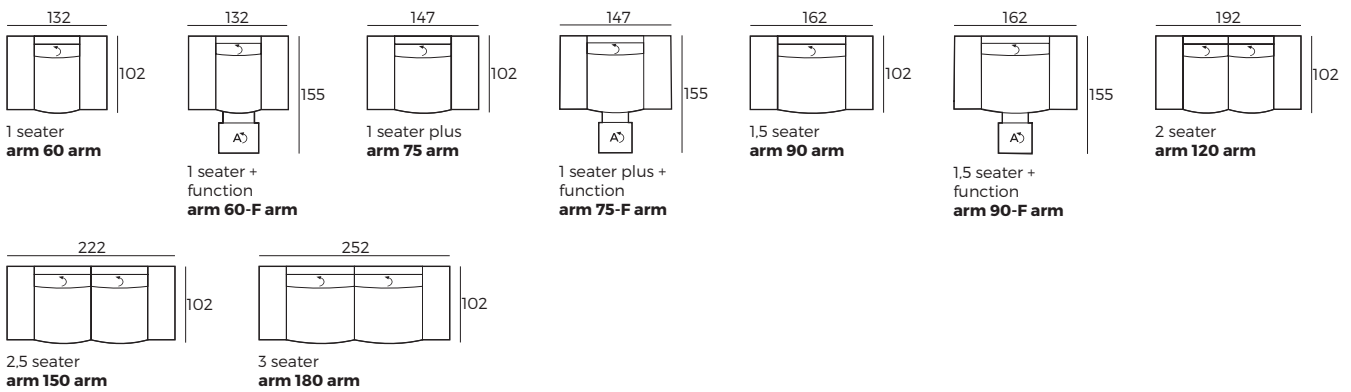

Accessories

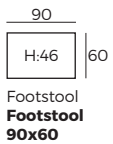

⌋ - manual; ⌋ - electrical *F - single electric function

Valdez



Valdez



Comfort

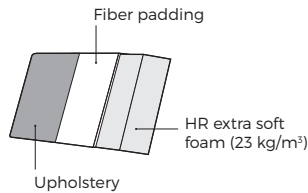
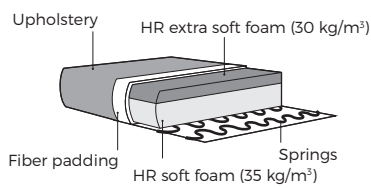

1. Upholstery



2. Legs



IMPORTANT:

Upholstered furniture is handmade using soft materials therefore measurements may vary up to +/- 5 cm.
Parts and sets shown in 2D drawings are left-sided. Parts and sets can be mirrored from left to right.

Single parts

Scale 1:100

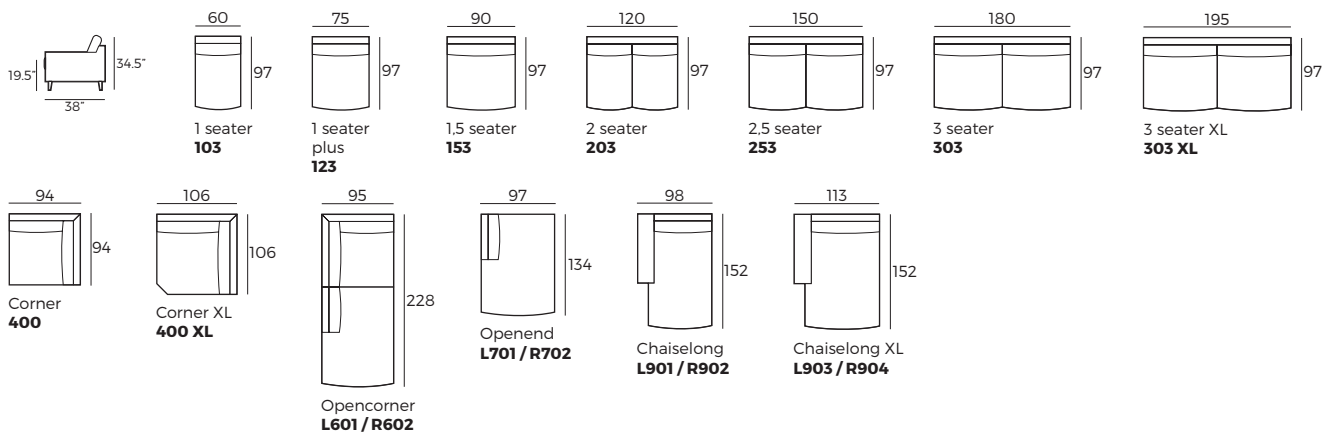

Half sets

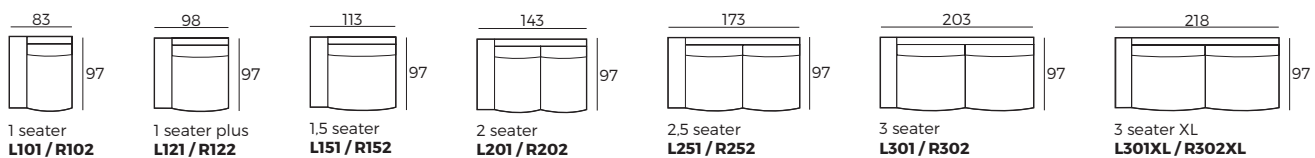

CUSTOM MADE COMFORT

Valdez

Sets

Scale 1:100

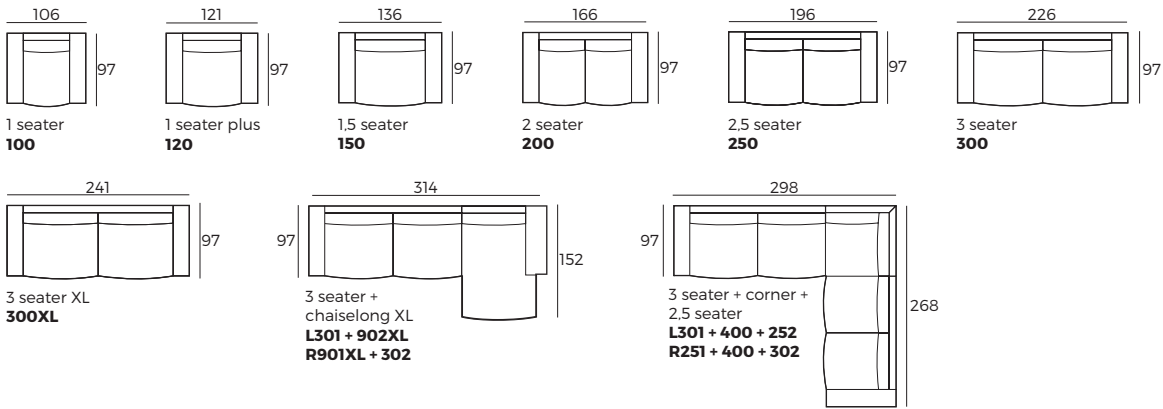

Accessories

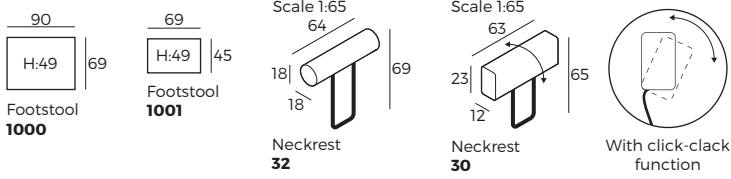

Viggo



Viggo



Comfort

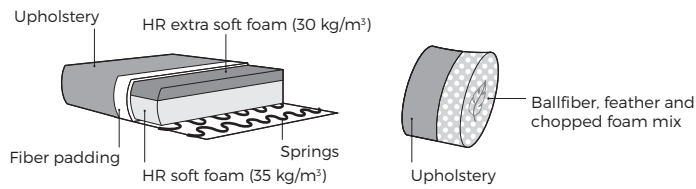

1. Upholstery

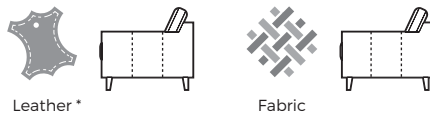

* Leather and fabric upholstery contains the same number of stitches.

2. Legs



IMPORTANT:

Upholstered furniture is handmade using soft materials therefore measurements may vary up to +/- 5 cm.
Parts and sets shown in 2D drawings are left-sided. Parts and sets can be mirrored from left to right.

Single parts

Scale 1:100

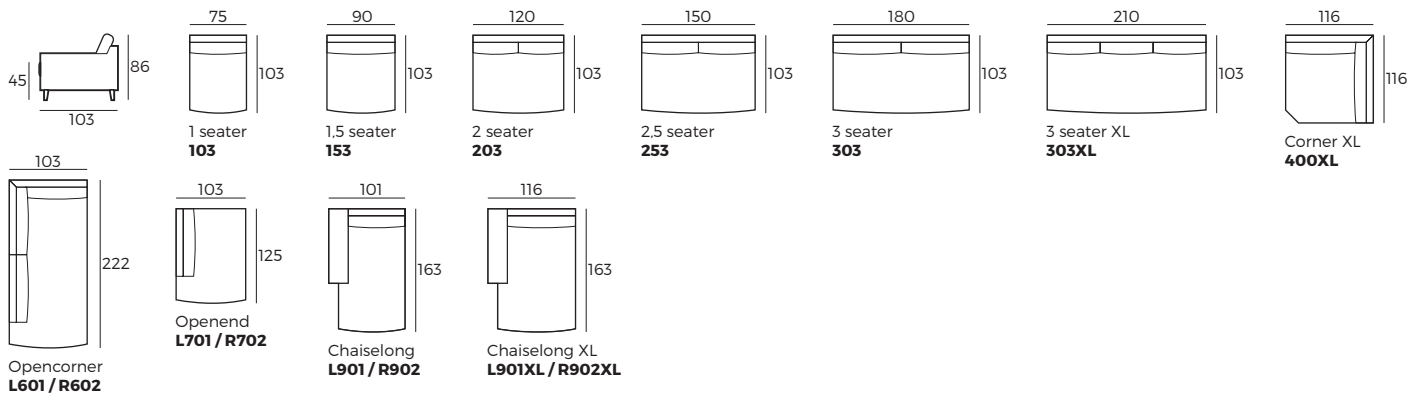

Viggo

Half sets

Scale 1:100

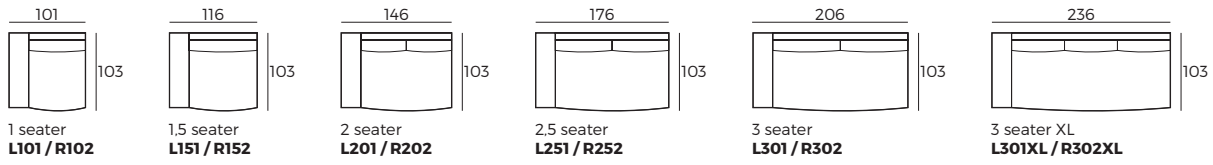

Sets

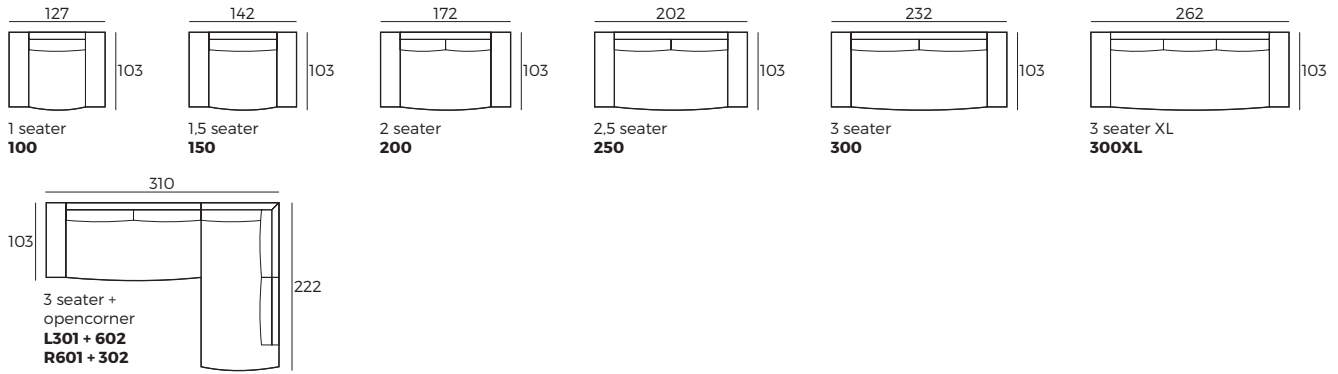

Accessories

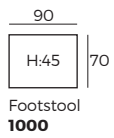

Wilson



Wilson



Comfort

1. Upholstery

2. Legs

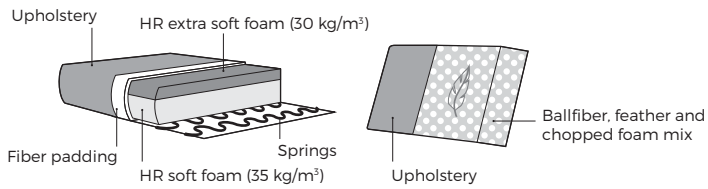

Fabric



441 Black colored lacquer



White oiled

IMPORTANT:

Upholstered furniture is handmade using soft materials therefore measurements may vary up to +/- 5 cm.
Parts and sets shown in 2D drawings are left-sided. Parts and sets can be mirrored from left to right.

Single parts

Scale 1:100

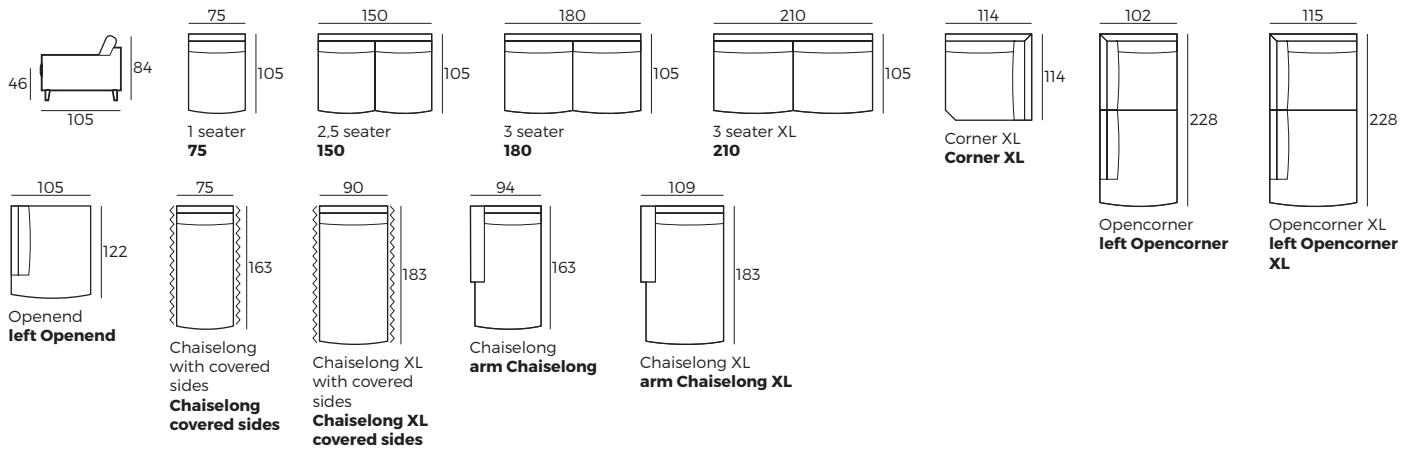

Half sets

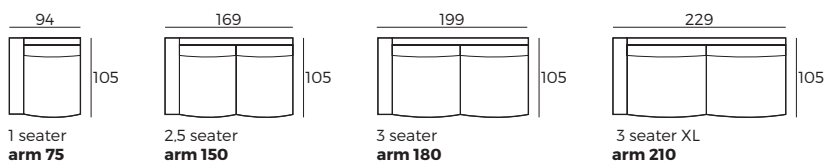

Sets

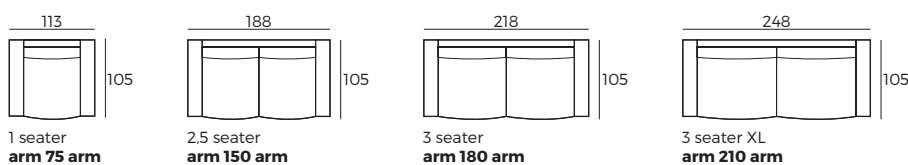

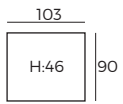

Footstool
Footstool
103x90

Yeva



Yeva



Comfort

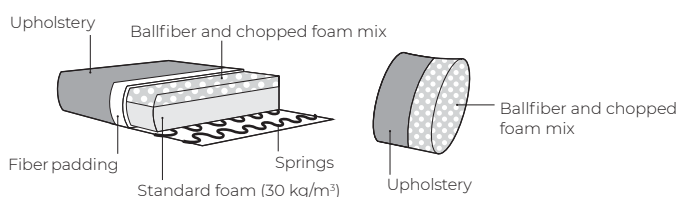

1. Upholstery



2. Legs



IMPORTANT:

Upholstered furniture is handmade using soft materials therefore measurements may vary up to +/- 5 cm.
Parts and sets shown in 2D drawings are left-sided. Parts and sets can be mirrored from left to right.

Sets

Scale 1:100

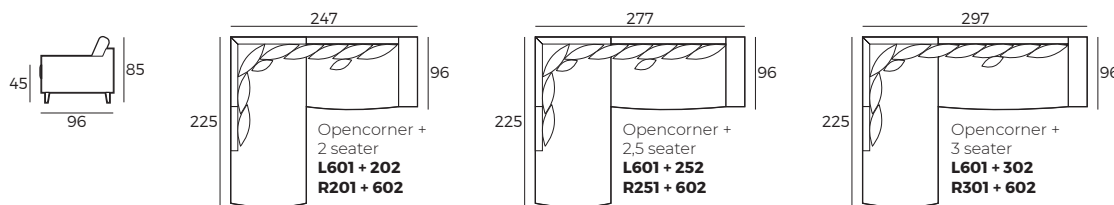

Accessories

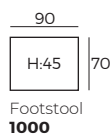

Grace, Jana



Grace, Jana

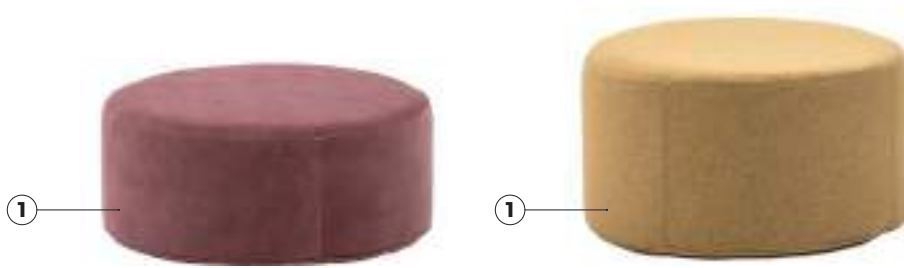

Comfort

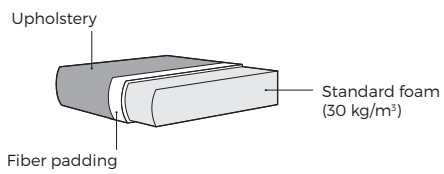

1. Upholstery

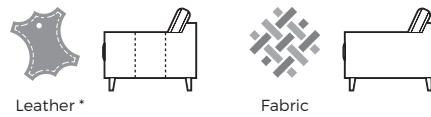

* Leather covers may require more stitches than fabric covers.

IMPORTANT:

Upholstered furniture is handmade using soft materials therefore measurements may vary up to **+/- 5 cm**.

Measurements

Scale 1:35

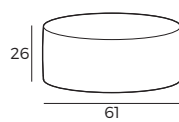

Grace footstool
1000

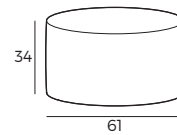

Jana footstool
1001

Orlando



Orlando



Comfort

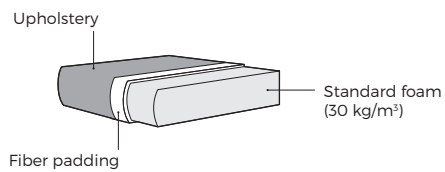

1. Upholstery

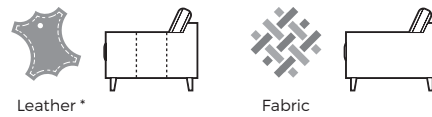

* Leather covers may require more stitches than fabric covers.

2. Top colors

Composition:
oak veneered chipboard

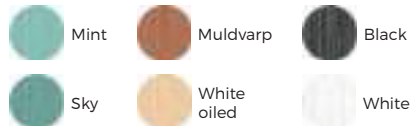

IMPORTANT:

Upholstered furniture is handmade using soft materials therefore measurements may vary up to +/- 5 cm.

Measurements

Scale 1:35

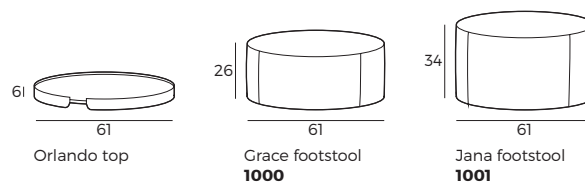

Sets

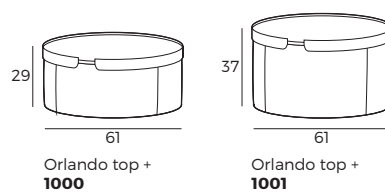

CUSTOM MADE COMFORT

Deco cushions



Deco cushions

Measurements / Comfort

Scale 1:30

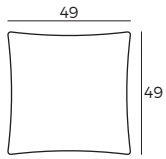

With piping
C001

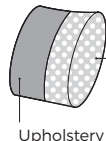

Upholstery

70% chopped foam and
30% ballfiber and mix

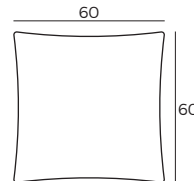

Regular
C009

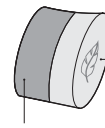

Upholstery

Feather

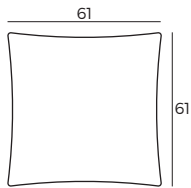

With piping
C002

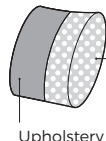

Upholstery

70% chopped foam and
30% ballfiber and mix

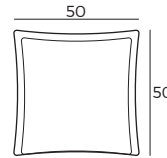

With wings
C010

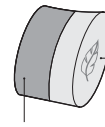

Upholstery

Feather

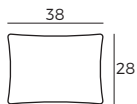

Regular
C003

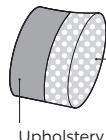

Upholstery

50% ballfiber and 50% chopped
foam mix

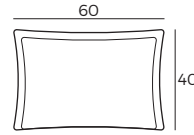

With wings
C011

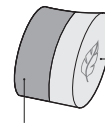

Upholstery

Feather

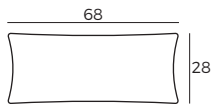

With a belt
C004

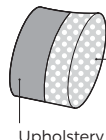

Upholstery

50% ballfiber and 50% chopped
foam mix

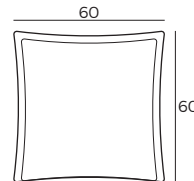

With wings
C012

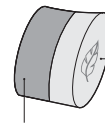

Upholstery

Feather

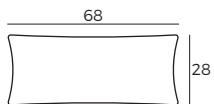

Regular
C005

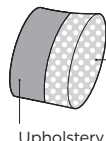

Upholstery

50% ballfiber and 50% chopped
foam mix

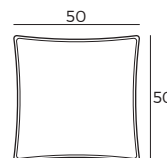

With the French
seam
C014

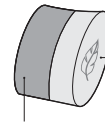

Upholstery

Feather

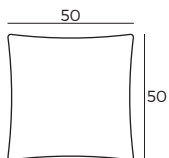

Regular
C007

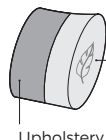

Upholstery

Feather

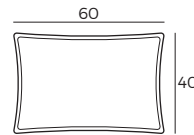

With the French
seam
C015

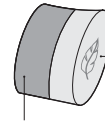

Upholstery

Feather

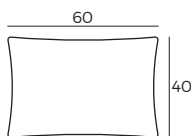

Regular
C008

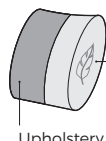

Upholstery

Feather

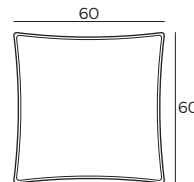

With the French
seam
C016

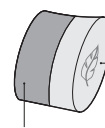

Upholstery

Feather

IMPORTANT:

Upholstered furniture is handmade using soft materials therefore measurements may vary up to **+/- 5 cm**.

CUSTOM MADE COMFORT



Regular

With piping

With wings



With a belt

With the French seam

Neckrest



Neckrest

IMPORTANT:

Upholstered furniture is handmade using soft materials therefore measurements may vary up to +/- 5 cm.

No. 11



Comfort

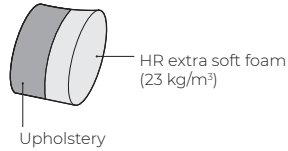

Upholstery



Measurements

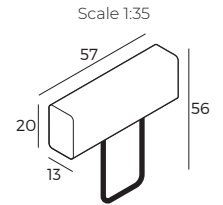

No. 12

Portable armrest



Comfort

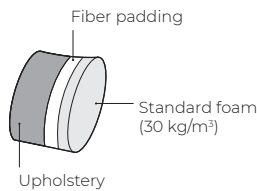

Upholstery



Measurements

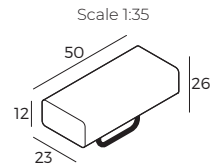

No. 16



Comfort

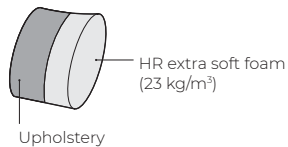

Upholstery



Measurements

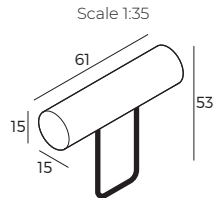

No. 18

Suitable only for Mantanas



Comfort

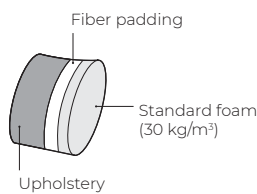

Upholstery



Measurements

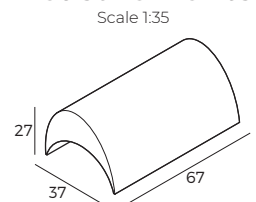

Neckrest

No. 19

Suitable only for Mantanas



Comfort

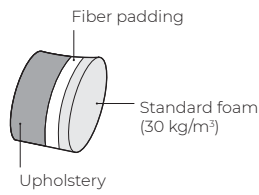

Upholstery



Measurements

Scale 1:35

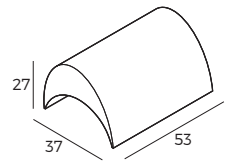

No. 20



Comfort

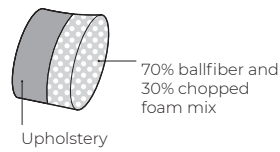

Upholstery



Measurements

Scale 1:35

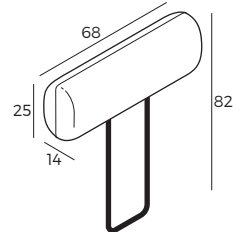

No. 21



Comfort

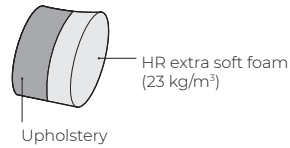

Upholstery



Measurements

Scale 1:35

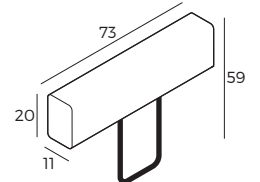

No. 23



Comfort

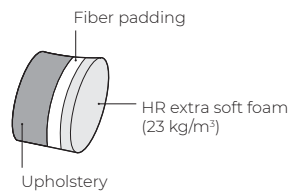

Upholstery



Measurements

Scale 1:35

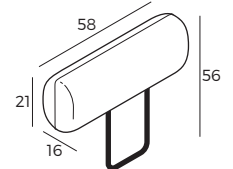

Neckrest

No. 24



Comfort

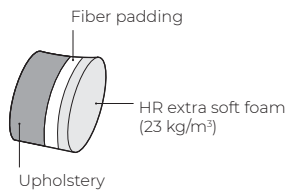

Upholstery



Measurements

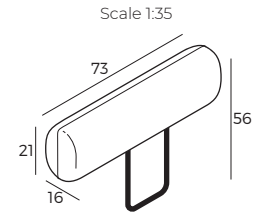

No. 29



Comfort

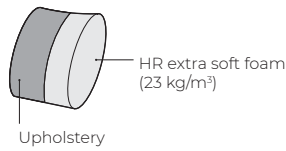

Upholstery



Measurements

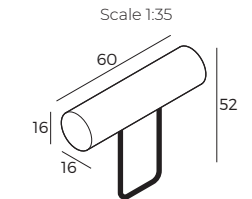

No. 30



Comfort

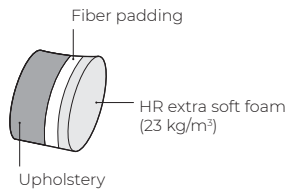

Upholstery



Measurements

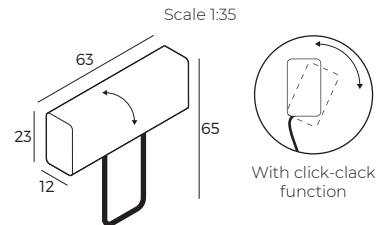

No. 31



Comfort

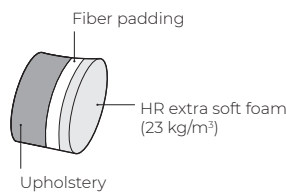

Upholstery



Measurements

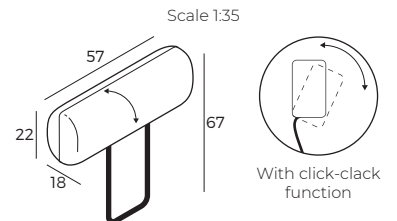

Neckrest

No. 32



Comfort

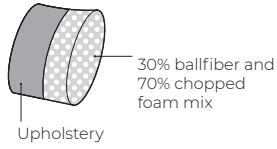

Upholstery



Measurements

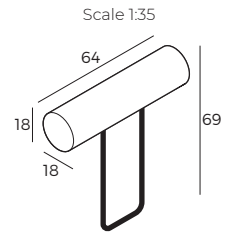

No. 35



Comfort

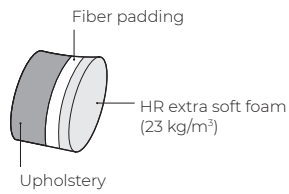

Upholstery



Measurements

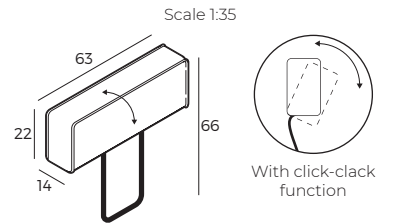

Colin



Colin



Comfort

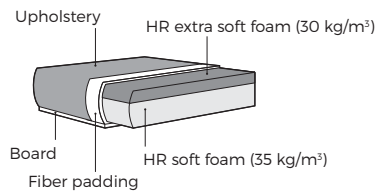

1. Upholstery

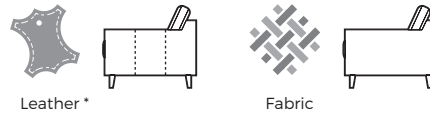

* Leather covers may require more stitches than fabric covers.

IMPORTANT:

Upholstered furniture is handmade using soft materials therefore measurements may vary up to **+/- 5 cm**.

Measurements

Scale 1:35

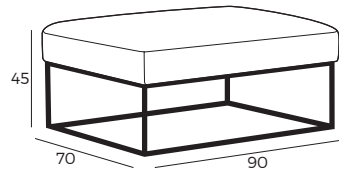

CUSTOM MADE COMFORT

Marc, Paul



Marc, Paul

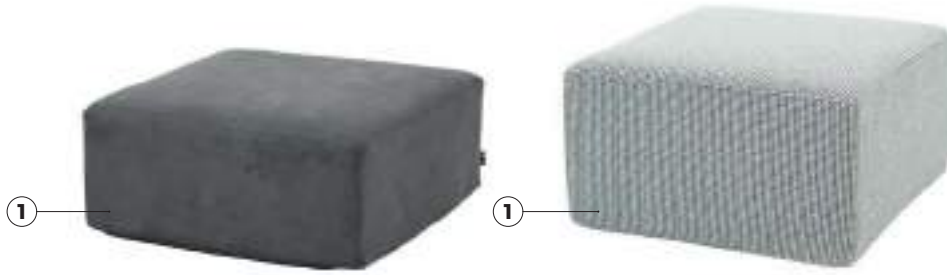

Comfort

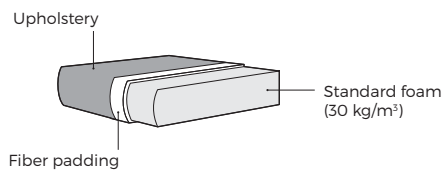

1. Upholstery

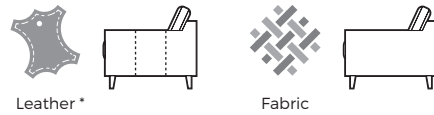

* Leather covers may require more stitches than fabric covers.

IMPORTANT:

Upholstered furniture is handmade using soft materials therefore measurements may vary up to **+/- 5 cm**.

Measurements

Scale 1:35

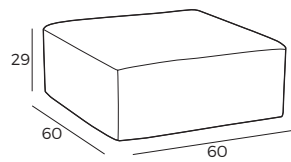

Marc
1000

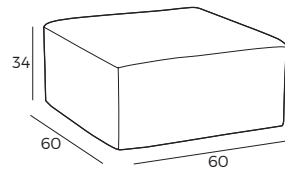

Paul
1001

Square, Round



Square, Round



Comfort

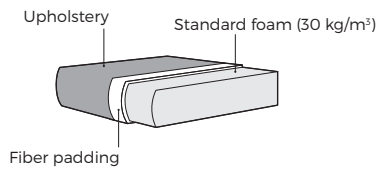

1. Upholstery

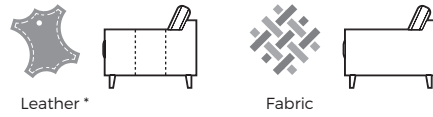

* Leather covers may require more stitches than fabric covers.

IMPORTANT:

Upholstered furniture is handmade using soft materials therefore measurements may vary up to +/- 5 cm.

Measurements

Scale 1:35

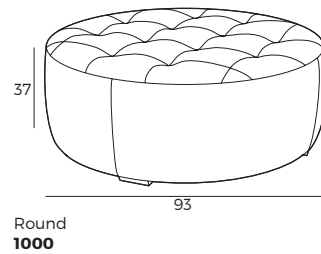
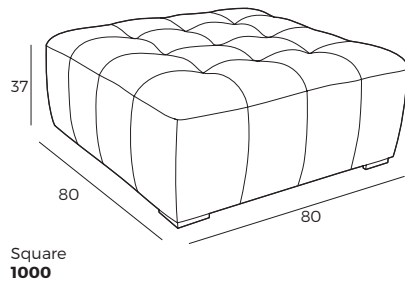

6 AM



6 AM



Comfort

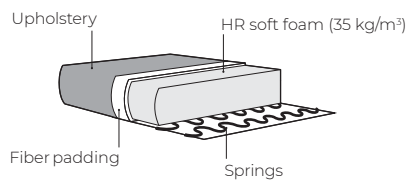

1. Upholstery



Fabric

3. Legs

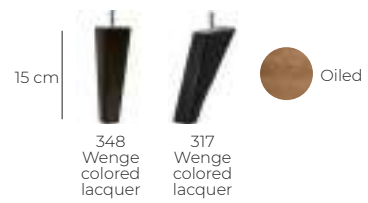

IMPORTANT:

Upholstered furniture is handmade using soft materials therefore measurements may vary up to **+/- 5 cm**.

Measurements

Scale 1:35

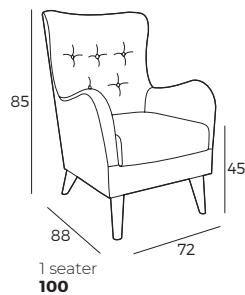

Cher



Cher



Comfort

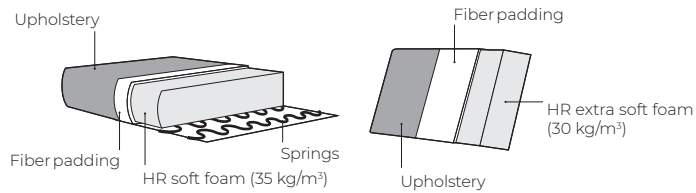

Head pillow



1. Upholstery

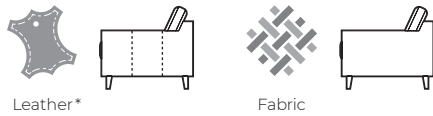

Leather*

Fabric

* Leather covers may require more stitches than fabric covers.

2. Functions



3 - Button function command

3. Headrest & seat functions



Conical stop 340°
Drop mount



Back function
Electrical

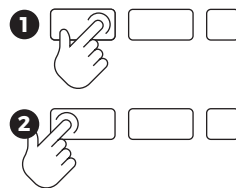

Footrest function
Electrical

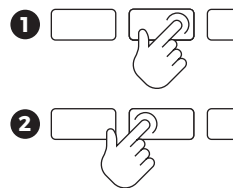

Headrest function
Mechanical

Return to starting position

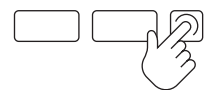

Cher

IMPORTANT:

Upholstered furniture is handmade using soft materials therefore measurements may vary up to **+/- 5 cm**.

Measurements

Scale 1:35

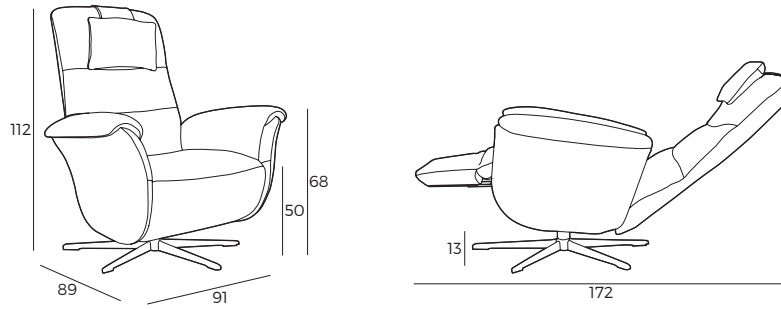

Chess



Chess



Comfort

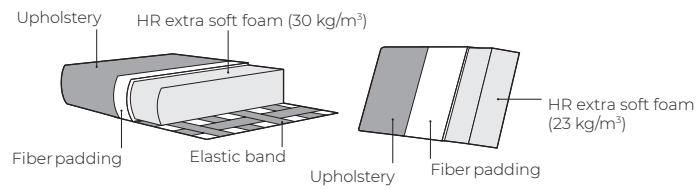

1. Upholstery



Leather*

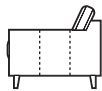

Fabric

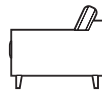

* Leather covers may require more stitches than fabric covers.

2. Legs

12 cm



394
Black
metal

IMPORTANT:

Upholstered furniture is handmade using soft materials therefore measurements may vary up to **+/- 5 cm**.

Measurements

Scale 1:35

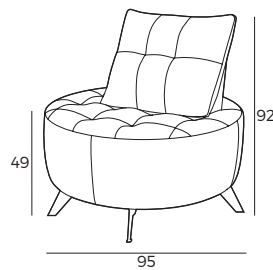

Chilla / Snow



Chilla / Snow



Comfort

CHILLA

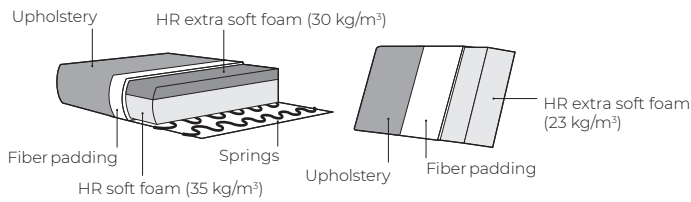

SNOW

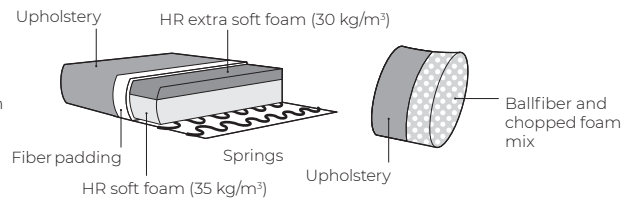

1. Upholstery



Leather*

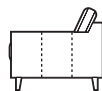

Fabric

* Leather covers may require more stitches than fabric covers.

2. Legs



191 Oiled



230 Oiled



Black colored lacquer

IMPORTANT:

Upholstered furniture is handmade using soft materials therefore measurements may vary up to +/- 5 cm.

Measurements

Scale 1:35

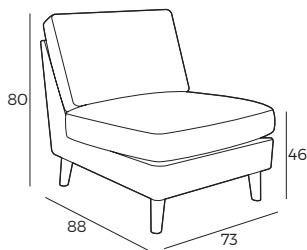

Chilla
100

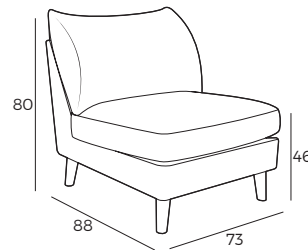

Snow
100

Polo



Polo



Comfort

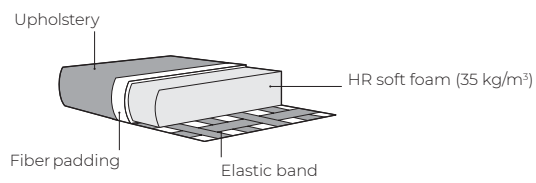

1. Upholstery



Leather*



Fabric



*Leather covers may require more stitches than fabric covers.

2. Legs



Black colored lacquer

IMPORTANT:

Upholstered furniture is handmade using soft materials therefore measurements may vary up to **+/- 5 cm**.

Measurements

Scale 1:35

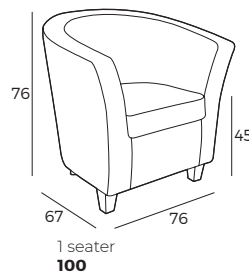

Desire



Desire



Comfort

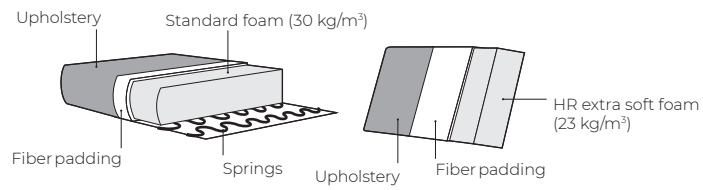

1. Upholstery



Fabric

2. Legs



IMPORTANT:

Upholstered furniture is handmade using soft materials therefore measurements may vary up to +/- 5 cm.

Measurements

Scale 1:35

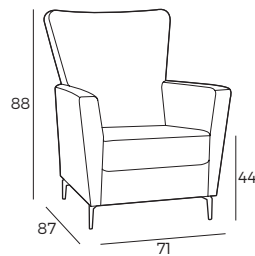

1 seater
100

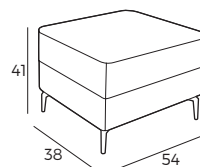

Footstool
1000

CUSTOM MADE COMFORT

Dream



Dream



Comfort

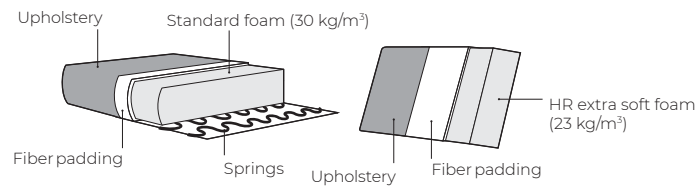

1. Upholstery



Leather *

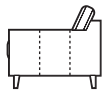

Fabric

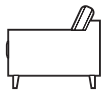

* Leather covers may require more stitches than fabric covers.

2. Legs

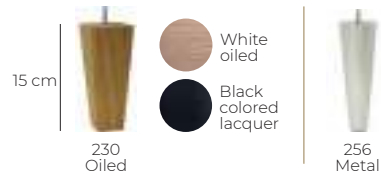

IMPORTANT:

Upholstered furniture is handmade using soft materials therefore measurements may vary up to +/- 5 cm.

Measurements

Scale 1:35

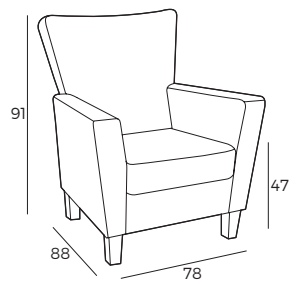

1 seater
100

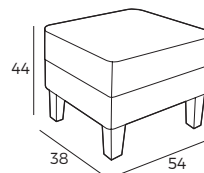

Footstool
1000

CUSTOM MADE COMFORT

Lilla



Lilla



Comfort

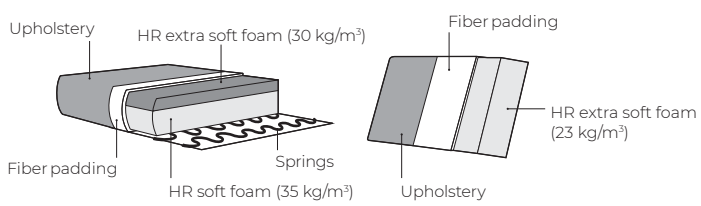

1. Upholstery



Fabric

2. Legs



IMPORTANT:

Upholstered furniture is handmade using soft materials therefore measurements may vary up to **+/- 5 cm**.

Measurements

Scale 1:35

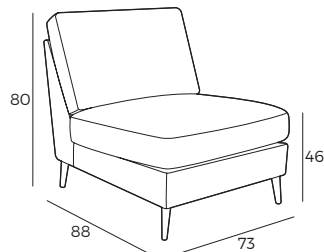

CUSTOM MADE COMFORT

Liza / Suva



Liza / Suva



LIZA

Comfort

SUVA

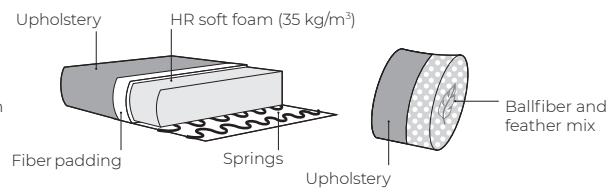
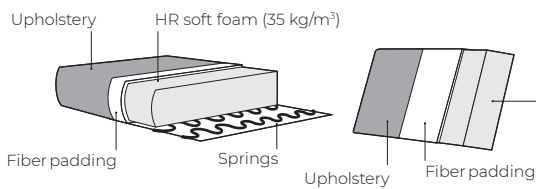

1. Upholstery



2. Legs

LIZA



SUVA



IMPORTANT:

Upholstered furniture is handmade using soft materials therefore measurements may vary up to +/- 5 cm.

Measurements

Scale 1:35

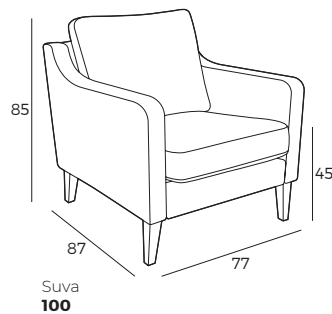
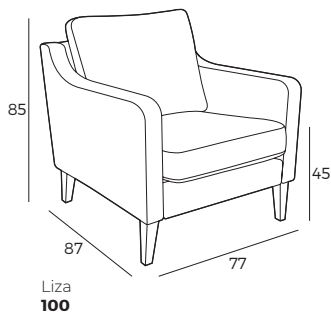

Luca



Luca



Comfort

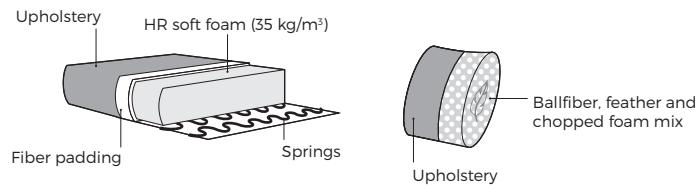

1. Upholstery



Fabric

2. Legs



IMPORTANT:

Upholstered furniture is handmade using soft materials therefore measurements may vary up to +/- 5 cm.

Measurements

Scale 1:35

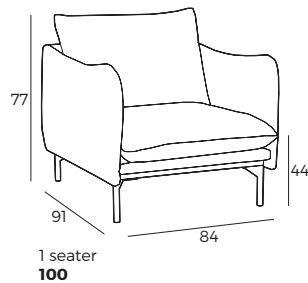

Nell



Nell



Comfort

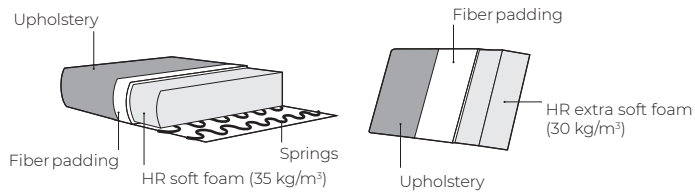

1. Upholstery



Leather*

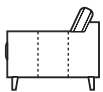

Fabric

* Leather covers may require more stitches than fabric covers.

2. Bi-Color option

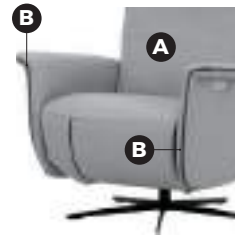

3. Functions



3 - Button function command

4. Headrest & seat functions



Conical stop 340°
Drop mount



Back function
Electrical

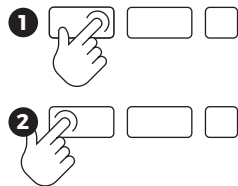

Footrest function
Electrical

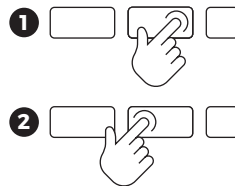

Headrest function
Mechanical

Return to starting position

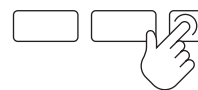

Nell

IMPORTANT:

Upholstered furniture is handmade using soft materials therefore measurements may vary up to **+/- 5 cm.**

Measurements

Scale 1:35

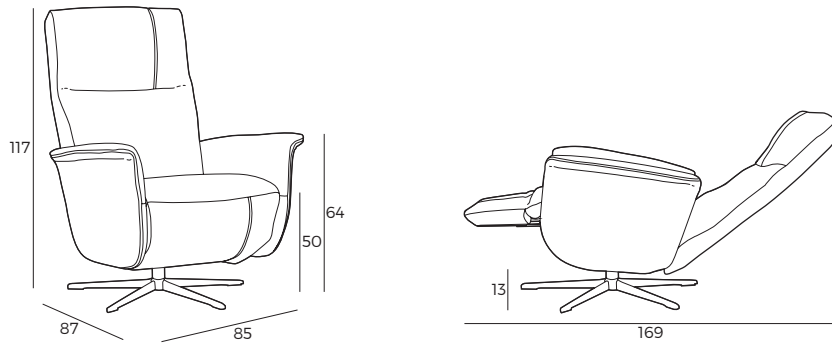

Rela



Rela



Comfort

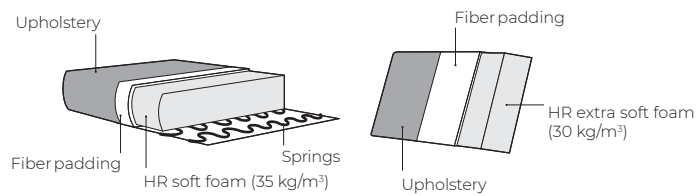

1. Upholstery



* Leather covers may require more stitches than fabric covers.

2. Functions



3 - Button function command

3. Headrest & seat functions



Conical stop 340°
Drop mount

Return to starting position

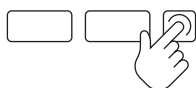

Back function
Electrical

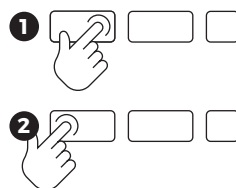

Footrest function
Electrical

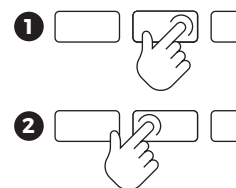

Rela

IMPORTANT:

Upholstered furniture is handmade using soft materials therefore measurements may vary up to **+/- 5 cm**.

Measurements

Scale 1:35

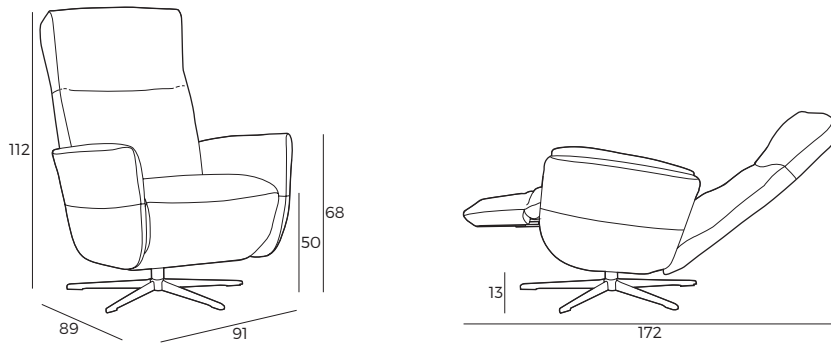

Vector



Vector



Comfort

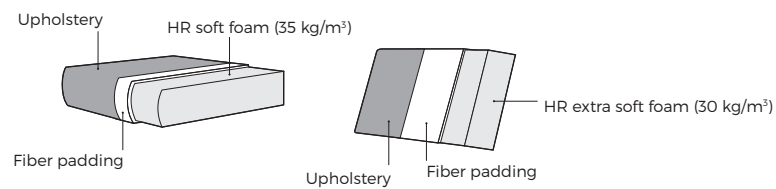

1. Upholstery

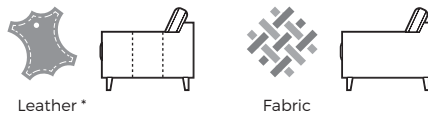

* Leather covers may require more stitches than fabric covers.

IMPORTANT:

Upholstered furniture is handmade using soft materials therefore measurements may vary up to **+/- 5 cm**.

Measurements

Scale 1:35

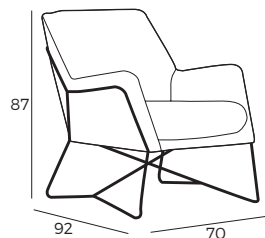

Vinta



Vinta



Comfort

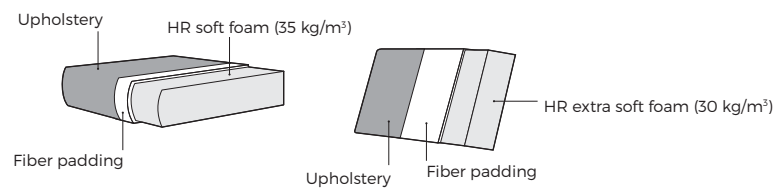

1. Upholstery



* Leather covers may require more stitches than fabric covers.

IMPORTANT:

Upholstered furniture is handmade using soft materials therefore measurements may vary up to +/- 5 cm.

Measurements

Scale 1:35

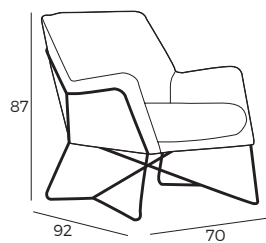

Chair
100

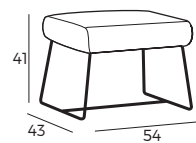

Footstool
1000